

UBGOG601BK

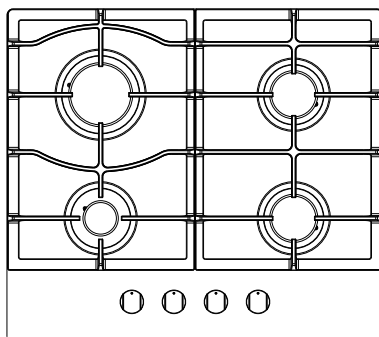

UBGOG701BK

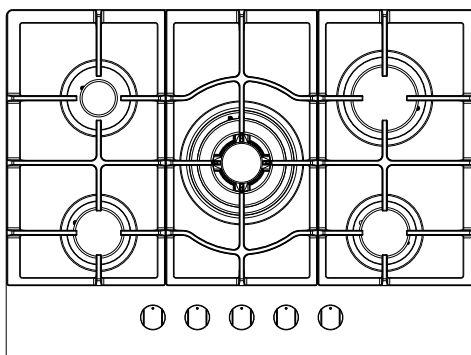

UBGOG901BK

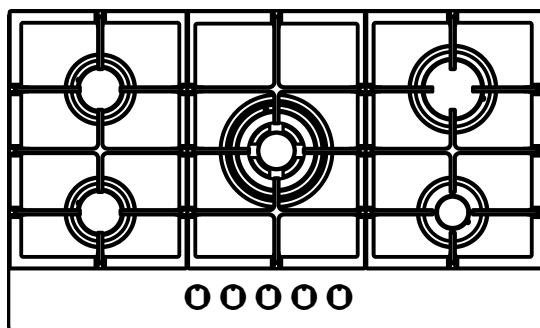

UBGOG601BK

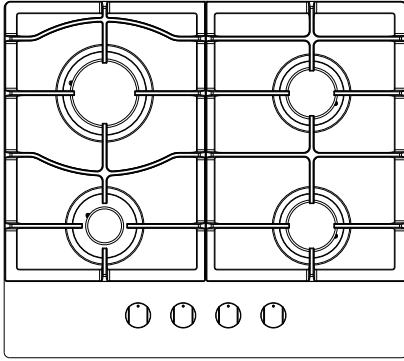

[01] x 1

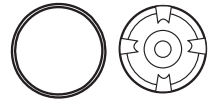

[03] x 1



[04] x 2



[05] x 1

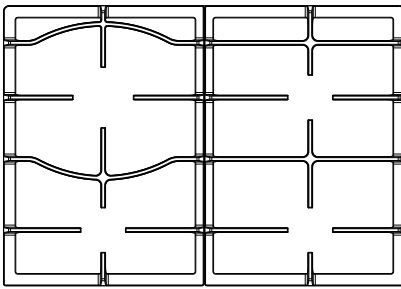

[06] x 1 set



[07] x 1



[08] x 3

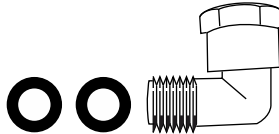

[09] x 1set

1 : 1

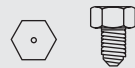

[10] x 4



[11] x 3



[12] x 1

UBGOG701BK

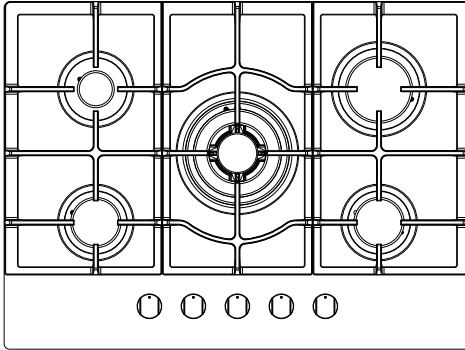

[01] x 1

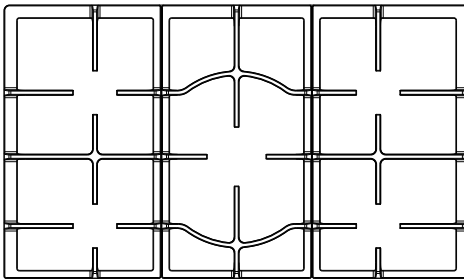

[06] x 1 set



[07] x 1



[08] x 4

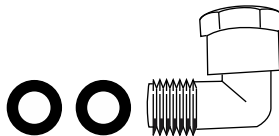

[09] x 1set

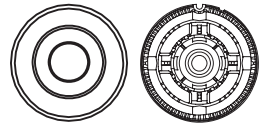

[02] x 1

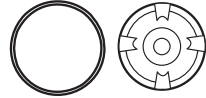

[03] x 1

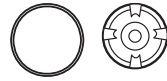

[04] x 2



[05] x 1

1 : 1

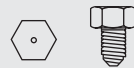

[10] x 5



[11] x 4



[12] x 1

UBGOG901BK

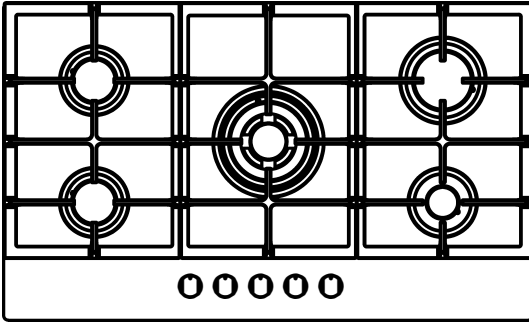

[01] x 1

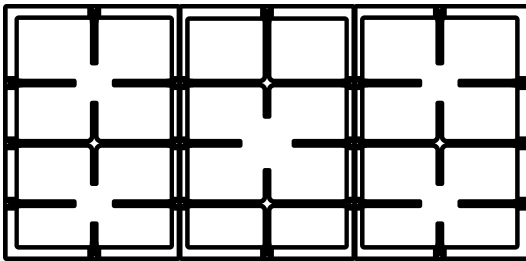

[06] x 1 set



[07] x 1



[08] x 4

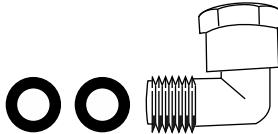

[09] x 1set

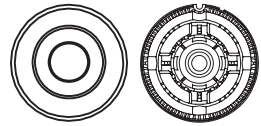

[02] x 1

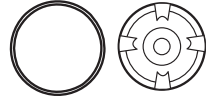

[03] x 1

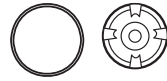

[04] x 2



[05] x 1

1 : 1

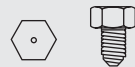

[10] x 5



[11] x 4



[12] x 1

UBGOG601BK UBGOG701BK UBGOG901BK



Built-in Gas Hob

Installation

36

Let's get started...



Getting started...

07

Before you start
Safety

08
09

In more detail...

14

Product functions
Operation
Care and maintenance
Troubleshooting
Recycling and disposal
Technical and legal information

15
18
20
22
22
23

Appendix

Installation

34



Getting Started...

**Before you start
Safety**

08

09

Before you start

- To avoid the risks that are always present when you use an electrical appliance it is important that this appliance is installed correctly and that you read the safety instructions carefully to avoid misuse and hazards. please keep this instruction booklet for future reference and pass it on to any future owners. after unpacking the appliance please check that it is not damaged. If in doubt, do not use the appliance but contact Customer Services on 0344 800 1128 (UK), 014475261 (Ireland)
- Check the package and make sure you have all of the parts listed.
- Decide on the appropriate location for your product.
- If this product contains glass please take care when fitting or handling to prevent personal injury or damage to the product.
- The specifications plate is available on this appliance. This plate displays all the necessary identification information for ordering replacement parts.
- If you sell the appliance, give it away, or leave it behind when you move house, make sure you also pass on this manual so that the new owner can become familiar with the appliance and its safety warnings.

Tools required

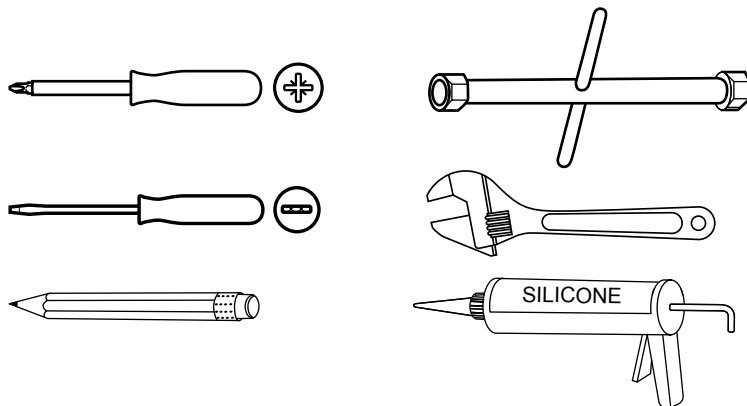

These instructions are for your safety. Please read through them thoroughly prior to installation and retain them for future reference.

WARNING: The connection of the hob to the gas network or gas cylinder must be made by means of a rigid copper or steel pipe with fittings complying with local regulations supplied.

THIS OPERATION MUST BE MADE BY A QUALIFIED GAS INSTALLER.

- This appliance complies with all current European safety legislation, however the Manufacturer must emphasise that this compliance does not prevent the surfaces of the appliance from heating up during use and remaining hot during its operation.
- Accessible parts may become hot during use. Young children should be kept away.
- Care should be taken to avoid touching the appliance when it is hot.
- The Manufacturer highly recommends that this appliance be kept out of the reach of babies and small children.
- This appliance can be used by children aged from 8 years and above and persons with reduced physical, sensory or mental capabilities or lack of experience and knowledge if they have been given supervision or instruction concerning use of the appliance in a safe way and understand the hazards involved.
- Children shall not play with the appliance.
- Cleaning and user maintenance shall not be made by children unless they are older than 8 years and supervised.
- Keep the appliance and its cord out of reach of children less than 8 years.

- Means for isolating the appliance must be incorporated in the fixed wiring in accordance with the current wiring regulations. An omnipolar circuit breaker having a contact separation of at least 3 mm in all poles should be connected in the fixed wiring.
- If the supply cord is damaged, it must be replaced by the manufacturer, its service agent or similarly qualified persons in order to avoid a hazard.
- Make sure that the power cord is not caught under or in the appliance and avoid damage to the power cable.
- Do not allow the electric cables to touch the hot parts of the appliance.
- Do not install the appliance outdoors, in any damp place or in an area which may be prone to water leaks such as under or near a sink unit. In the event of a water leak allow the machine to dry naturally.
- Please dispose of the packing material carefully.
- Do not use flammable sprays in close vicinity to the appliance.
- We also recommend that great care be taken during use and cleaning. Read the cleaning and maintenance sections for this appliance carefully.
- A steam cleaner is not to be used.
- The appliance is not intended to be operated by means of external timer or separated remote-control system.

- The appliance is for domestic use only.
- When a cooking zone has been on for a long time, the surface remains hot for some time afterwards so do not touch the metal surface.
- Do not store detergents or flammable materials beneath the hob.
- Do not leave hot oils or fats unattended as they may catch light.
- The Manufacturer declines all liability for personal or material damage as a result of misuse or incorrect installation of this appliance.

WARNING! Unattended cooking on a hob with fat or oil can be dangerous and may result in fire.

- Never try to extinguish a fire with water, but switch off the appliance and then cover the flame with a lid or a fire blanket.

WARNING! Risk of fire! Do not store items on the cooking surfaces.

- Prior to installation, ensure that the local distribution conditions (nature of the gas and gas pressure) and the adjustment of the appliance are compatible.
- The adjustment conditions for this appliance are stated on the label (or data plate).
- This appliance is not connected to a combustion products evacuation device.
- It shall be installed and connected in accordance with current installation regulations. Particular attention shall be given to the relevant requirements regarding ventilation.

CAUTION: This appliance is for cooking purposes only. It must not be used for other purposes, for example room heating.

- Don't put cooking vessels on the hotplate that overlap its edges.

CAUTION: The use of a gas cooking appliance results in the production of heat, moisture and products of combustion in the room in which it is installed.

- Ensure that the kitchen is well ventilated especially when the appliance is in use: keep natural ventilation holes open or install a mechanical ventilation device (mechanical extractor hood).
- Always use flat-bottomed cookware during cooking.
- Never use cookware with a diameter larger than the diameter of the cooking zone.
- This appliance shall be installed in accordance with the regulations in force and only used in a well ventilated space.

- Read the instructions before installing or using this appliance.

CAUTION: The use of a hob guard is not permitted with this appliance. Do not attempt to fit or use a hob guard as this can cause accidents.

- The minimum distance between this separation and the underneath of the worktop shall be stated and this minimum distance declared shall not exceed 150 mm.

CAUTION:

This hob has a glass cooking surface. In the event of any breakage to the glass:

- Stop use of the appliance immediately.
- Switch off all gas burners.
- Turn off the gas hob at the mains power supply.
- Do not touch the glass surface.

In more detail...



Product functions	15
Operation	18
Care and maintenance	20
Troubleshooting	22
Recycling and disposal	22
Technical and legal information	23

UBGOG601BK

Product functions

- 4 x Burners: Four zones of cooking.
- Flame safety device (FSD): Stops the gas supply to the gas hob when the flame goes out.
- auto - ignition
- LPG conversion kit supplied.

Control elements

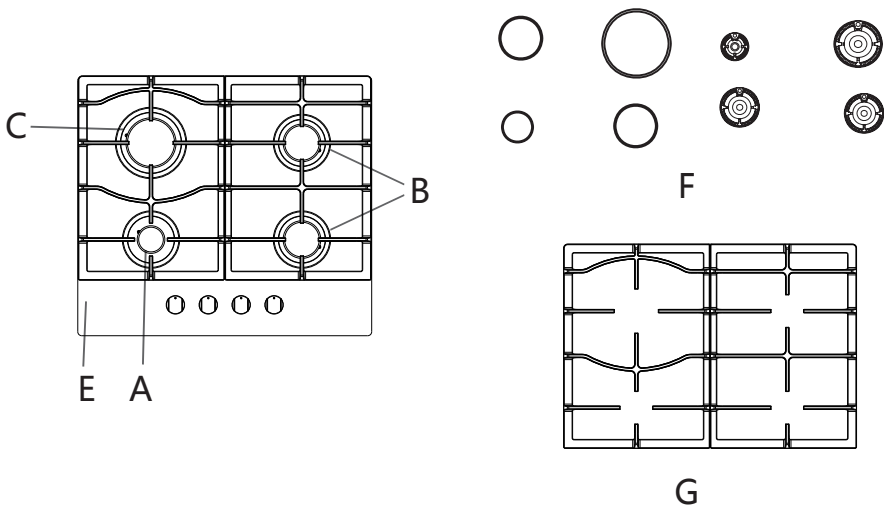

Reference	Description	Qty	Reference	Description	Qty
A	Auxiliary burner	1	E	Panel	1
B	Semi-rapid burner	2	F	Burner Cap	4
C	Large burner	1	G	Pan Support	2

Caution: This diagram may be slightly different from the layout of the appliance.

In more detail...

UBGOG701BK

Product functions

- 5 x Burners: Five zones of cooking.
- Flame safety device (FSD): Stops the gas supply to the gas hob when the flame goes out.
- auto - ignition
- LPG conversion kit supplied.

Control elements

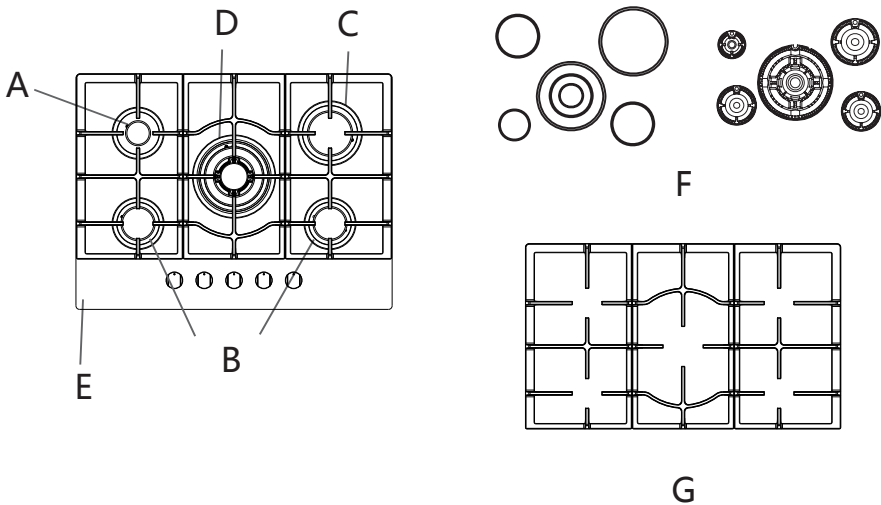

Reference	Description	Qty	Reference	Description	Qty
A	Auxiliary burner	1	E	Panel	1
B	Semi-rapid burner	2	F	Burner Cap	5
C	Large burner	1	G	Pan Support	3
D	Wok burner	1			

Caution: This diagram may be slightly different from the layout of the appliance.

UBGOG901BK

Product functions

- 5 x Burners: Five zones of cooking.
- Flame safety device (FSD): Stops the gas supply to the gas hob when the flame goes out.
- auto - ignition
- LPG conversion kit supplied.

Control elements

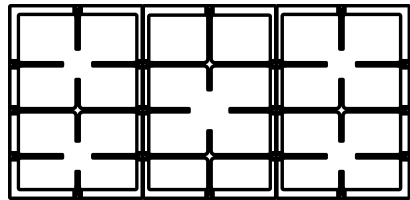
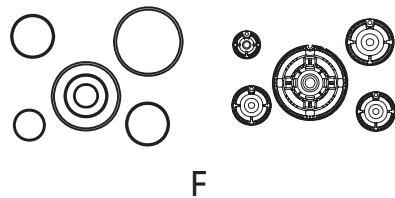
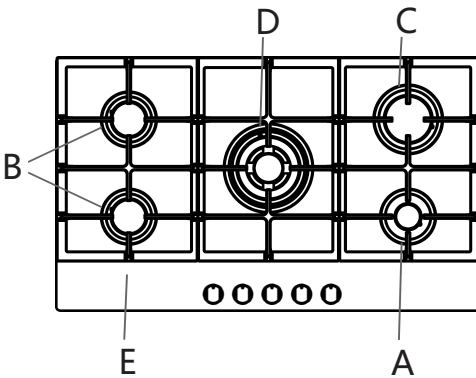

G

Reference	Description	Qty	Reference	Description	Qty
A	Auxiliary burner	1	E	Panel	1
B	Semi-rapid burner	2	F	Burner Cap	5
C	Large burner	1	G	Pan Support	3
D	Wok burner	1			

Caution: This diagram may be slightly different from the layout of the appliance.

In more detail...

Operation

UBGOG601BK



UBGOG701BK, UBGOG901BK

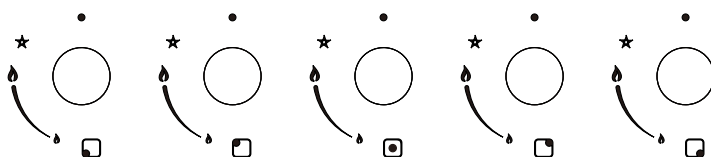

Use of the burners



Caution

- If there is no electric current you can light the burners with piezo electric spark gas ignitor.
- The burners can only be lit with safety thermocouples when the knob is on MAXIMUM.

On the control panel to the left of every knob there is a diagram to indicate the burner to which the knob in question refers. The burners can be switched on in several ways, according to the type of appliance and its individual features.

- Automatic electric "ON" switch for burners with safety device (thermocouples)
 - Turn the knob corresponding to the selected burner in a counter clockwise direction so that the knob is at MAXIMUM.
 - Once the burner is lit, keep the knob pressed in for about 10 seconds in order to allow the flame to heat up the thermocouple. If the burner goes out when the knob is let go, repeat the operation.

NOTE:

- > The use of a gas cooking appliance produces heat and humidity in the place where it is installed.
- > Therefore, you need to ensure the place is well ventilated, keeping the natural ventilation openings clear and using a mechanical ventilation device/ flue or electric fan.
- > Intensive or prolonged use of the appliance may require additional ventilation, such as opening a nearby window or increased ventilation efficiency obtained by increasing the power of the mechanical ventilators, where applicable.

Advice for the best use of the burner:

- > When boiling point is reached, turn the knob to MINIMUM.
- > Always use pans with a lid .

Burner	Minimum Diameter	Maximum Diameter
Wok	240mm	280mm
Large (rapid)	180mm	240mm
Medium (semi-rapid)	140mm	180mm
Small (auxiliary)	120mm	140mm

WARNING

If you use a saucepan that is smaller than the recommended diameter the flame will spread beyond the bottom of the vessel, causing the handle to overheat.

Never leave empty pot or pans over a lit burner.

Do not use tools for grill cooking on gas on glass hobs.

Appliance cleanliness



Warning

Always switch off the electricity supply before performing maintenance work. In the event of a fault, contact customer services.

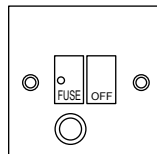

Caution

- Use soapy water and a cloth for cleaning. Never use abrasive powders.
- Avoid banging pots and pans down on the hob.
- Do not leave any empty pan on the heating zone.

- > The appliance should be cleaned after use.
- > Wipe the inner and outer surface of the appliance and its accessories with wet cloth.
- > Any liquid overflowing from the pan must always be removed with a cloth.
- > The surface of the hob may be easily cleaned as follows.

Cleaning the hob panel.

Regularly wipe over the hob top with a soft cloth well rung out in warm water to which a little washing up liquid has been added. Avoid use of the following:

- 1) Household detergent and bleaches.
- 2) Soap impregnated scouring pads.
- 3) Steel wool.
- 4) Bath/sink stain removers.

Cleaning the pan supports.

If washing them by hand, take care when drying them as the enameling and drying process occasionally leaves rough edges. If necessary remove stubborn stains using a paste cleaner.

Cleaning the burners.

The burner caps and crowns can be removed for cleaning. Wash the burner caps and crowns using hot soapy water and remove marks using a mild paste cleaner.

A well moistened soap impregnated steel wool pad can be used with caution if the marks are particularly difficult to remove. After cleaning make sure to dry using a soft cloth.

Note: It is very important to keep the thermocouples and the ignition candles in a clean condition to prevent problems lighting and maintaining a flame on the burners.

Replacement of parts

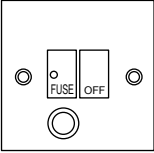

Warning

Always switch off the electricity supply before performing maintenance work. In the event of a fault, contact customer services.

Troubleshooting

The following circumstances may not be a problem. Do not contact the customer services until the problem has been confirmed.

If your appliance is still not functioning properly after making the above checks, please contact customer services.

1. Check that the mains supply has not been switched off.
2. Check that the fuse in the spur has not blown.
3. Ensure that the burner components are not excessively soiled as this can lead to ignition problems.

Do not take the appliance apart yourself, as you may damage the hob.

Before calling After Sales Service, please do the following:

1. Check that the appliance is correctly connected.
2. Read the failure text above. If you are still unable to solve the problem, switch off the appliance, do not try to take it apart and call customer services.

Recycling and disposal

Environmental protection

Waste electrical products should not be disposed of with household waste. Please recycle where facilities exist. Check with your Local Authority or retailer for recycling advice.



The symbol on the product or its packaging indicates that this product cannot be treated as normal household waste. This product must be handed over to an electric and electronic equipment collection point for recycling.

On ensuring that this product is disposed of correctly, you will help to avoid possible negative consequences for the environment and public health, which could occur if this product is not handled correctly. To receive more detailed information about recycling this product, contact your local government, domestic waste disposal services or the outlet where the product was bought.

Technical data

Power Supply	V/Hz	220-240 Vac 50/60Hz
Gas Pressure	mbar	G20-20mbar G30-28~30mbar
External Dimensions	HxDxW mm	55x520x590

	NG(G20 20mbar)		LPG(G30 28-30mbar)	
	Injector Dia. (mm) and kW		Injector Dia. (mm) and kW	
Gas Category	Dia	kW	Dia	kW
Rapid Burner	1.24	3.0	0.84	3.0
Semi rapid burner	0.98	1.75	0.69	1.75
Auxiliary burner	0.74	1.0	0.51	1.0

Energy efficiency

Product information according to EU 66/2014

Model Identification		UBGOG601BK
Type of hob		Built-in hob
Number of gas burners		4
Energy efficiency per gas burner (EE gas burner)	Auxiliary	Not Applicable
	Rapid	56.48%
	WOK	-
	Semi-Rapid	57.05% x 2
Energy efficiency for the gas hob (EE gas burner)		56.86%

EN 30-2-1: Domestic cooking appliances burning gas - Part 2-1: Rational use of energy - General

Technical data

Power Supply	V/Hz	220-240 Vac 50/60Hz
Gas Pressure	mbar	G20-20mbar G30-28~30mbar
External Dimensions	HxDxW mm	55x520x700

	NG(G20 20mbar)		LPG(G30 28-30mbar)	
	Injector Dia. (mm) and kW		Injector Dia. (mm) and kW	
Gas Category	Dia	kW	Dia	kW
Wok Burner	1.27	3.5	0.94	3.5
Rapid Burner	1.24	3.0	0.84	3.0
Semi rapid burner	0.98	1.75	0.69	1.75
Auxiliary burner	0.74	1.0	0.51	1.0

Energy efficiency

Product information according to EU 66/2014

Model Identification		UBGOG701BK
Type of hob		Built-in hob
Number of gas burners		5
Energy efficiency per gas burner (EE gas burner)	Auxiliary	Not Applicable
	Rapid	56.48%
	WOK	55.02%
	Semi-Rapid	57.05% x 2
Energy efficiency for the gas hob (EE gas burner)		56.4%

EN 30-2-1: Domestic cooking appliances burning gas - Part 2-1: Rational use of energy - General

Technical data

Power Supply	V/Hz	220-240 Vac 50/60Hz
Gas Pressure	mbar	G20-20mbar G30-28~30mbar
External Dimensions	HxDxW mm	55x520x874

	NG(G20 20mbar)		LPG(G30 28-30mbar)	
	Injector Dia. (mm) and kW		Injector Dia. (mm) and kW	
Gas Category	Dia	kW	Dia	kW
Wok Burner	1.27	3.5	0.94	3.5
Rapid Burner	1.24	3.0	0.84	3.0
Semi rapid burner	0.98	1.75	0.69	1.75
Auxiliary burner	0.74	1.0	0.51	1.0

Energy efficiency

Product information according to EU 66/2014

Model Identification		UBGOG901BK
Type of hob		Built-in hob
Number of gas burners		5
Energy efficiency per gas burner (EE gas burner)	Auxiliary	Not Applicable
	Rapid	56.48%
	WOK	55.02%
	Semi-Rapid	57.05% x 2
Energy efficiency for the gas hob (EE gas burner)		56.4%

EN 30-2-1: Domestic cooking appliances burning gas - Part 2-1: Rational use of energy - General

UBGOG601BK

Overall Dimensions:

Width: 590mm Depth: 520mm

Cut-out Dimensions

Width: 555mm Depth: 475mm

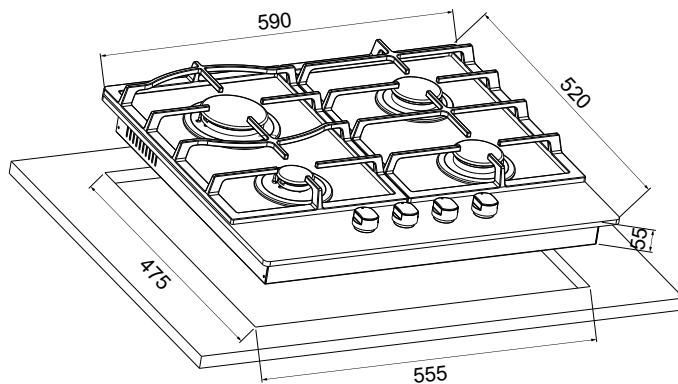
**UBGOG701BK**

Overall Dimensions:

Width: 700mm Depth: 520mm

Cut-out Dimensions

Width: 555mm Depth: 475mm

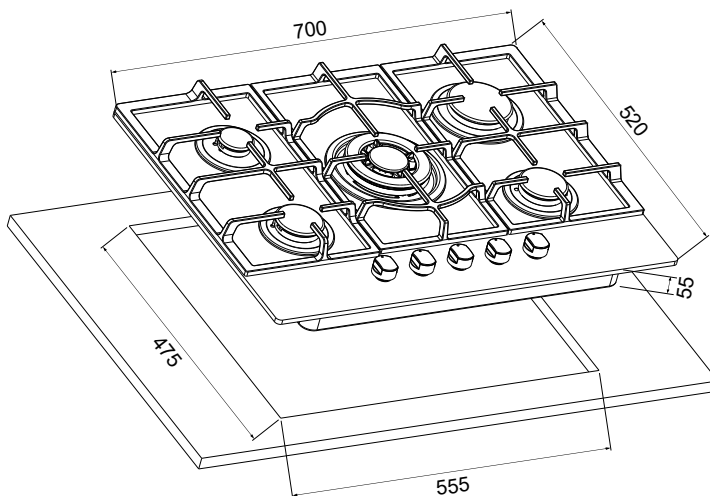

UBGOG901BK

Overall Dimensions:

Width: 874mm Depth: 520mm

Cut-out Dimensions

Width: 828mm Depth: 478mm

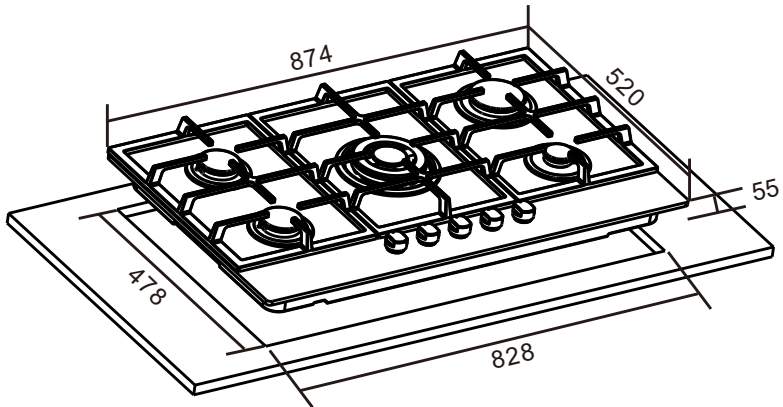

In more detail...

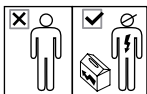

All installation work must be carried out by a competent person or qualified electrician. Before connecting the mains supply ensure that the mains voltage corresponds to the voltage on the rating plate inside the cooker hood.

Warning: THIS APPLIANCE MUST BE EARTHED.

Mains Supply could be connected to the Mains Voltage by Direct Connection

DOUBLE POLE SWITCHED
FUSED SPUR OUTLET

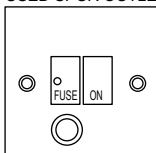

USE A 3AMP FUSE

Direct Connection

If the appliance is being connected directly to the mains an omnipolar circuit-breaker must be installed with a minimum opening of 3mm between contacts.

If the cable is damaged or to be replaced, the operation must be carried out by a qualified electrician with dedicated tools to avoid any accidents.

The installer must ensure that the correct electrical connection has been made and that it complies with wiring diagram.

The cable must not be bent or compressed.

The cable must be checked regularly and replaced by authorized technicians only.

Electrical Requirements

Any permanent electrical installation must comply with the latest I.E.E. Regulations and local electricity company regulations. For your own safety a qualified electrician or contractor who is on the roll of the National Inspection Council for Electrical Installation Contracting (NICEIC) should undertake the electrical installation.

Electrical Connection

Before connecting the mains supply ensure that the mains voltage corresponds to the voltage on the rating plate inside the appliance.

WARNING: THIS APPLIANCE MUST BE EARTHED

The appliance is supplied with a 3-core mains cable and must be connected to the electricity supply via a double pole switch having a 3mm minimum contact gap on each connector.

For UK only
A Switched Fused Connection Unit to BS 1363 Part 4 is recommended.

The fuse must be rated at 3 Amps.

The wires in the mains lead are coloured in accordance with the following code:

Brown = L - Live

Blue = N - Neutral

Green/Yellow = ⊕ - Earth

The connection point must be placed in a position adjacent to the appliance so as to be readily accessible for an engineer in the event of a breakdown.

Disconnect the appliance from the mains supply before carrying out any kind of maintenance or cleaning.

Installation Guidelines

Gas Supply Requirements (UK and ROI)

This installation must comply with the Gas Safety Regulations 1984.

The connection to the gas supply must comply with all current regulations in force.

We are not legally able to offer advice on the installation of gas appliances to non Gas Safe registered personnel.

Ventilation

All rooms require a window or equivalent (e.g. a door) which can be opened. Some rooms require a permanent vent or extractor in addition to a window (see below).

This unit must not be used in a room which is less than 5m³. The following table details the requirements based on the kitchen volume (L x W x H) in m³.

The above requirements also allow use of a gas oven and grill but if there are any other fuel burning appliances in the same room, consult the relevant British Standard (BS5440) or Gas Safe manual.

Room Volume (m ³)A	Air vent required (cm ³)
5	100
6 to 10	50
6 to 11	No permanent vent required if a door opens to the outside
11 or more	None required

The above requirements also allow use of a gas oven and grill but if there are any other fuel burning appliances in the same room, consult the relevant British Standard (BS440) or Gas Safe document.

What you should do if you smell gas?

Switch off the gas supply
Open doors and windows
Call Transco 0800 111 999

Gas connection



Caution

The gas connection must be installed in compliance with applicable regulations in the country of installation.

The preferred method of connection is by rigid copper pipe or by flexible hose, depending on local regulations. The hob is supplied with a G $\frac{1}{2}$ " elbow that can be used or discarded depending on approved method of connection and best engineering practice.

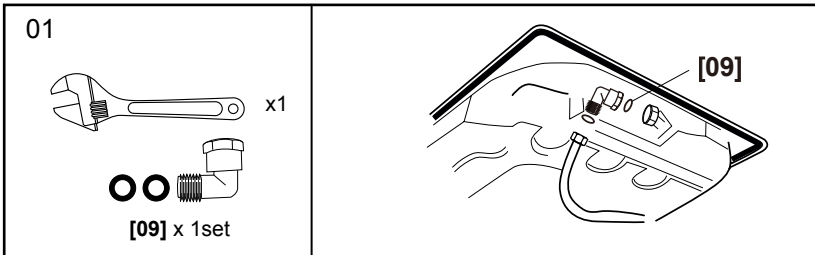

Changing the nozzles



Caution

The hob installation and burner changes must be carried out by a competent person, ie a Gas Safe registered fitter.

NOTE: The LPG nozzles are provided in a separate bag marked "LPG" and if they are changed and the natural gas jets retained then the label should be changed to "NATURAL".

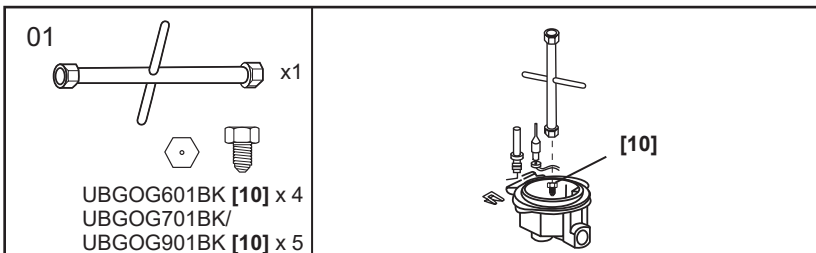

Lift up the burners and unscrew the nozzle using a dedicated tool and replace the nozzles with those designed for LPG gas supply .
(see table on page 19)

Note: When the injectors have been changed the gas technician should mark the appliance to show which injectors are being used.

Regulation of burners



Caution

The regulation described can only be carried out with burners that use methane gas and city gas (where available), whereas the screw must be fully tightened in a clockwise direction on burners using liquid gas.

02

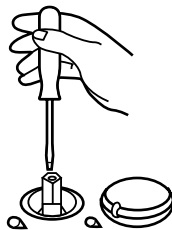

Regulation of the “MINIMUM” position on the burners.

To regulate the minimum position on the burners, follow the procedure below:

1. Turn on the burner and turn the knob to its MINIMUM position (small flame).
2. Remove the knob from the tap set for standard pressure. The knob is found on the bar of the tap itself.
3. Place the tap bar on the work top, use a small screwdriver that fits the (gold) screws located at the lower part of the tap and turn the fixing screw to the right or left until the flame of the burner is regulated in the most suitable manner to MINIMUM.
4. Make sure that the flame does not go out when changing the position quickly from MAXIMUM to MINIMUM position.

GAS CONNECTION



CAUTION

THE GAS CONNECTION MUST BE INSTALLED IN COMPLIANCE WITH APPLICABLE REGULATIONS IN THE COUNTRY OF INSTALLATION.

The preferred method of connection is by rigid copper pipe or by flexible hose, depending on local regulations. The hob is supplied with a G $\frac{1}{2}$ " elbow that can be used or discarded depending on approved method of connection and best engineering practice.

STANDARDS

UK: Gas safety (Installation and use) Regulations 1998

France: Bottled Gas NF D 36-125
Gas Network NF D 36-121

The Manufacturer has a policy of continuous product improvement, it reserves the right to adapt and carry out any modification considered necessary without prior warning.

Appendix...

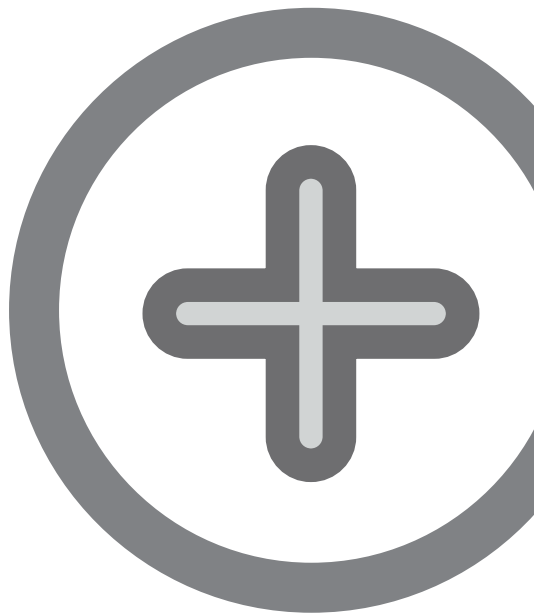

Clearance



Warning

Good ventilation is required around the appliance for easier dissipation of heat and low power consumption. Sufficient clearance is required around the appliance. The gap between the hob and any cupboard above it should be at least 750mm.

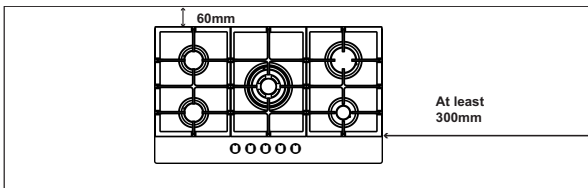
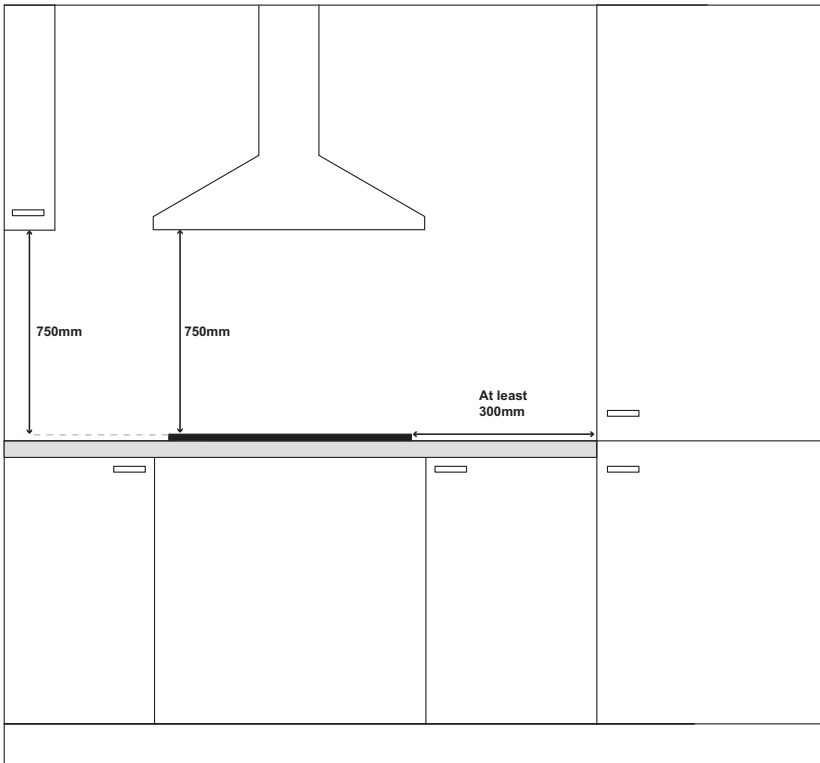

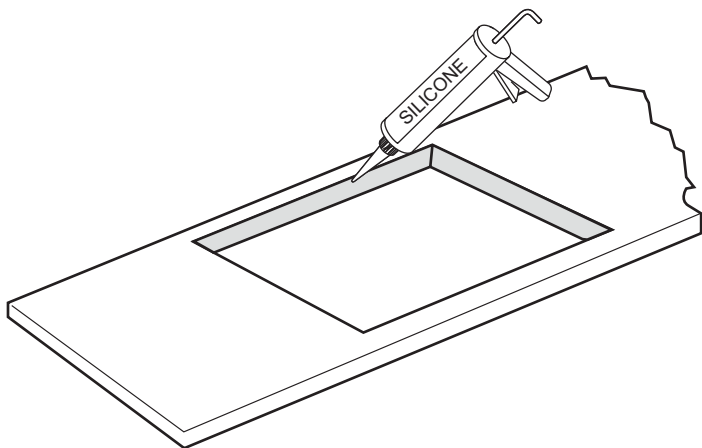

01

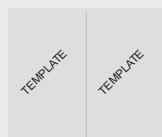

[12] x 1



Cut out worktop to the template dimensions with suitable equipment and seal the cut edge with appropriate sealant.

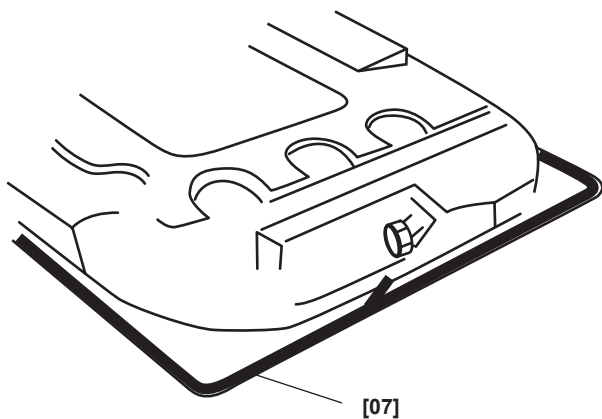

02



[07] x 1

Stretch out the supplied seal along the underside edge of the hob, ensuring the ends overlap.

03

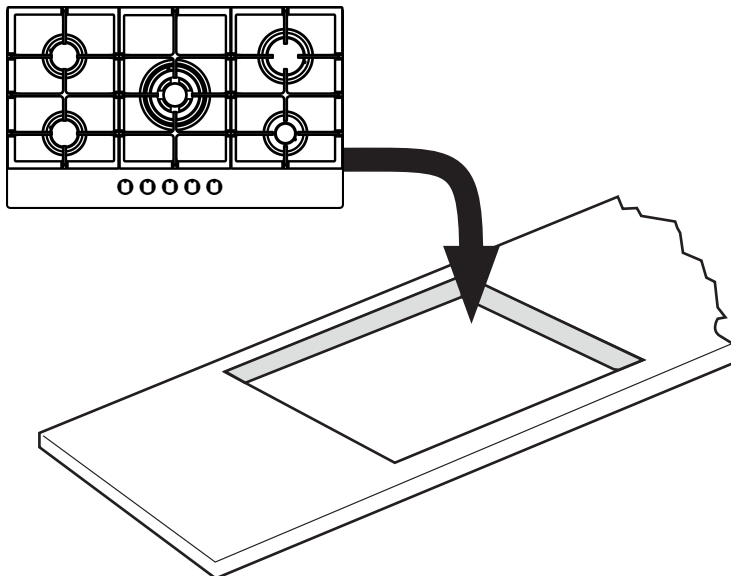

04



UBGOG601BK [08] x 3
UBGOG701BK/
UBGOG901BK [08] x 4



UBGOG601BK [11] x 3
UBGOG701BK/
UBGOG901BK [11] x 4

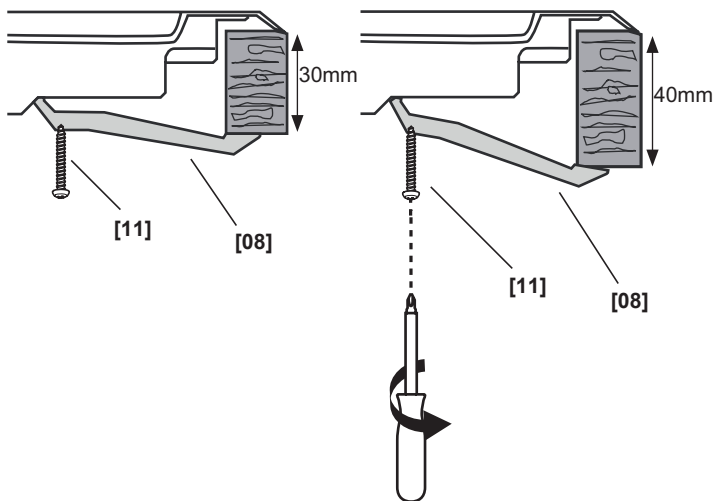

Note: The images above are a guide only.

Note: For electrical connection see Technical and legal information section

AAUK Ltd
Good Hope Close
Normanton Industrial Estate
Normanton
West Yorkshire
WF6 1TR



此页不印刷
This page will
not be printed

版本号：20231121 V1.3
材质：A5,70克双胶纸，单色印刷，骑马钉