

TFT DOUBLE OVEN
in stainless steel or black

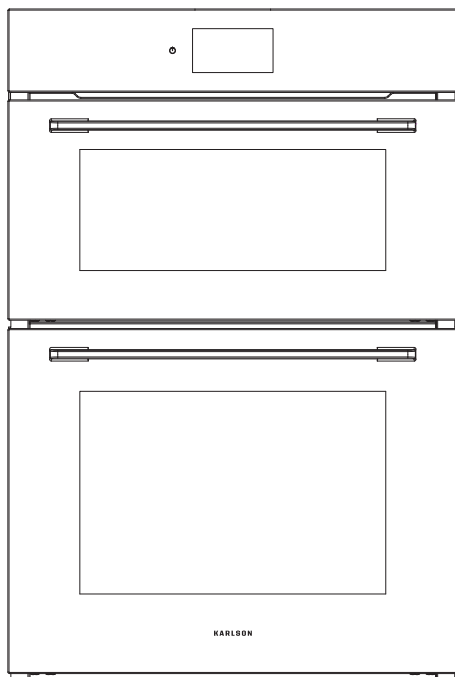







TFTDOVSS
TFTDOVBK

KARLSON

User Manual



	BEFORE USING YOUR APPLIANCE	03
	SAFETY	03
	ELECTRICAL INSTALLATION	06
	TECHNICAL DATA	07
	TROUBLESHOOTING	08
	GUARANTEE	09
	INSTALLATION	11
	USE	15
	CARE & MAINTENANCE	33
	SERVICE & SPARES	40



BEFORE USING YOUR APPLIANCE

These instructions are for your safety. Please read them thoroughly prior to installation and retain them for future reference.

WARNING: All installation work must be carried out by a suitably qualified person, strictly following local building regulations and these instructions.

- To avoid the risks that are always present when you use an electrical appliance it is important that this oven is installed correctly and that you read the safety instructions carefully to avoid misuse and hazards. After unpacking the oven please check that it is not damaged. If in doubt, do not use the appliance and contact Customer Services.
- This oven shall not be used for any purpose other than cooking. It is dangerous and inappropriate to use it for any other purpose (e.g. to heat the room it is in). The manufacturer declines all liability for personal or material damage as a result of misuse or incorrect installation of this appliance.
- Check the package and make sure you have all of the parts listed and decide upon the appropriate location for your product. If this product contains glass please take care with fitting or handling to prevent personal injury or damage to the product. The specification plate shown on this appliance displays all the necessary identification information for ordering replacement parts. If you sell the appliance, give it away, or leave it behind when you move house, please ensure that you pass on this manual so that the new owner can become familiar with the appliance and its safety warnings.

SAFETY

Do not use the oven handle on the front door to carry the oven or to remove it from its packaging.

This oven and its accessories become hot during operation. Avoid contact with the heating elements inside the oven and when grilling.

To prevent damages that may be caused by improper placement of the thermal circuit breaker, this device shall not be connected to external circuit devices such as timers or always-on or always-off circuits.

Do not open the oven door if the appliance has smoke coming out of it. Turn off the oven, unplug it or switch off the circuit breaker.

Flammable objects that are kept in the oven may ignite. Do not keep the flammable objects in the oven.

Always use oven gloves when you are taking hot food or utensils such as trays, etc. from the oven or the grill.

Ensure you remove all packaging material before starting to operate the oven.

continued overleaf



SAFETY (CONTINUED)

This oven can be used by children aged from 8 years and above and persons with reduced physical, sensory or mental capabilities or lack of experience and knowledge if they have been given supervision or instruction concerning use of the appliance in a safe way and understand the hazards involved. Children shall not play with the oven. Cleaning and user maintenance shall not be made by children without supervision.

- When you operate the oven for the first time, a smell caused by the insulation materials and heating elements may occur once. In such a case, operate the oven without putting any food inside it for 30 minutes at maximum temperature with the upper and lower heater (and 3D, if applicable) function turned on.
- Plastic containers that are not oven compatible may melt and damage the oven or may start a fire at high temperatures.
- Do not cover the bottom of the oven with aluminium foil.
- In case of failure or improper operation of the oven, switch off the mains power supply to the appliance.
- When the oven is not used ensure that the oven is in standby mode, with all functions switched off.
- Pay attention to alcoholic beverages used for cooking some dishes may evaporate at high temperatures and ignite on hot surfaces.
- Canning operation or heating may cause high pressures in enclosed containers, the containers may explode as a result of this pressure. Do not can food in closed containers or do not heat closed containers.
- When the door of the oven is open, do not place any heavy objects on the door or allow children to sit on it. This may cause tipping over of the appliance or damage to the door of the oven.
- To prevent steam condensation in front of the TFT Screen while you open the door at the time the cooking finished, keep door opening at least for 3 minutes after the end of cooking.



SAFETY (CONTINUED)

- Do not use a steam cleaner to clean the oven.
- Baking paper may come in contact with heating elements and catch fire. Do not randomly place cooking paper during pre-heating the oven. Always place a container or a cake tin on the baking paper.
- The appliance is not intended to be operated by means of an external timer or separate remote control system.
- If the supply cord is damaged, it must be replaced by the manufacturer, its service agent or similarly qualified persons in order to avoid a safety hazard.
- Please dispose of the packing material carefully. There is a fire risk if cleaning is not carried out in accordance with the instructions.
- Do not use the oven if it shows signs of damage or imperfection. Contact customer services for assistance.
- This oven has been designed for cooking in home kitchens only. Commercial or business use of any kind is not covered by a manufacturer's warranty.
- Do not use or leave the oven outdoors.
- Do not use the oven near water, on a wet ground or in the vicinity of a pool.



ELECTRICAL INSTALLATION

All installation must be carried out by a competent person or qualified electrician. Before connecting the mains supply ensure that the mains voltage corresponds to the voltage on the rating plate.

- The circuit supplying the oven must be protected by a 32A RCD.
- Place the oven so that the outlet or double pole switch used for power connection may be reached easily.
- Do not place the power cord in contact with hot surfaces and do not pinch it to the product cover.
- The temperature of the power cord shall not reach a temperature that is 50°C above the ambient temperature.
- Regularly check the power cord for damage. If the supply cord is damaged, it must be replaced with a new one with the same dimensions and plastic insulation and that may withstand the electrical current required by the oven.
- Test the heating elements for 3 minutes when the connection is complete.
- If the oven is to be connected directly to the mains, a double pole switch suitable for carrying the desired load as per the current legislation and with a clearance of 3mm between its contact points shall be installed between the oven and the mains. The Earth wire shall not be cut off by the double pole switch.



WARNING: This is a Class I appliance and MUST be earthed.

This appliance is supplied with a 3 core mains cable coloured as follows:

Brown = L or Live

Blue = N or Neutral

Green and Yellow = E or Earth 

To avoid the risks that are always present when you use an electrical appliance it is important that this appliance is installed correctly and that you read the safety instructions carefully to avoid misuse and hazards. Please keep this instruction booklet for future reference and pass it on to any future owners. After unpacking the appliance please check that it is not damaged. If in doubt, do not use the appliance but contact Customer Services.

The manufacturer declines all liability for damage caused to persons and objects due to incorrect or improper installation of the appliance. Any permanent electrical installation must comply with the latest wiring regulations applicable to your country and for your own safety a qualified electrician or contractor should undertake the electrical installation.

TECHNICAL DATA

Model identification	TFTDOVSS / TFTDOVBK
Functions	Upper 8 , Lower 15
Oven lamps	25W
Supply voltage	220-240V~ 50/60Hz
Rated Power	4540-5400W
Capacity	Upper 40L , Lower 61L
Product size W x D x H (mm)	594 x 563 x 888
Built in dimensions W x D x H (mm)	560 x 560 x 880
Type of oven	Double oven
Trademark	KARLSON
Energy Efficiency Index per cavity	95,0
Energy Efficiency Class(A+++ to D)	A
Energy consumption (electricity) required to heat a standardised load in a cavity of an electric heated oven during a cycle in conventional mode per cavity (electric final energy)	Upper 0.63 kWh/cycle Lower 0.66 kWh/cycle
Energy consumption required to heat a standardised load in a cavity of an electric heated oven during a cycle in fan-forced mode per cavity (electric final energy)	Upper - - - kWh/cycle Lower 0.69 kWh/cycle
Number of cavities	2
Heat source per cavity (electricity or gas)	Electricity

Weight and dimensions are approximate. Because we continually strive to improve our products we may change specifications and designs without prior notice.

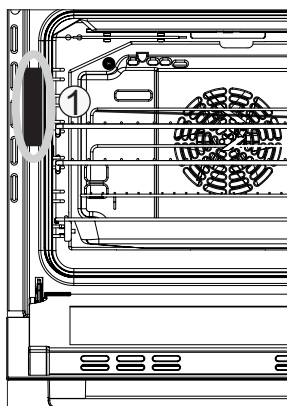

You may access the nameplate of the oven indicating technical specifications of the oven even after installing the oven in the kitchen. You will see the nameplate when you open the oven as shown in the diagram (1). Use the information provided on this nameplate to specify the model of your oven when ordering a spare part.



TROUBLESHOOTING

IMPORTANT: If the oven becomes responsive during an operational task, press the  key for 8 seconds to restart the oven.

If an abnormality occurs, the oven will enter the protective state automatically and display corresponding protective codes:

Error code	Possible cause	Solution
E01	Open circuit temperature sensor on lower cavity.	Replace temperature sensor probe on lower cavity.
E02	Short circuit temperature sensor on lower cavity.	Replace temperature sensor probe on lower cavity.
E03	Abnormality detected on power board.	Replace power board.
E04	Open circuit temperature sensor on upper cavity.	Replace temperature sensor probe on upper cavity.
E05	Short circuit temperature sensor on upper cavity.	Replace temperature sensor probe on upper cavity.

Problem	Cause/Solution
The oven does not warm up.	Check whether one of the following actions solves the problem: 1. The oven may not be turned on. Turn on the oven (turning the screen on). 2. A fuse may have blown in your house or a circuit breaker may have tripped. Change the fuses or reset the circuit. If this happens several times, call Customer Services for technical support.
Cannot change the temperature set.	Ensure that the controls are working correctly. (See instructions in Use section).
The oven light does not switch on.	It may be necessary to change it, but first of all check that it is correctly fitted and making contact correctly. Remember that bulbs are not covered by the warranty. Call Customer Services.
The grill does not heat up correctly.	Grill temperature may be set too low. Set the temperature control to a higher temperature.

The above is a table of common failures.

Please do not disassemble the unit by yourself to avoid any dangers and damages to the oven and please contact the service department.



DECLARATION OF CONFORMITY

(EU) Declaration of Conformity

Name and address of the manufacturer or his authorised representative:

AAUK Ltd

Unit 3 Normandy Landings

Pope Street, Castleford

West Yorkshire

WF6 2AG

This declaration of conformity is issued under the sole responsibility of the manufacturer.

Object of the declaration:

- **Product: TFT Multifunction Oven**
- **Model: TFTDOVSS**
- **Model: TFTDOVBK**

The object of the declaration described above is in conformity with the relevant Union harmonisation legislation :

2014/30/EU Electromagnetic compatibility

2014/35/EU Low Voltage Directive

RoHS Directive 2011 / 65 / EU

REACH Directive EC No 1907 / 2006

References to the relevant harmonised standards used or references to the other technical specifications in relation to which conformity is declared:

EN 60335-1:2012+A11+A13+A1+A2+A14+A2

EN 60335-2-6: 2015+A1+A11

EN 62233:2008

EN 55014-1:2017+A11

EN 55014-2:2015

EN IEC 61000-3-11:2019

EN 61000-3-12:2011

(UK) Declaration of Conformity

Name and address of the manufacturer or his authorised representative:

AAUK Ltd

Unit 3 Normandy Landings

Pope Street, Castleford

West Yorkshire

WF6 2AG

This declaration of conformity is issued under the sole responsibility of the manufacturer.

Object of the declaration:

- **Product: TFT Multifunction Oven**
- **Model: TFTDOVSS**
- **Model: TFTDOVBK**

References to the relevant harmonised standards used or references to the other technical specifications in relation to which conformity is declared:

BS EN 60335-1 : 2012 + A11 + A13 + A1 + A2 + A14

BS EN 60335-2-6 : 2015 + A1 + A11

BS EN 62233 : 2008

BS EN 55014-1:2017+A11

BS EN 55014-2:2015

BS EN IEC61000-3-11:2019

BS EN 61000-3-12:2011



RECYCLING & DISPOSAL



DISPOSAL: Do not dispose this product as unsorted municipal waste. Collection of such waste separately for special treatment is necessary.

This appliance is labelled in compliance with European directive 2011/65/EU for Waste Electrical and Electronic Equipment (WEEE). By ensuring that this appliance is disposed of correctly, you will help prevent any possible damage to the environment and to human health, which might otherwise be caused if it were disposed of in the wrong way.

The symbol on the product indicates that it may not be treated as normal household waste. It should be taken to a collection point for the recycling of electrical and electronic goods.

This appliance requires specialist waste disposal. For further information regarding the treatment, recover and recycling of this product please contact your local council, your household waste disposal service, or the shop where you purchased it.

For more detailed information about treatment, recovery and recycling of this product, please contact your local city office, your household waste disposal service or the shop where you purchased the product.

Packaging



All packaging materials are recyclable. Dispose of packaging material in recycling containers to help protection of the environment.



WHAT'S REQUIRED FOR INSTALLATION



WHAT'S IN THE BOX

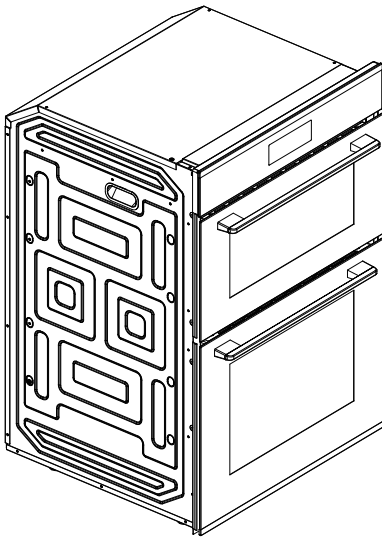

[01] x 1

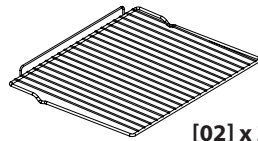

[02] x 2
WIRE SHELVES

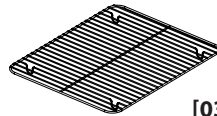

[03] x 1
TRIVET

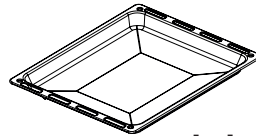

[04] x 2
GRILL PAN



[05] x 4
SCREWS



BEFORE YOU INSTALL THE OVEN

01

Make sure that . . .

- Take off and remove all packaging materials and adhesive tapes from the cooking compartment and the door before operating the oven.
- Do not install the oven behind a decoration or a furniture cover. This would pose a risk due to overheating.
- Cutting operations on the furniture shall be performed before the installation of the oven. Remove any burrs. They may have an adverse effect on the functioning of electrical units.
- For safety reasons, direct contact of the oven with electrical parts shall be prevented when the installation is complete.
- Parts that provide insulation and protection shall be installed so that they cannot be removed by using any tool.
- Rear compartment of the cabinet in the kitchen unit shall be removed to ensure a more efficient air circulation.
- We recommended you allow a minimum clearance of 20mm from the rear of the kitchen unit to where the oven is installed.
- We do not recommend installation of the oven near a refrigerator or deep freezer. Otherwise, the performance of such appliances shall be affected adversely due to the dissipated heat.
- Be careful not to damage the installation holes by applying too much pressure on the screws during installation.
- When a built-in hob is installed on the counter above the oven, the electrical cables of the oven and the hob should be separated for safety purposes and to facilitate the removal of the oven and hob when necessary.



02 CHECK YOUR DIMENSIONS FOR INSTALLATION

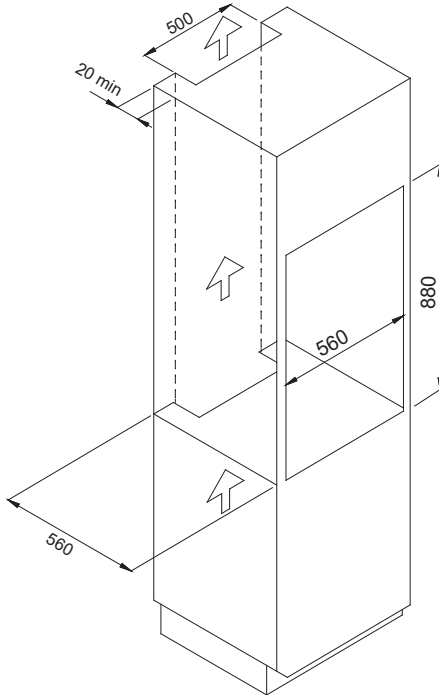

Unit: mm

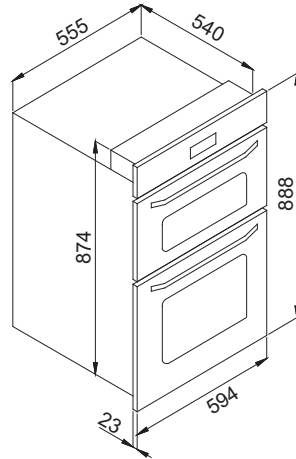

- The oven may be installed in a tall cabinet.

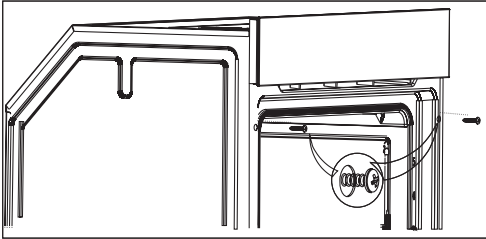

The fact that the oven becomes lighter when the door and the accessories are removed facilitates in the placement of the oven inside the cabinet.

- Place the oven by centering it inside the built-in appliance cabinet.
- Screw the oven securely.

WARNING: Installing the screw without drilling a hole suitable for the screw diameter in the furniture may cause damage to your furniture.



USING YOUR OVEN

Before using your Oven

- Read this guide, taking special note of the Safety section.
- Remove any protective film that may still be on your oven.

Before first use

When using the oven for the first time:

IMPORTANT: Wash the components such as tray or grill with cleaning agents before operating the oven for the first time.

- Ensure that no packaging such as polystyrene etc are left inside the cooking compartment and remove adhesive tapes on or inside the oven.
- Set the temperature to maximum level.
- Set the function to convection mode.
- Heat the oven while it is empty for 30 minutes to remove the smell of a new appliance.
- Open the windows to ventilate your room.
- At this time, a smell and smoke caused by the insulation materials and heating elements may occur once. In such a case, wait until the smell and smoke wears off before putting any food inside the oven.
- Clean the inside of the oven using a soft cloth slightly dampened with soapy water.

Always grab the handle from its centre to open the oven door.

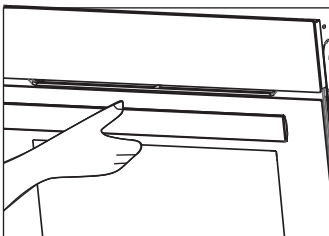

Energy Efficiency

- Opening the oven door frequently during cooking allows the cold air to enter inside the oven each time, thus it causes loss of energy. Therefore, do not open the oven door more than required.
- Try to cook multiple dishes simultaneously in the oven. Take the meal cooked with a lower temperature out first, and use less energy without changing the oven temperature.
- Excess heat remaining after cooking a meal shall be used for the next meal, too. This shall save power.



BEFORE YOU START

WARNING: Read the instructions before using the appliance.

The oven has two capacity spaces, a 40 and 61 Litre and offers users the option of cooking on two differently spaces at the same time or cooking larger quantities which would not necessarily be possible in a traditional oven.

- The first time you use your appliance , heat the empty oven with its door closed at its maximum temperature for at least half an hour . Make sure that the room is well ventilated before switching the oven off and opening the oven door .The appliance may emit a slightly unpleasant odour caused by protective substances used during the manufacturing process burning away.
- Never put objects directly on the bottom of the oven ; this will prevent the enamel coating from being damaged.
- Always place cookware on the rack (s) provided.
- We suggest not opening the door when cooking foodstuffs which require leavening , so as to not compromise cooking results.

FEATURES

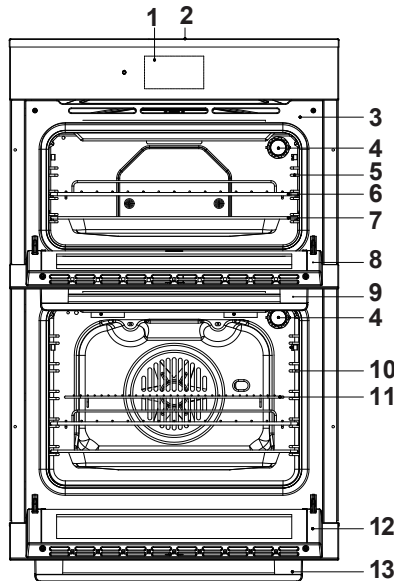

- | | | |
|----------------------------|--------------------------------|-------------------------|
| 1. Display | 6. Wire Shelves | 11. Trivet |
| 2. Control Panel Glass | 7. Grill Pan | 12. Door (Bottom oven) |
| 3. Door frame | 8. Door(Top oven) | 13. Handle(Bottom oven) |
| 4. Lamps | 9. Handle(Top oven) | |
| 5. Lateral grids(Top oven) | 10. Lateral grids(Bottom oven) | |



OVEN ACCESSORIES

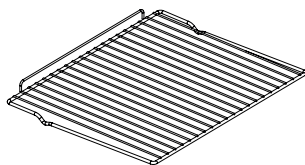

Wire Shelf x 2

Full width wire shelves remain in a horizontal position even when they are pulled out of the oven due to their special structure. There is risk of sliding the plate and spilling the food.

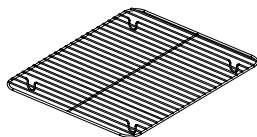

Trivet x 1

For cakes and cookies made in the tray.

Do not use the shallow tray for cooking as it shall cause smell and oils may splash out of the tray and soil the oven.

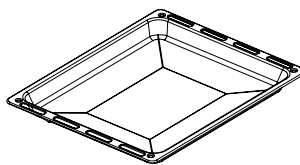

Grill Pan x 2

Universal pan for cakes, soft cakes, frozen food and meat dishes with big pieces of meat.

It may be used as a grease collecting plate when you grill directly on the wire grill.



FUNCTIONS & SETTINGS

01 Control panel

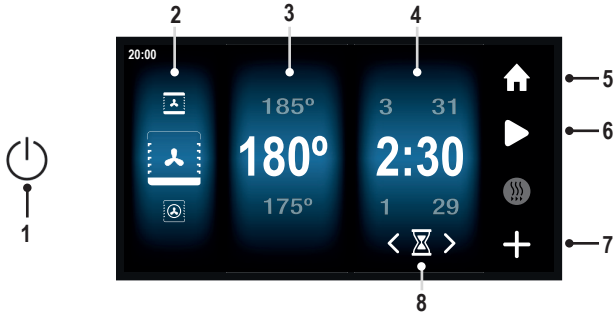

- 1. Power On/Off
- 2. Functions Menu
- 3. Temperature
- 4. Timer
- 5. Home
- 6. Start
- 7. Advance for Countdown
- 8. Timer Mode

02 Functions Menu

Top oven (in scroll order)			
	conventional mode		Maxi-Grill
	Upper heater		Keep Warm Function
	Lower element mode		Low Temperature
	Grill		ECO mode
Bottom oven (in scroll order)			
	conventional mode		Fan-Assisted Circular element mode
	Upper heater		Fan-Assisted Lower element mode
	Lower element mode		Pizza Function
	Grill		Keep Warm Function
	Grill and Fan		Low Temperature
	Maxi-Grill		Defrost
	Fan-Assisted Grill		ECO mode
	Fan-Assisted Convection mode		



03 Using for the first time

When the oven is connected to the mains, it automatically turns on.

1. Set the date

Press the arrow  on the right-hand side of the screen.



2. Set the time

Press the arrow  on the right-hand side of the screen.

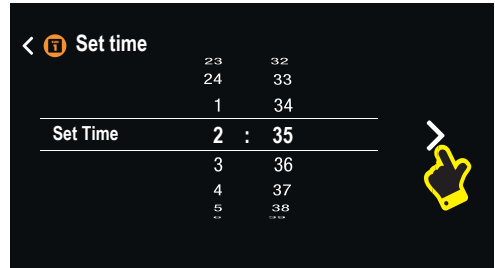

NOTE: Any values that are not defined by the user will be set to default.



04 Operation

ON/OFF KEY



Turning the Screen On

Press the power button 

Four main screens are displayed: Cooking, Settings, Recipes and Ecosteam Clean.

Turning the Screen Off

Press the power button  to turn it off at any point.

1. Under cooking conditions, press and hold the power button for 2 seconds to go to **Standby mode** (clock screen).
2. Under non-cooking conditions, press  once to go to **Standby mode** (clock screen).
3. Under clock screen, press  once to go to **Hibernation mode** (screen off).
4. Under any condition, press and hold  for 8 seconds and the system will restart.





START COOKING

Note:

- **The display** for upper and lower cavity condition. Off means function not activated. **The display** would show the actual working condition of the cavity.
- To enter the cooking functions menu, touch the **OFF** or **Oven Symbol**.
- Left side area for top oven and right side for bottom oven.
- Press **STOP** to end cooking for the top or bottom oven or press **BACK** to end all functions.

To start cooking

1. Set the function and the temperature
2. Press the **START** icon on the right-hand side of the screen.

Once cooking has started, the real temperature appears below the selected temperature in a red circle to show the heating process.

You can return to the main menu at any time by pressing **BACK** or **HOME** key.

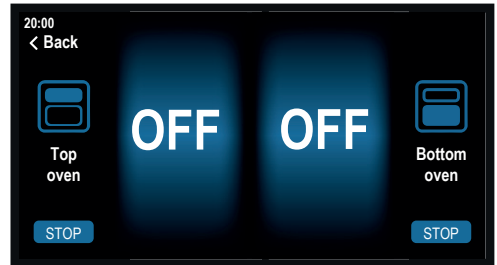

It would return to previous screen when there is no touching operation within 10 seconds.

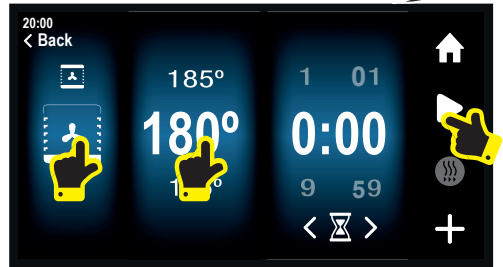



END OF COOKING OPTIONS

Alarm will be activated while cooking completed. And would be stopped after the screen is touched by end user.

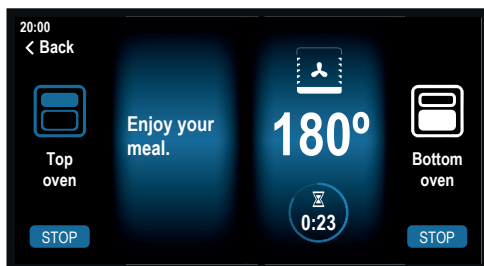

TIMER FUNCTION

Countdown



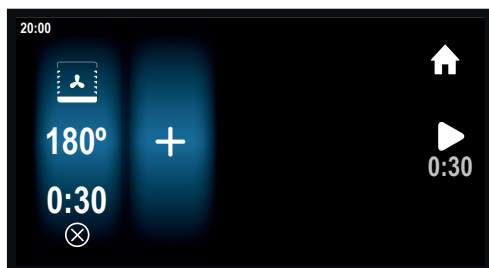
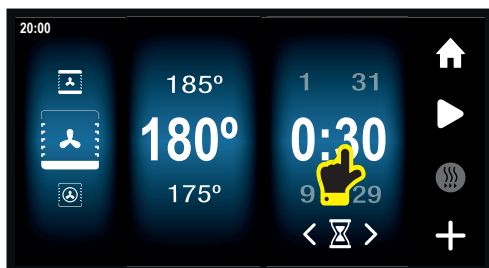

1. Scroll to select time (max. time 9 hours 59 mins).
2. Once oven reaches target temperature a short signal will sound and repeat 3 times. **Countdown** will start after 20 seconds.
3. When **Countdown** completes, the finish screen will appear and alarm will sound.
4. Only when **Countdown** mode is selected, before pressing play to start cooking, after rolled the time, **Advance Countdown** key would be activated and then phase function can be added as extra setting for different cooking procedures.







TIMER FUNCTION (CONTINUED)

Preset Start

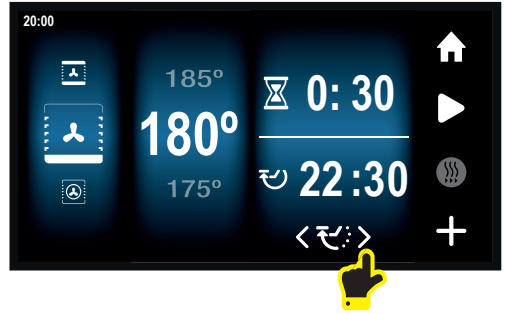
1. Press < or > to select **Preset Start**  icon.
2. Scroll to select time.
Example: screen shows setting to finish cooking at 22:30 and 30 min cooking time.
3. Whilst cooking, the lamp can be turned off manually by pressing  icon.
4. You can set an extra reminder alarm by pressing  icon.
5. Whilst cooking, to lock the screen press  icon. Once locked, press lock key again for 2 seconds to unlock the screen.



Preset Stop

1. Press < or > to select **Preset Stop**  icon.
2. Scroll to select the time to stop cooking (time needs to correspond with the clock set on the oven).
3. Once the oven reaches the **Preset Stop** time cooking will stop, the finish screen will appear and the alarm will sound.



RECIPES

Note: Recipes are only available on lower cavity.

Quick Access recipes

Various recipes are included with this oven. Cooking tables give quick access to programmed cooking. They are defined according to the most appropriate time and temperature. The indicated temperatures are reference values when cooking with liquids.

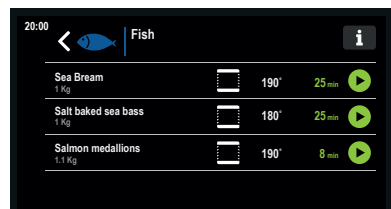
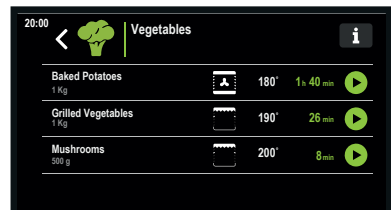
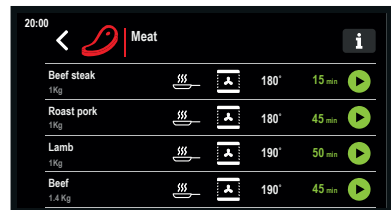
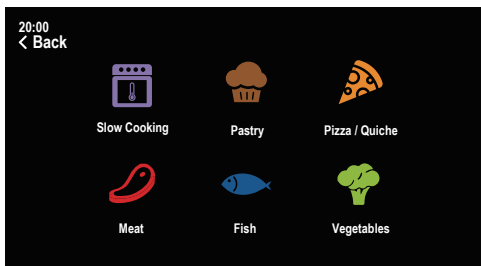
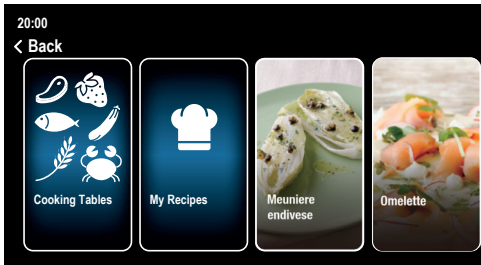



Use

RECIPES(CONTINUED)

To access all available recipes

1. Select the **Recipes** menu and choose the recipe you want.

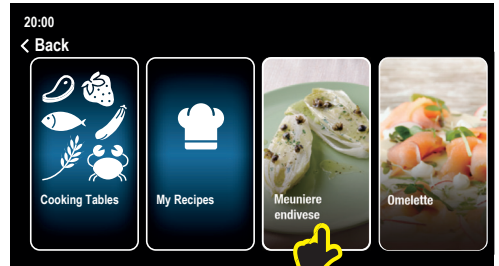

2. Press **Play**



< Back

DIFFICULTY : Low

COOKING TIME: 1 h 30min

TYPE: Sous Vide

NUMBER OF PEOPLE:4 servings

ALLERGENS:Milk(butter)

INTRODUCTION:
4 endives
200g butter(100g for the sauce and 100g for browning)
40g capers
1 lemon
200g sunflower oil
Salt and pepper

WHAT YOU NEED:
Induction hob with temperature control Plastic pouches

STEP1:
Rinse the endives and leave them in water for 20 minutes to remove the bitterness. Drain and dry them.

STEP2:
Rinse and dry the capers and fry them with plenty for hot oil for 1 minute.
Drain and dry them on paper towels.

STEP3:
Toast the butter until golden (it should take on a light brown colour and faint hazelnut aroma)

STEP4:
Place the halved endives in a bag or container with the cooled toasted butter, plus a pinch of salt and pepper.

STEP5:
Cook at 85 °C for 1 hour.

Cook Step5



CREATING AND SAVING RECIPES

To create a new recipe

1. Select the **My Recipes** menu.

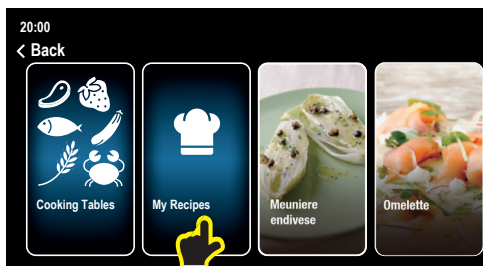

2. Press the '+' symbol that appears on the left.

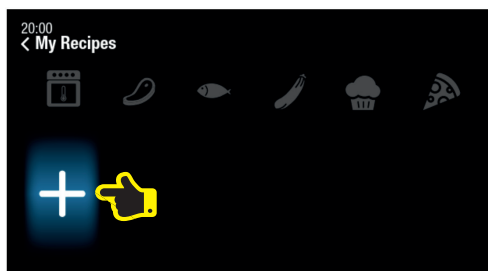

3. Filter icons are displayed in grey with a generic cook's hat icon.

New recipes can be saved using filter options of Slow Cooking, Pastry, Pizza/ Quiche, Meat, Fish, Vegetables.

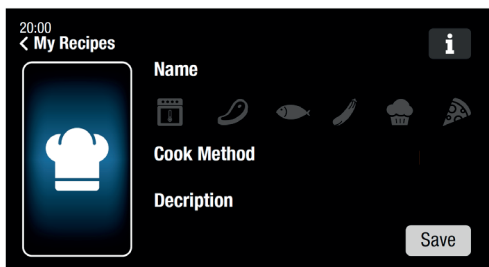



CREATING AND SAVING RECIPES (CONTINUED)

Note: When creating a new recipe ALL fields (Name, Temperature, Time and Description) must be completed in order to save the recipe.

4. Select required icon and **Save**
Icon is displayed in white and the main image on left of the screen changes to that icon.

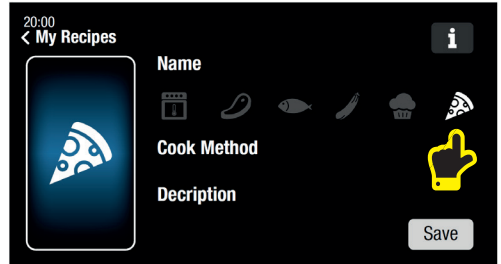

5. Give the recipe a name and **Save**
(The limit of char which user can enter to this slot is 30.)

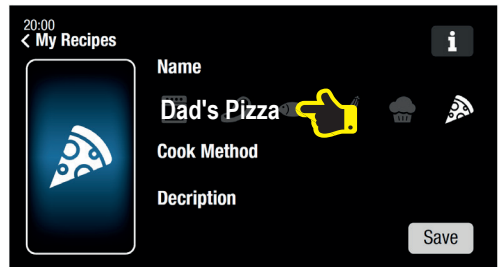

6. Select temperature and **Save**



continued overleaf



CREATING AND SAVING RECIPES (CONTINUED)

7. Add recipe description and  This can include method, ingredients etc.



8. New recipes will then be added into the **My Recipes** menu.

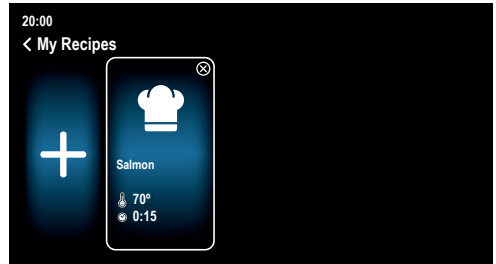

To cook with My Recipes

1. Press the desired recipe, then the **Cook** button to begin cooking.

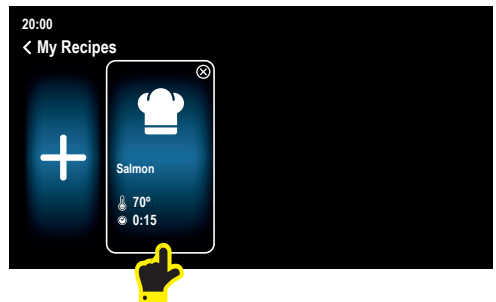

Note: When creating a new recipe ALL fields (Name, Temperature, Time and Description) must be completed in order to save the recipe.



ECOSTEAM CLEAN

Special cleaning method for cavity.
See Looking after your appliance section.

Note: ECO steam clean is only available on lower cavity.

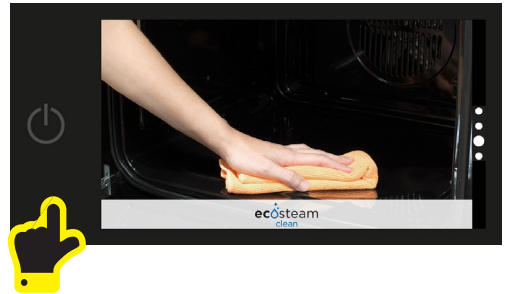

SETTINGS MENU

To access the Settings menu press the Settings icon  on the side bar.

Any changes to the settings are made by returning to the main settings menu.

You will be able to customise the following options for your hob:

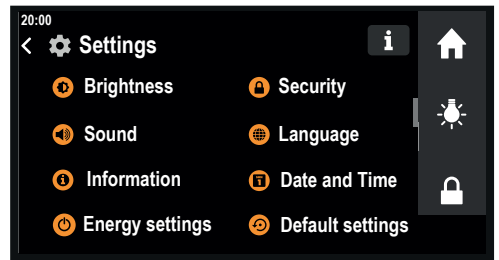

Brightness

Adjust the screen's brightness using the control bar. 

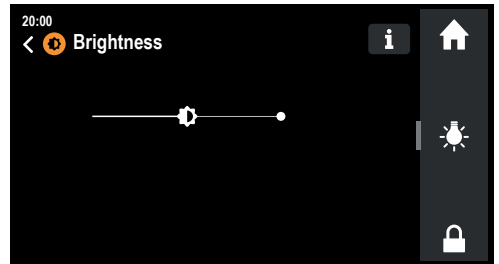

Sound

Adjust the volume or mute the sound (except the alarm) using the control bar. 

Turn off the button click sounds.

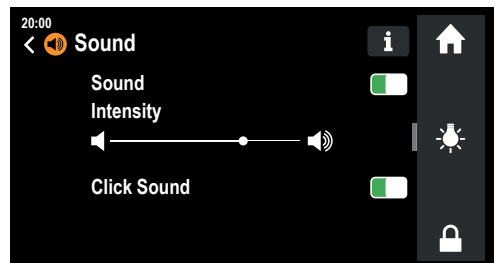



SETTINGS MENU(CONTINUED)

Information

Here you can find useful information about the device and how it works.

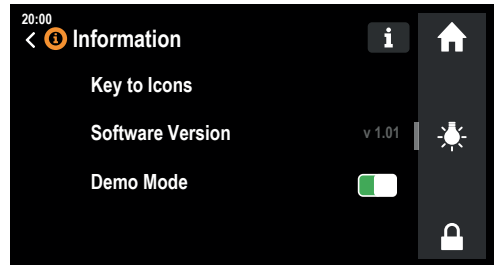

Energy Settings

When the selected waiting time is reached, **Standby mode** will be activated and the screen will show the clock.

Once **Standby mode** is activated, the waiting time will count again and enter **Hibernation Mode** once the waiting time is reached.

You can adjust the waiting time to **Standby mode** or **Hibernation Mode** and also the format of the clock on the standby screen.

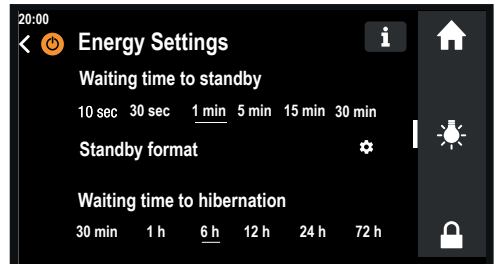

Security

Select the screen unlocking mode by pressing the screen for 2 seconds or set up a pattern or PIN code.

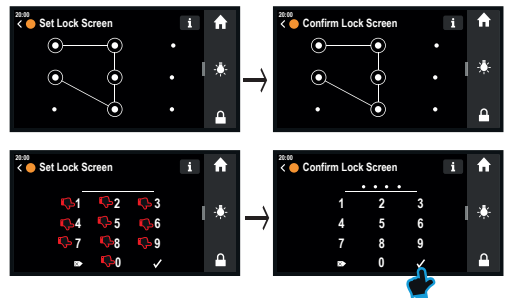
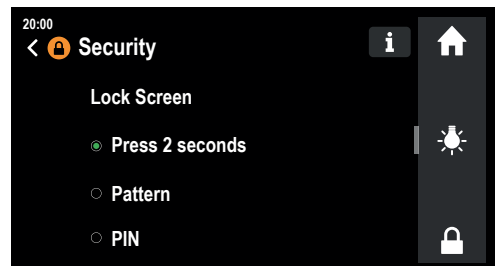



SETTINGS MENU(CONTINUED)

Language

Select the display language.

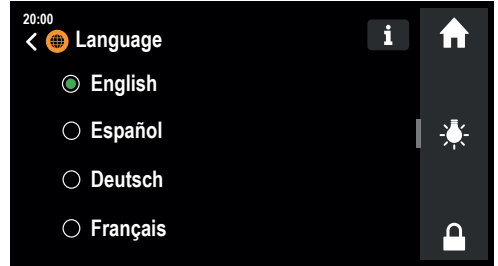

Setting the language

Select, and then press back to confirm.

Just like the other android 4.0 system, the oven TFT needs to be manual restarted in order to successfully change the words on all the corners after you selected a new language for your system.

Date & Time

The date and time options are displayed. Alarm options are also displayed.

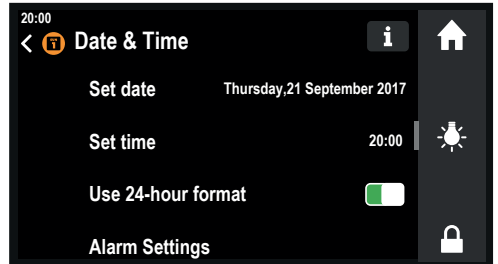

Setting the date

Select, and then press back to confirm.

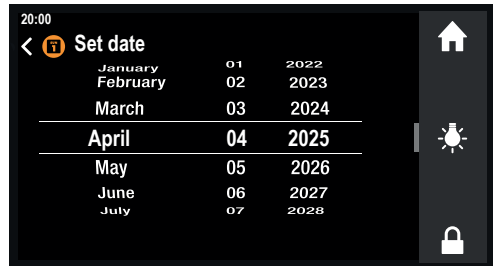

Setting the time

Select, and then press back to confirm.

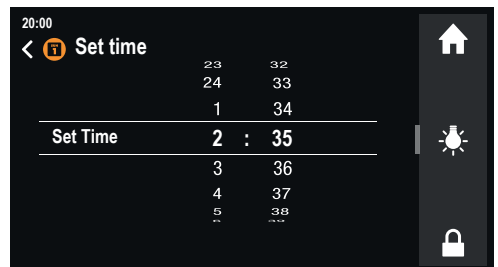



SETTINGS MENU(CONTINUED)

Alarm settings

Adjust the volume or mute the sound (except the alarm) using the control bar.

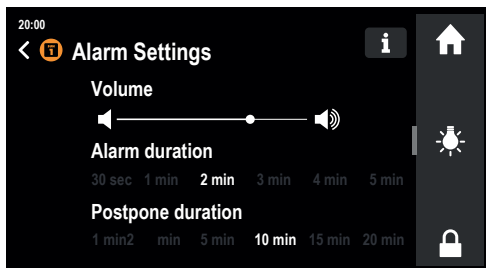

Default Settings

This option restores all settings back to the initial factory settings.

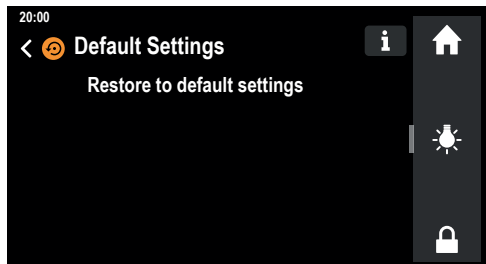



LOOKING AFTER YOUR APPLIANCE

IMPORTANT: Always switch off the electricity supply before performing any maintenance work.

Wait for the appliance to cool down before starting cleaning.

General Cleaning

- Failure to maintain the oven regularly and to keep it clean may cause deterioration of the surface and reduce the service life of the appliance, and thus cause risks as a result of these.
- Ensure that the cleaning agents you use when cleaning your product does not have particles that can scratch enamelled or painted surfaces.
- Do not clean the oven with materials such as bleaches, nitric acid or hydrochloric acid or cleaning agents that contain abrasives (wire wool, cleaning powder, oven sprays, abrasive hard sponges), acids or chlorine.

Never use:

- **Undiluted washing-up liquid**
- **Detergent intended for dishwashers**
- **Scouring agents**
- **Harsh cleaning agents**
- **Abrasive sponges**
- **High-pressure cleaners or steam jet cleaners**

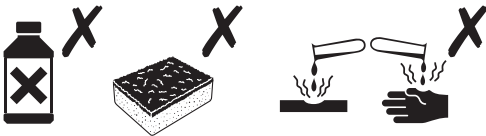



USING ECOSTEAM CLEAN FUNCTION



Note: ECO steam clean is only available on lower cavity.

1. Before using the steam cleaning function, remove all accessories from the oven.
2. Pour 200 ml of water and washing up liquid (a coffee spoon), mix and put water and soap carefully inside.
3. Close the oven door and press **NEXT**.
4. Wait for the procedure to complete and then follow the instruction on screen to remove the remaining dirt.
5. Press **FINISH** when finished cleaning.

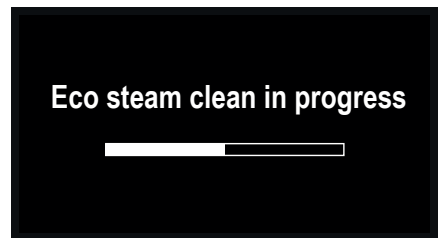
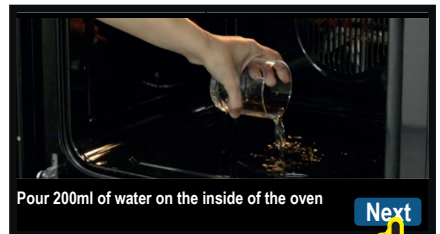

If **Ecosteam clean** is selected by mistake, just press **FINISH** to stop at once and exit to home screen.



LOOKING AFTER YOUR APPLIANCE

WARNING: RISK OF BURNS. Always ensure that the oven has cooled down prior to cleaning.

Cleaning the interior of the oven

- Clean the oven thoroughly using a proper oven cleaning agent at regular intervals.
- The best time to clean the enamelled surface inside the oven is when the oven is warm.

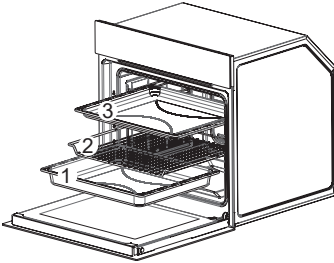

- Remove all the trays and the grill (1, 2 & 3). Clean the interior by wiping with a cloth dampened with warm, soapy water. Then, wipe once more with a damp cloth and dry.
- Do not use abrasive materials such as sandpaper, steel/wire wool. Otherwise, the enamelled part of the oven may get damaged.
- You may use cleaning agents used for stainless steel or some vinegar in case of harsh stains.
- The stains left by such fluids may harm the brightness of the oven, but does not affect its performance in any way.
- Do not use the oven for storage purposes by putting food such as bread, cakes, cookies, etc. inside the oven.

Cleaning the side walls of the oven

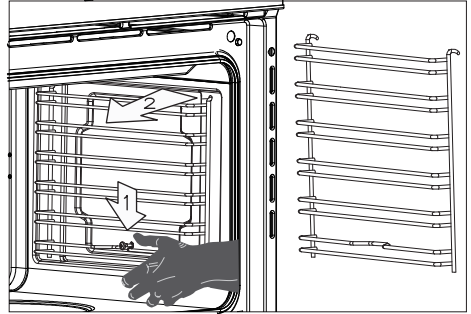

- Pull each rack down and out to disengage the lugs from the carcass.
- Replace in reverse order ensuring the lugs are fully engaged in the carcass wall.



LOOKING AFTER YOUR APPLIANCE

WARNING: RISK OF BURNS.
Always ensure that the oven has cooled down prior to cleaning.

Removal of the Oven Door

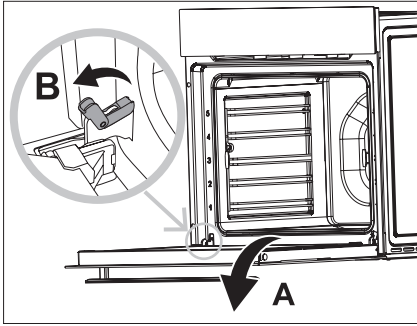

1. Open the door completely by pulling the oven door towards you.
2. Then, bring the hinge lock to the widest angle as shown in the diagram above. Bring both hinges that connect the oven door to the oven to the same position.

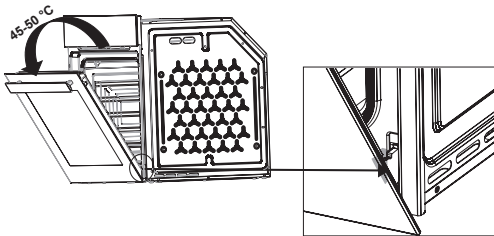

3. Close the oven door so that it contacts the hinge lock at 45°-50° as shown in the diagram above.

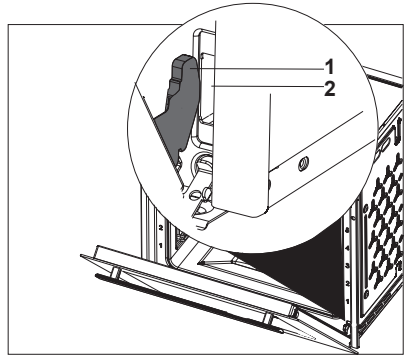

4. Remove the hinges (1) from the hinge housing (2) by holding the door with both hands to remove the oven door as shown in the diagram above.

IMPORTANT: Reverse the removal procedure for installation procedure of the door. Remember to the close the clips on the hinge housing while installing the door.

Cleaning the Oven Glass

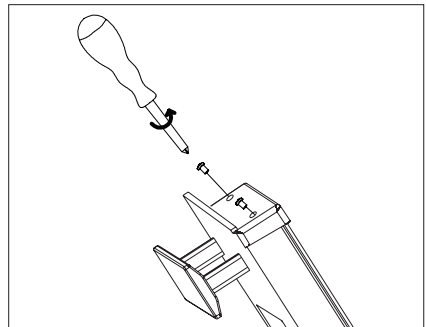

1. Open the door completely by pulling the oven door towards you as shown in the diagram above.



LOOKING AFTER YOUR APPLIANCE

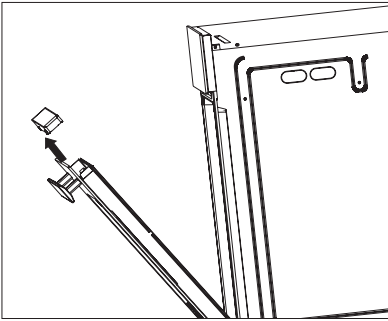

2. Remove the door top plastic as shown in the diagram above.

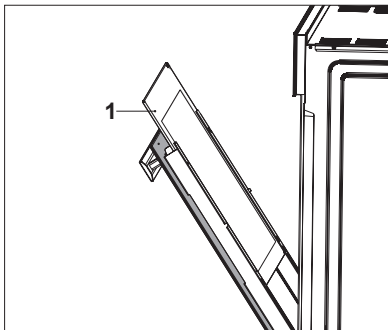

3. Remove the internal glass (1) of the oven to clean it as shown in the diagram above.

4. Wipe the glass cover with soft sponges and cloths cleaning and drying.

5. Do not use harsh abrasive cleaning agents and sharp metal scrapers to clean the oven glass. Cleaning in such a way may scratch the surface of the glass and may cause the glass to break.

6. Do not lean over and apply weight on the oven door.

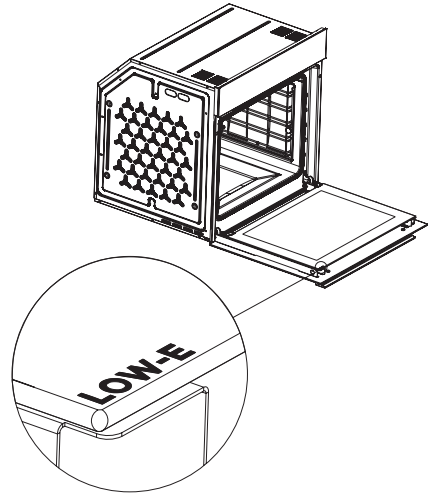

7. When the door of your oven is in horizontal position, the **LOW-E** inscription on the interior glass of your oven door will be as shown in the diagram above.

Reverse the same procedure to install the oven glass.

Cleaning the Oven Door Gasket

- Condensation may occur inside the front door and on the door gasket when the oven is operated for a long period. Remove the possible condensation using a dry cloth or sponge.
- Inspect the condition of this gasket at regular intervals. Clean without using abrasive cleaning agents when required.
- Door may not closed properly when dirt is collected on the door gasket after some time.
- Please contact Customer Services if the door gasket becomes damaged. Do not use the oven until it is repaired.

IMPORTANT: As the door loses weight when the glass is removed, it may close abruptly and cause injuries.



LOOKING AFTER YOUR APPLIANCE

Lamp Replacement

Bulb Power (W)	25
Lampholder/Socket	G9
Bulb Voltage (V)	220-240
Size (mm)	42 x 65
Energy Class	G



MAX 25W

It indicates the maximum power consumption of the lamp. A lamp with same power rating should be used when replacing the lamp.

WARNING: Disconnect the electrical supply of the oven. Leave the lamps to cool down first because they could burn your hands when they are hot.

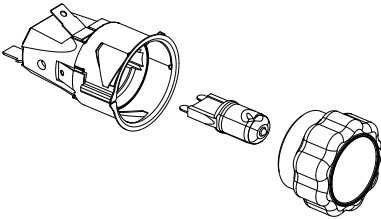

- Turn lamp cover anti-clockwise to remove. Pull out the faulty bulb and directly insert new bulb with the same rating as shown in the diagram above. Screw the lamp cover back on by turning clockwise to tighten.



AFTER SALES & SERVICE SUPPORT



For after sales, service enquiries & spares support

Please contact: **0333 247 1128**

Monday to Friday: 9am-5pm

Saturday: 9am-1pm

Email enquiries: wrenservice@apelson.co.uk

Dedicated spares at: karlson.co.uk