

CUL57PGSS.2

Oven Instruction Manual

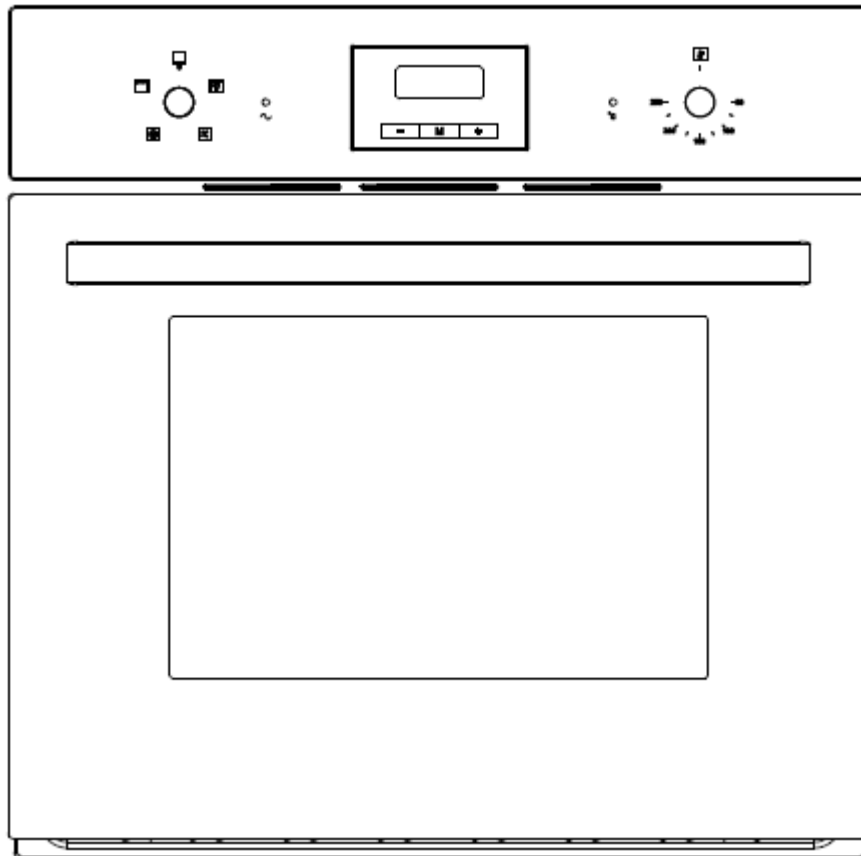

Content

1.....	Important safety information
2.....	Installation
3.....	Prior to start up of the appliance
4.....	Selecting a cooking function and temperature
5.....	Troubleshooting
6.....	Maintenance and cleaning
7.....	Environmental note
8.....	Transportation

Important safety information

This User Instruction Manual contains important information, including safety & installation points, which will enable you to get the most out of your appliance. Please keep it in a safe place so that it is easily available for future reference; for you or any person not familiar with the operation of the appliance.

Warning:

- The appliance and its accessible parts become hot during use. Care should be taken to avoid touching heating elements.
- Children less than 8 years of age shall be kept away unless continuously supervised.
- This appliance can be used by children aged from 8 years and above and persons with reduced physical, sensory or mental capabilities or lack of experience and knowledge or they have been given supervision or instruction concerning use of the appliance in a safe way and understand the hazards involved. Children shall not play with the appliance. Cleaning and user maintenance shall not be made by children without supervision.
- A steam cleaner is not to be used.
- Accessible parts may become hot during use. Young children should be kept well away when in use.
- Do not use harsh abrasive cleaners or metal scrapers to clean the oven door glass as this can scratch the surface, which may result in the oven glass shattering.
- Do not use abrasive products to clean the glass door panel to avoid scratching it. Otherwise, severe failure might happen to the appliance.

unless necessary for cooking or cleaning purposes.

- The appliance must not be installed behind a decorative door in order to avoid overheating.
- The air must not be discharged into a flue that is used for exhausting fumes from appliances burning gas or other fuels.

Operation:



Warning! Danger of fire!

- Do not allow paper or cloth to come in contact with any heating element.
- Never store or use corrosive chemicals, vapors, flammables or nonfood products in or near oven. It is specifically designed for use when heating or cooking food. The use of corrosive chemicals in heating or cleaning will damage the appliance and could result in injury
- If food inside an oven should ignite, keep door closed. Switch off the oven and disconnect from supply power.
- Exercise caution when opening the door. Standing to the side, open the door slowly and slightly to let hot air and/or steam escape. Keep your face clear of the opening and make sure there are no children or pets near the oven. After the release of hot air and/or steam, proceed with your cooking. Keep doors closed at all time
- Only use utensils that are suitable for use with ovens.



Warning!

Danger of explosion!

- Liquids and other foods must not be heated in sealed containers since they are liable to explode.
- If smoke is observed, switch off the oven and keep the door closed in order to stifle any flames.
- Do not allow any accessories or electric cables to contact the hot parts of the appliance.



Warning!

Hot surfaces! Risk of burns!

- During use the appliance becomes hot. Care should be taken to avoid touching heating elements inside the oven.
- Warning! Accessible parts may become hot during use. Young children should be kept away.
- Never move racks or pans when they are hot. Wait until they cool.

Safety advices:



IMPORTANT!

Always switch off the electricity supply at the mains during installation and maintenance.

General Information

- This appliance is designed for domestic household use and can be built into a standard kitchen cabinet or housing unit.
- The appliance surfaces will become hot during use and retain heat after operation.
- Any damage caused by the non-compliance of temperature tolerance of

oven during installation or by the too close distance between the furniture and the oven will be borne by the owner.

- This appliance is not intended for use by persons (including children) with reduced physical sensory, or mental capabilities, or by those who lack experience and knowledge, unless they have been given supervision and instruction concerning the use of the appliance by a person responsible for their safety .

Installation

- The oven must be installed in accordance with the installation instructions and all measurements must be followed.
- All installation work must be carried out by a competent person or qualified electrician.

Children

- Please dispose of the packaging material carefully. Packaging material can be dangerous to children.
- Make sure to keep children away from the appliance, children should be supervised to ensure that they do not play with the appliance. It might be dangerous to allow the children to touch the appliance.

General Safety

- Do not place heavy objects on the oven door or lean them on the oven door when it is open, as it may cause damages to the oven door hinges.
- Do not place those baked hot oil or fat unattended on unattended areas, as it will be a fire risk.
- Do not place pans or baking trays directly on the base of the oven cavity,

even if aluminum foil is placed below them.

- Do not allow cable or plug to come into contact with the heating areas of appliance.
- Do not install the appliance next to curtains or soft furnishings.
- Do not attempt to lift or move cooking appliances by using the oven door or handle, as this may cause damage to the appliance or result in injury to the person lifting the appliance.

Electrical safety

- If the supply cord is damaged, it must be replaced by the manufacturer, its service agent or similarly qualified persons in order to avoid a hazard.
- The appliance must be placed in such a way, that the power supply is accessible at all times.
- Before connecting the appliance to the power supply, check that the power supply voltage and current rating corresponds with the power supply details shown on the appliance rating label.
- Never use a damaged appliance! Disconnect the appliance from the power source and contact your supplier if it is damaged.
- Danger of electric shock! Do not attempt to repair the appliance yourself. In case of malfunction, repairs are to be conducted by qualified personnel only.
- To avoid damaging the cord, do not squeeze, bend or chafe it on sharp edges. Keep it away from hot surfaces and open flames as well.
- Lay out the cord in such a way that no unintentional pulling or tripping over it is possible.
- Do not open the appliance casing under any circumstances. Do not insert

any foreign objects into the inside of the casing.

- Never use accessories which are not recommended by the manufacturer. They could pose a safety risk to the user and might damage the appliance. Only use original parts and accessories.
- Keep the appliance away from any hot surfaces and open flames. Always operate the appliance on a level, stable, clean and dry surface. Protect the appliance against heat, dust, direct sunlight, moisture, dripping and splashing water.
- Do not place objects with open flames, e.g. candles, on top of or beside the appliance.
- **WARNING:** Ensure that the appliance is switched off before replacing the lamp to avoid the possibility of electric shock.
- The fixed wiring for applicant shall have an all-pole disconnection device.



Safety:

- Attention, the glass is extremely fragile. Always wear gloves when handling.
- For your safety, this product is made of tempered glass. This type of glass is highly resistant but has the feature to retain the "memory" of shocks.
- Therefore, it should handle the product with the greatest care to avoid shocks and twists, especially during installation.
- Avoid installing this type of product in areas where it would be highly exposed to shocks.
- Do not let children play with the product.
- Do not stick adhesive film on the glass surface. In case of breakage, it would generate large pieces that could be dangerous

Electrical connection



Danger of electric shock!

- Any electrical installation must be carried out by an authorised professional.
- All fittings must be installed by a competent person in accordance with local regulations. If in doubt, consult a qualified electrician.
- Important! Always switch off the electricity supply at the mains during installation and maintenance. We recommend that the fuse is withdrawn or circuit breaker switched off at the distribution board whilst work is in progress.
- This product must be earthed – if no earth feed wire is available, consult an electrician.
- Means for disconnection must be incorporated in the fixed wiring in accordance with the wiring rules. To achieve this install appropriate switched fused connection unit.
- Note! A switched fused connection unit having a contact separation of at least 3mm in all poles should be connected in fixed wiring.
- Connect the incoming positive, neutral and earth cables to the terminals of the switched fused connection unit. Ensure connections are tight.
- The spur outlet must still be accessible even when your oven is located in its

housing to enable the appliance to be disconnected from the mains supply.

Cleaning

- Always disconnect the power supply prior to cleaning the appliance. If the switched fused connection unit is difficult to reach, shut off the power supply by using the corresponding circuit breaker at the distribution board.
- Clean the appliance thoroughly before first use. The oven should be cleaned regularly and any food deposits removed.
- Never clean the oven surfaces by steam cleaning.
- The oven cavity should only be cleaned with warm soapy water, using either a sponge or soft cloth. No abrasive cleaners should be used.
- Any stains that may appear on the bottom of the oven will have originated from food splashes or spilt food, these splashes occur during the cooking process. These could possibly be a result of the food being cooked at an excessively high temperature or being placed in cookware that is too small.
- You should select a cooking temperature and function that is appropriate for the food that you are cooking. You should also ensure that the food is placed in an adequately sized dish and that you use the drip tray where appropriate.

Installation

Electrical connection

Before connecting the appliance, make sure that the supply voltage marked on the Rating Plate corresponds with your mains supply voltage.

WARNING: THIS APPLIANCE MUST BE EARTHED.

- A suitable disconnection switch is to be incorporated in the permanent wiring. The switch is to be of approved type and positioned in accordance with local wiring and electrical rules and specifications. The switch must have 3 mm air gap contact separation in all poles, in the active (phase) conductor of the fixed wiring.

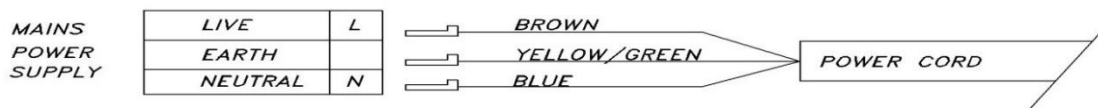

- To connect the oven power cord, loosen and remove the cover on the terminal block, in order to gain access to the contacts inside. Make the connection, securing the cord in place with the cable clamp provided and then immediately close the terminal block cover again.
- If you have to change the oven power cord, the earthing (yellow/green) conductor must always be 10 mm longer than the line conductors.
- The installation must include 1.2m of free cable within the enclosure for ease of installation and future maintenance.
- The mains cable must not touch any hot metal.
- Care must be taken to ensure that the temperature of the mains supply cable does not exceed 50°C.
- If the mains supply cable is damaged, then it must be replaced by an appropriate replacement which can be obtained from Spares Department.
- This oven can be plugged into an appropriate 3 pin socket.

Installing the oven into the kitchen cabinet

- The kitchen area should be dry and aired and equipped with efficient ventilation. When installing the oven, easy access to all control elements should be ensured.

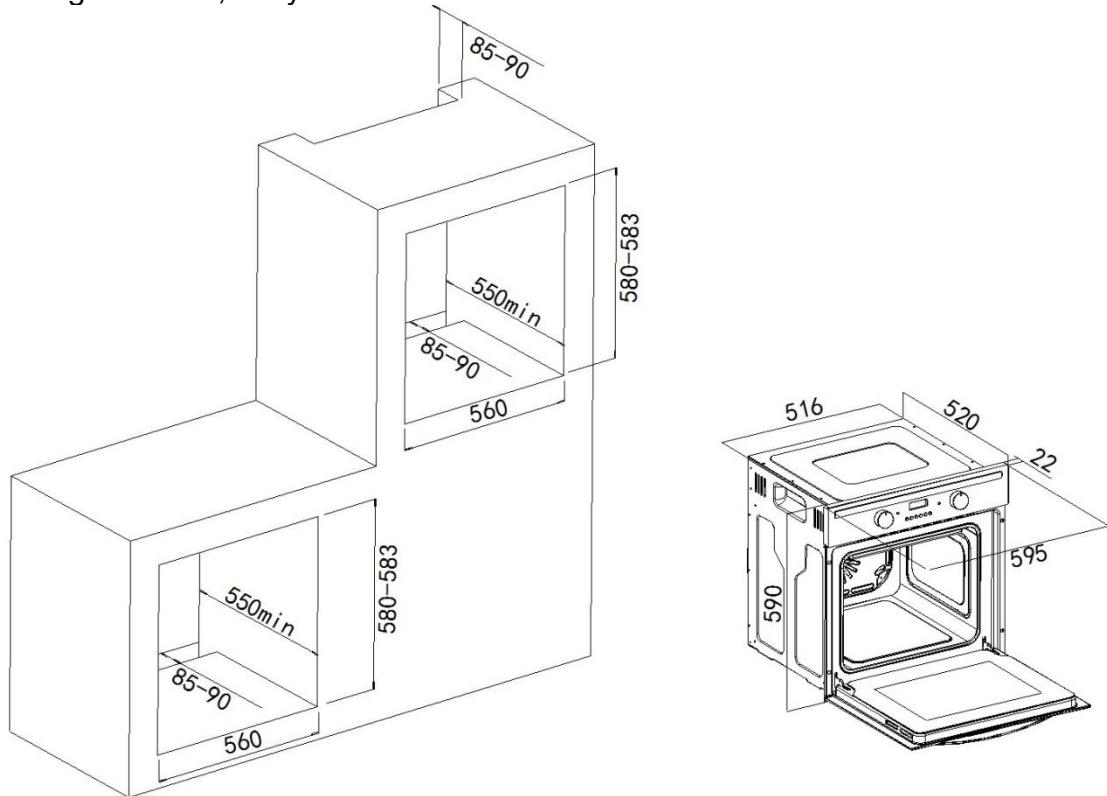

Positioning the appliance

- Ensure that the aperture that you will be fitting the oven into is of the size given in the above diagram.
- The oven must be fitted into an oven housing with the ventilation cut-outs shown in the “Ventilation requirements” section on the next page.
- Ensure that the rear panel of the furniture housing unit has been removed.
- Ensure that the oven has been securely fixed into the housing unit. The fixing of the oven into the housing is made by using four screws. These should be screwed through the oven cabinet and into the housing unit.

Ventilation requirements

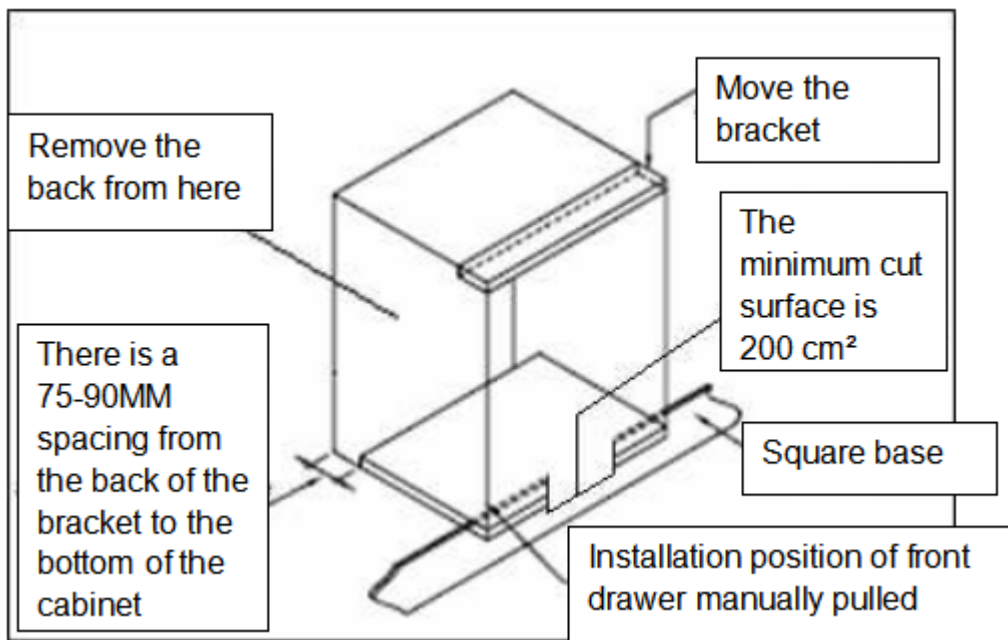

(Figure shows the ventilation and cut-out requirements for the installation of the appliance into a tall housing unit).

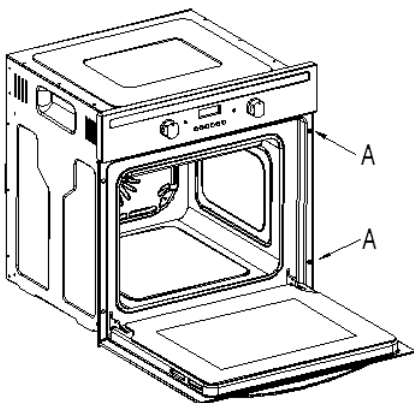

Ensure that the oven has been securely fixed into the housing unit. The fixing of the oven into the housing is made by using four screws. These should be screwed through the oven cabinet(A) and into the housing unit.

Prior to start up of the appliance

- Once this simple operation has been carried out the oven is ready to use for cooking.
- This appliance is exclusively for domestic use.
- Use the oven to cook food only.
- Before cooking, make sure all oven accessories that are not required are removed from the oven.
- Pre-heat the oven to the cooking temperature before using it.
- Place the cooking trays in the center of oven and leave space in between when using more than one, so that the air can circulate.
- Do not put oven trays on the base of the oven or cover it with aluminium foil. This will cause thermal accumulation. The cooking and roasting times will not coincide and the enamel may be damaged.
- Try to open the oven door as little as possible to see the food (the oven light remains on during cooking).
- Take care when opening the door to avoid contact with hot parts and steam.

A. Specifications

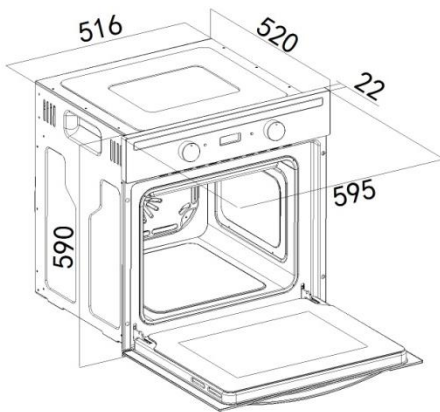

Dimensions

Height:590 mm
Width:595 mm
Depth:520 mm

Standard accessories:

- 1 x Grill shelf
- 1 x Baking tray

Specifications

- 4 functions
- Oven capacity:54 litres
- Thermostatically controlled grill
- Cooling fan

A tangential cooling fan is fitted inside of this appliance, to make the internal temperature of the oven stable and the external surface temperature lower. After the oven has been used the cooling fan will run on for a period of time, until the oven is sufficiently cooled.

B. Control panel

Here, you will see an overview of the control panel. Depending on the appliance model, individual details may differ.

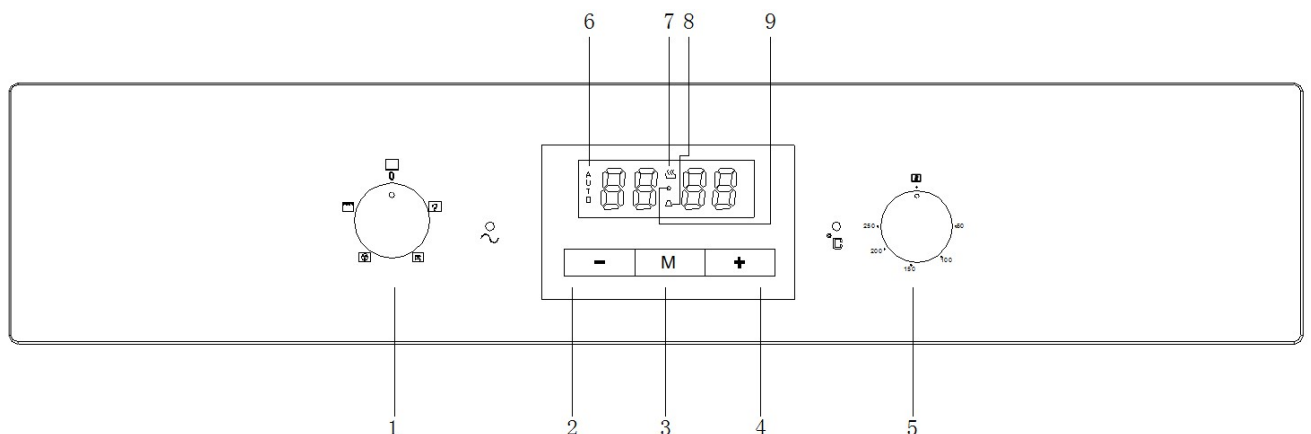

- 1) Oven function selector knob
- 2) Timer "minus time" button
- 3) Oven "Start" button
- 4) Timer "plus time" button
- 5) Thermostat control knob

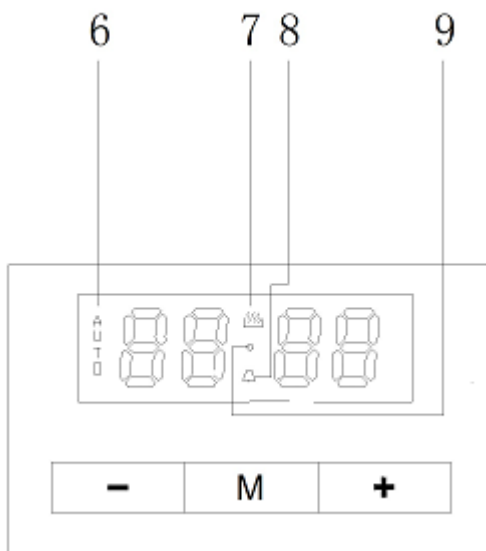

C.Oven programmer/timer display

- 6) "Auto" function symbol
- 7) Oven in use symbol
- 8) Clock symbol/"Minute minder" symbol
- 9) Decimal point symbol

Setting and using the oven programmer/timer

Before first use

- ✧ To remove any residue from the oven that may have been left from the manufacturing process, you should select the fan oven function and set the thermostat to its maximum temperature setting.
- ✧ It is perfectly normal for a smell to be produced during this process.
- ✧ You should make sure that any windows in the room are left open during this process.
- ✧ It is advisable for you not to remain in the room whilst the burning off process is taking place.
- ✧ You should leave the oven on maximum setting for 30 – 40 minutes.
- ✧ After the oven cavity has cooled, it should then be cleaned with warm soapy water, using either a sponge or soft cloth. No abrasive cleaners should be used.
- ✧ Outer parts of the oven should be cleaned with warm soapy water, using either a sponge or soft cloth. No abrasive cleaners should be used.
- ✧ We would recommend that an appropriate stainless steel cleaner and polish is regularly used on the stainless steel surfaces of this appliance.

Timer working status

Switching the timer status

The timer has 3 status, they are standby, function to be selected and working status.

Stand-by status: After connected to the power supply, the display screen displays the system time, the decimal point symbol flashes, it is the status before entering cooking function; If exceeds 1 min without any operation under standby mode, the display brightness automatically reduces, press any key to recover to the original brightness.

Function to be selected status: Long press program button under standby status, the display screen will show system time, it is the status when oven in use symbol and decimal point symbol keep bright.

Working status: After completed setting any one of the system time, clock, cooking time or cooking end time, the display screen will show system time, and it is the status when corresponding working icon keep bright.

Status switching diagram refer to below:

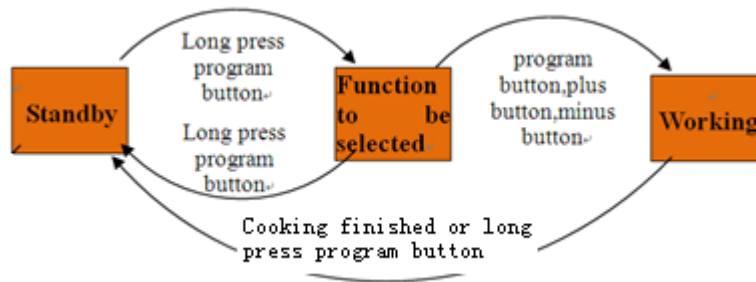

Status switching diagram

Timer function mode switching

Long press program button “M” for 3s enter to system time setting status, without any operation after 5S, system time, oven in use symbol “🔥” and decimal point symbol “●” keep bright display; you can circularly switch the oven timer function mode by program button “M”.

The operation flow and corresponding functional sequence are as followings:

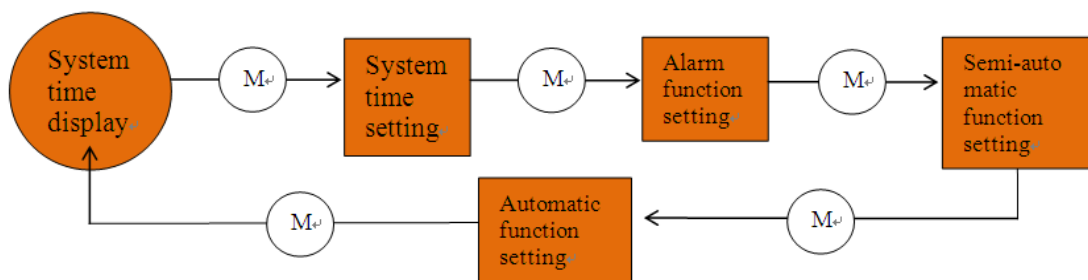

Timer function mode switching diagram

Operation instructions

◆ Power on

For the first time power on, the buzzer “beep” for one time to show that the timer enters into the standby state. The clock shows the time of the system and starts the timing. Power-on displays as “0:00”, the display screen displays the system time, the decimal point symbol “●” is flashing, 1 second 1 time, like Pic 5. You can push “⊕” to choose 3 kinds of ring tone, The default is the second ring tone.



Pic 5 Power-on default clock diagram (standby state)

◆ Start up and time setting

When the display is flashing, press “Ⓜ” for 3 seconds to start up the oven. Then oven in use symbol “🔥” lights up. The clock value is always on and the current system time is

displayed, and decimal point symbol “●” twinkles. When decimal point symbol “●” twinkles, press “⊕” or “⊖” to set the system time. After choosing the time, lift the finger off the buttons and wait for 5 seconds, then decimal point symbol “●” stop twinkling. It means time is well set. Like pic 8. Whenever user wants to set the time again, In the status of pic 7, push “Ⓜ” one time, when user sees decimal point symbol “●” twinkles, then can set the time again



Pic 6 Clock setting state diagram (second icon flickering)



Pic 7 Feature to be selected state diagram (second icon always bright)

Press button “Ⓜ” again for 3 seconds, oven is turned off and returns to standby status. The display of pic 6 is flashing.



Pic 8 System time well set diagram

Note 1 : System time setting range is 0 : 00-23 : 59.



Note 2 : When setting the time for each function of the timer, you can set the time by short press or long press “⊕” and “⊖”, short press will add 1 minute or reduce 1 minute each press of the button, while long press will quickly increase or decrease the time by 1 minute, so it can set the time fast.



◆ Alarm clock setting function

In the state of function to be selected, when the display shows the system time, oven in use symbol “☹” and decimal point symbol “●” keep bright, press “Ⓜ” two times, then the clock icon “⚠” twinkles, and the screen display changes to the alarm clock time (First set default display “0:00”), alarm clock time and decimal point symbol “●” always display, like pic 9. When the alarm clock icon “⚠” twinkles, Press “⊕” or “⊖” to set the clock. Alarm clock well set diagram like pic 10 (Set 10 minutes).







Pic 9 Alarm clock setting initial state
 (alarm clock icon flickering)
 Pic 10 Alarm clock well set
 (alarm clock icon flickering)

After choosing the time, lift the finger off the buttons and wait for 5 seconds, then the alarm clock icon “” stops twinkling and changes to always bright, display screen shows system time, oven in use symbol “”, decimal point symbol “” and system time keep bright. It means time is well set. See Pic 11.

Whenever user wants to adjust the clock, in the working status, push “” two times, when user sees the alarm clock icon “” twinkles, it will show the set clock or the time left, and user can adjust the clock again. After setting is done, the display will change back to system time.



Pic 11 Alarm clock working status diagram
 (alarm clock icon always bright)
 Pic 12 Alarm clock time over diagram
 (alarm clock icon flickering)







For example, set the clock 10 minutes. After 10 minutes, display screen shows system time, oven in use symbol “”, decimal point symbol “” and system time keep bright, the alarm clock icon “” twinkles, buzzer will prompt the user for 5 minutes, reminding the user that the alarm clock time is over. Like Pic 12. Pressing any key can stop the buzzer and extinguish alarm icon “”. Like Pic 13.



Pic 13 Cancel alarm clock icon display diagram (After alarm clock over)

Note : Alarm clock time setting range is 0 : 00-23 : 59.

◆ **Cooking time setting function**





In the state of function to be selected, press button “” 3 times, then the icon “A” and oven in use symbol “” twinkle. The screen shows the cooking time (First set default display “0·00”), cooking time and decimal point symbol “” keep bright display, see Pic 14. When the icon “A” and oven in use symbol “” twinkle, user can set the cooking time by pressing “” or “”. Well set diagram see Pic 15 (Set 30 minutes).

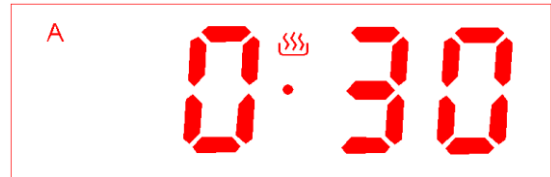

Pic 14 Cooking time setting initial state



Pic 15 Cooking time well set state

After choosing the time, lift the finger off the buttons and wait for 5 seconds, then the icon “A” and oven in use symbol “” stop twinkling and change to always bright display. It means time is well set. Whenever user wants to adjust the timer, in the working status, push “” three times, when user sees the icon “A” and oven in use symbol “” twinkles, it will show the set timer or the time left, and user can adjust the timer again. After setting is done, the display will change back to system time, decimal point symbol “” and system time keep bright. See Pic 16.





Pic 16 Cooking time working status
(All the icons always bright)

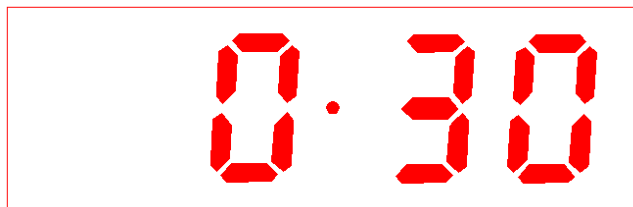

Pic 17 Cooking time over diagram
(All the icons flickering)



Pic 18 Cancel “A” function symbol display diagram (After cooking time over)

For example, set the timer 30 minutes. After 30 minutes, display screen shows system time, oven in use symbol “” extinguishes, system time keeps bright, decimal point symbol “” and “A” function symbol twinkle, buzzer will prompt the user for 5 minutes, reminding the user that the cooking time is over. Like Pic 17. Pressing any key can stop the buzzer and

extinguish "A" function symbol. Like Pic 18.

Note 1 : Cooking time setting range is 0 : 00-10 : 00.

Note 2 : Not setting cooking time after power on, the appliance will automatically shut down after working 10 hours, without buzzer reminding function.

Note 3: After the cooking time setting is completed and entering the working state, if you need to query the previously set cooking time or reset the cooking time, you can press the function selection key "M" to query for 3 times or reset the cooking time in the working state.

◆ Cooking end time setting function

In the state of function to be selected, press button "M" 4 times, then icon "A" and oven in use symbol "🔥" twinkle, display screen shows cooking end time (The first setting shows the current system time by default), cooking end time and decimal point symbol "●" keep bright. Display effect see Pic 19 (Suppose current system time is 0:00). When the icon "A" and oven in use symbol "🔥" twinkle, you can set cooking end time by pressing "⊕" or "⊖", well set diagram see Pic 20 (Suppose cooking end time is 0:30).



Pic 19 Cooking end time setting initial state Pic 20 Cooking end time well set state

After choosing the time, lift the finger off the buttons and wait for 5 seconds, then the icon "A" and oven in use symbol "🔥" stop twinkling and change to always bright. Display screen will show system time, decimal point symbol "●" and system time keep bright. It means time is well set. See Pic 21.

Whenever user wants to adjust the timer, in the working status, push "M" four times, when user sees the icon "A" twinkles, it will show the set cooking end time, and user can adjust the time again. After setting is done, The display will change back to system time.





Pic 21 Cooking end time working status
(All the icons always bright)

Pic 22 Cooking finished diagram
(All the icons flickering)

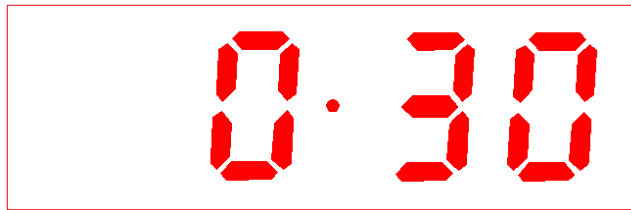

Pic 23 Cancel "A" function symbol display diagram (After cooking finished)

For example, the system time is 0:00 like pic 19. Set cooking end time 0:30, like pic 20. When the time reaches 0:30, display screen shows system time, oven in use symbol "🔥" extinguishes, system time keeps bright, decimal point symbol "•" and "A" function symbol twinkle, buzzer will prompt the user for 5 minutes, reminding the user that the cooking is finished. Like Pic 22. Pressing any key can stop the buzzer and extinguish "A" function symbol. Like Pic 23.

Note 1 : Cooking end time is beyond current system time plus cooking time, and within 23:59.

Note 2: After the cooking end time setting is completed and entering the working state, if you need to query the previously set cooking end time or reset the cooking end time, you can press the function selection key "M" for 4 times to query or reset the cooking end time in the working state.

◆ Cooking reservation function

In the state of function to be selected, user can reserve the cooking time, by setting how much time to cook and when to have the dish ready.

First, press button "M" 3 times, then the icon "A" and oven in use symbol icon "🔥" twinkle. The screen shows the cooking time (First set default display "0:00"). When the icon "A" and oven in use symbol "🔥" twinkle, user can set the cooking time by pressing "⊕" or "⊖".

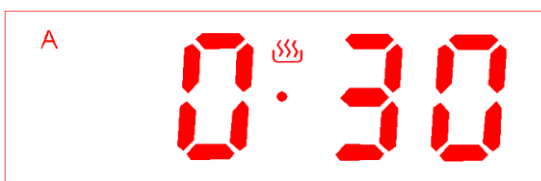



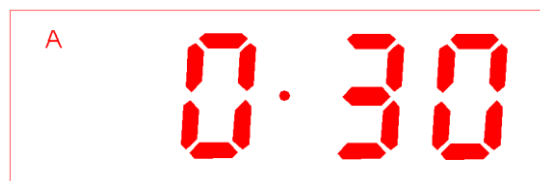

Pic 24 Cooking time well set diagram



Pic 25 Reservation function setting initial state

Second, press "M" one time again, when icon "A" twinkles, user can set the time that expect the cooking finishes at, by pressing "⊕" or "⊖". After choosing the time, lift the finger off the buttons and wait for 5 seconds, then the icon "A" stops twinkling. It means time is well set.

Whenever user wants to adjust the timer, in the working status, press “” three times to adjust the cooking period, or press “” four times to adjust the ending time. After setting is done, The display will change back to system time.

For example, the system time is 0:00. First, set cooking time 30 mins like pic 25. Second, set cooking end time 1:00, like pic 26. Then the oven is back to waiting mode. When the time reaches 0:30, the oven automatically starts to cook. It cooks for 30 mins and stop at the set time 1:00, display screen shows system time, oven in use symbol “”extinguishes, system time keeps bright, decimal point symbol “” and “A” function symbol twinkle, buzzer will prompt the user for 5 minutes, reminding the user that the cooking is finished . See Pic 29. Pressing any key can stop the buzzer and extinguish “A” function symbol. Like Pic 30.

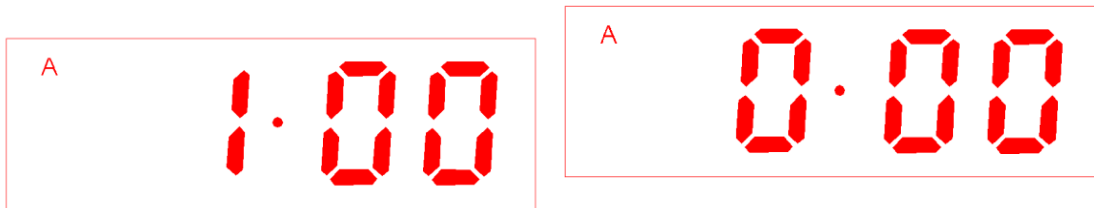

Pic 26 Reservation function well set state Pic 27 Reservation function start state

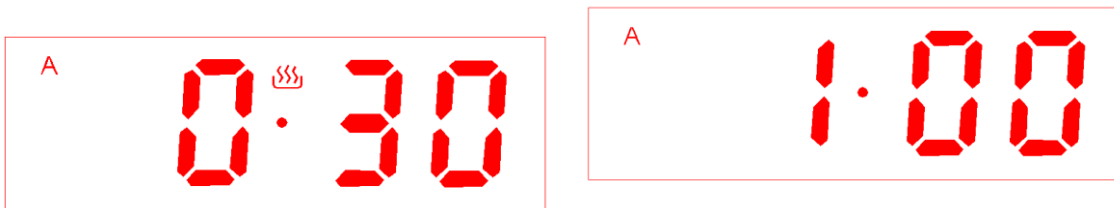



Pic 28 Cooking function start diagram

Pic 29 Cooking function end diagram



Pic 30 Cancel “A” function symbol display diagram(After cooking finished)

Note : Cooking time setting range is within 10 hours.

When the oven under the reservation function, during working process: If the oven door closes, the oven will remain working properly; if the oven door open, the display displays the system time with digital tube flashing, and the auto icon "A", system time second icon "", "" icon will always bright to remind the users since the oven door is open state, the oven will stop cooking (pause heating, oven lights out), but still start the buzzer reminder at the end of the reservation.

◆ Selecting the audible signal

The audible signal has 3 tones. To adjust the signal you should proceed as follows:

- ✧ Under standby mode, that is when display screen shows system time, decimal point symbol “●” twinkling, audible signal can be adjusted by pressing the plus button “⊕” to choose the 3 tones, press one time choose one kind. It is the second kind of tone by default when power on.

Selecting a cooking function and temperature

- When your appliance is connected to your mains supply for the first time, the power indicator light will come on, after selecting the cooking function and setting a temperature, the operating light will come on and the oven will start working, finally setting the cooking time; (the cooking time is from 0min to 120mins, revolving the knob in clockwise direction to the corresponding time on panel when setting the cooking time.
- The oven function selector knob should be used to select the particular mode of cooking that you require. The appliance will utilise different elements within the oven cavity, depending on the oven function that you select. When a function is selected, the power indicator light will come on.

Using your oven

Selecting an oven function

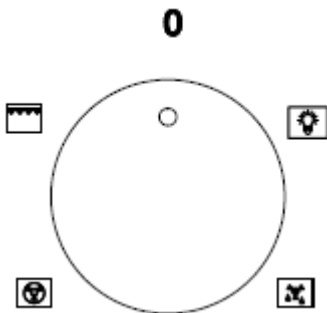

The oven function selector knob should be used to select the particular mode of cooking that you require. The appliance will utilise different elements within the oven cavity, depending on the oven function that you select. When a function is selected, the power indicator light will come on.

Four functions digital-timer model & the function mode

You have 4 functions for choices. Select cooking function according to different food.



OVEN LIGHT: This mode switches on the oven light and other electric devices do not work.



DEFROST: The fan runs without heat to reduce the defrosting time of frozen foods. The time required to defrost the food will depend on the room temperature, the quantity and type of food.



FAN OVEN: This method of cooking uses the circular element whilst the heat is distributed by the fan. This results in a faster and more economical cooking process. The fan oven allows food to be cooked simultaneously on different shelves, preventing the transmission of smells and tastes from one dish onto another.



FULL GRILL: This method of cooking utilises the inner and outer parts of the top element, which directs heat downwards onto the food. This function is suitable for grilling medium or large portions of sausages, bacon, steaks, fish etc.

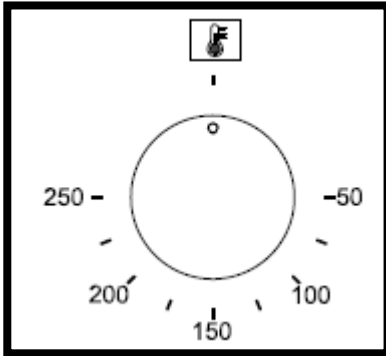

Temperature control

The oven thermostat control knob sets the required temperature of the oven. It is possible to regulate the temperature within a range of 50 - 250°C.

Turn the control knob clockwise.

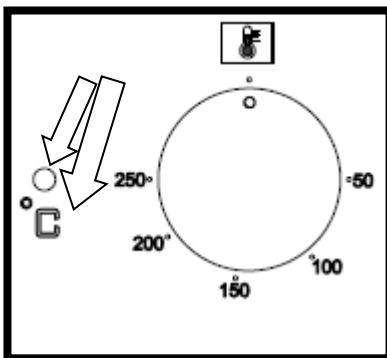

Oven operating light

This light will come on to indicate that the oven's heating elements are in operation. The light will turn off when the temperature set on the thermostat control knob has been reached. It will cycle on and off throughout the cooking time.

You should not place food inside the cavity, until the correct cooking temperature has been reached.

Cooking guidelines

- Please refer to the information given on food packaging for guidance on cooking temperatures and times. Once familiar with the performance of your appliance, temperatures and times can be varied to suit personal preference.
- If you are using the fan oven function, then you should follow the information given on the food packaging for this particular mode of cooking.
- Make sure that frozen foods are thoroughly thawed before cooking, unless the instructions on the food packaging advise that you can "cook from frozen".
- You should pre-heat the oven and not place food inside of it until the oven operating light has gone off. You can choose not to pre-heat when using the fan oven mode; however you should extend the cooking time given on the food packaging by approximately ten minutes.
- Before cooking, check that any accessories that are not required are removed from the oven.
- Place cooking trays in the centre of the oven and leave gaps between the trays to allow air to circulate.
- Try to open the door as little as possible to view the dishes.
- The oven light will remain on during cooking.

Warnings

- Keep the oven door closed when using any of the grill functions.
- Do not use aluminium foil to cover the grill pan or heat items wrapped in aluminium foil under the grill. The high reflectivity of the foil could potentially damage the grill element.
- You should also never line the base of your oven with aluminium foil.
- During cooking, never place pans or cookware directly onto the bottom of your oven. They should always be placed on the shelves provided.
- The grill heating element and other internal components of the oven becomes extremely hot during operation, avoid touching it inadvertently when handling the food which you are grilling.
- **Important:** Be careful when opening the door, to avoid contact with hot parts of the oven and steam.
- The drip tray handle should only be used to reposition the drip tray and NOT for removing it from the oven cavity. When removing the drip tray, you should ALWAYS use an oven glove.
- The drip tray handle should not be left in position when the appliance is switched on.
- A steam cleaner is not to be used.
- **Warning:** Accessible parts may become hot during use. Young children should be kept well away when in use.
- Do not use harsh abrasive cleaners or metal scrapers to clean the oven door glass as this can scratch the surface, which may result in the oven glass shattering.

Troubleshooting

Fault	Cause	Solution
Oven doesn't work.	Something at the connection is wrong, or it 's not connected.	Turn off main supply and check if some wire has been disconnected.
	Power supply connections are loose.	Turn off main supply and check if some wire has been disconnected.
	Something at house installation is wrong.	Turn off main supply and check if some wire has been disconnected.
Oven light doesn't work.	Light bulb is blown.	Replace bulb as described in the manual in the section "Maintenance and cleaning".
Oven will not heat.	No function is selected.	Choose a cooking function turning the selector.
	No temperature is selected.	Choose a temperature turning the selector.

Maintenance and cleaning

- The oven should be cleaned after every use. When cleaning the oven the lighting should be switched on to enable you to see the surfaces better.
- The oven chamber should only be washed with warm water and a small amount of washing-up liquid.
- After cleaning the oven chamber wipe it dry.
- Never clean the oven surfaces by steam cleaning.
- The oven cavity should only be cleaned with warm soapy water, using either a sponge or soft cloth. No abrasive cleaners should be used.
- Any stains that may appear on the bottom of the oven will have originated from food splashes or spilt food, these splashes occur during the cooking process. These could possibly be a result of the food being cooked at an excessively high temperature or being placed in cookware that is too small.
- You should select a cooking temperature and function that is appropriate for the food that you are cooking. You should also ensure that the food is placed in an adequately sized dish and that you use the drip tray where appropriate.
- Outer parts of the oven should only be cleaned with warm soapy water, using either a sponge or soft cloth. No abrasive cleaners should be used.
- If you use any form of oven cleaner on your appliance, then you must check with the manufacturer of the cleaner that it is suitable for use on your appliance.
- Any damage that is caused to the appliance by a cleaning product will not be fixed free of charge, even if the appliance is within the guarantee period.
- Do not use cleaning products containing abrasive materials for the cleaning and maintenance of the glass front panel.

Replacement of the oven light bulb

In order to avoid the possibility of an electric shock ensure that the appliance is switched off before replacing the bulb.

- Set all control knobs to the position "0" and disconnect the mains plug, unscrew and wash the lamp cover and then wipe it dry.
- Unscrew the light bulb from the socket, replace the bulb with a new one—a high temperature bulb (300°C) with the following parameters:
 - voltage 230V
 - power 25W
 - thread G9.
- Do not use any other type of bulb.
- Screw the bulb in, making sure it is properly inserted into the ceramic socket.
- Screw in the lamp cover.

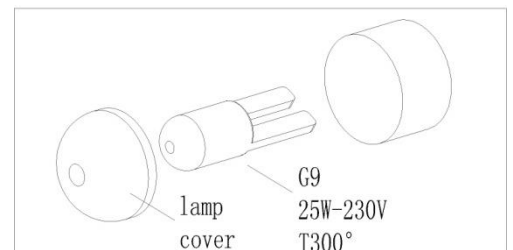

Remove the door

- Full open the door.
- Fold up the right and left side of locking rod. (picture A)

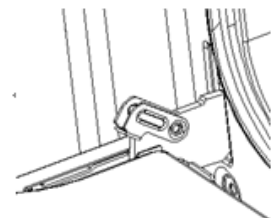

A

- Close the door until reach to stop step, hold on both left and right sides of the door, then reclose the door, upward and downward and pull out the door.

Install the oven door

Accord to the opposite order of door disassembly

- When install oven door, make sure both hinge plug into opening mouth directly.
- Both sides of hinge rabbet must bite up each other.
- When open the door, spread down locking rod (picture B)

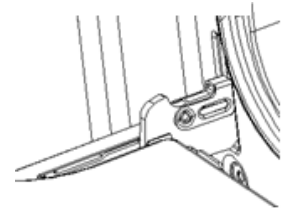

B



If the door drop accidentally or hinges shut up suddenly, do not push you hand in hinges. Please call your after-sell department.

Removal of the internal glass panel

Unscrew and unfasten the bracket latch that is in the corner at the top of the door. Next take out the glass from the second blocking mechanism and remove. After cleaning, insert and block the glass panel, and screw in the blocking mechanism. As shown picture C.

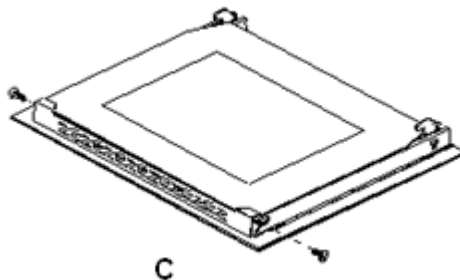

C

Regular inspections

Besides keeping the cooker clean, you should:

1. Carry out periodic inspections of the control elements and cooking units of the cooker. After the guarantee has expired you should have a technical inspection of the cooker carried out at a service centre at least once every two years.
2. Fix any operational faults

Carry out periodical maintenance of the cooking units of the cooker.



Caution!

All repairs and regulatory activities should be carried out by the appropriate service centre or by an appropriately authorized fitter.

Environmental note

Note: Before discarding an old appliance, switch off and disconnect it from the power supply. Cut off and render any plug useless. Cut the cable off directly behind the appliance to prevent misuse. This should be undertaken by a competent person.

This appliance is marked according to the European directive 2002/96/EC on Waste electrical and Electronic Equipment (WEEE). By ensuring this product is disposed of correctly, you will help prevent potential negative consequences for the environment and human health, which could otherwise be caused by inappropriate waste handling of this product.



The symbol  on the product or on the documents accompanying the product

indicates that this appliance may not be treated as household waste. Instead it shall be handed over to the applicable collection point for the recycling of electrical and electronic equipment.

Disposal must be carried out in accordance with local environmental regulations for waste disposal. For more detailed information about treatment, recovery and recycling of this product, please contact your local city office or local waste management office.

The packaging materials that we use are environmentally friendly and can be recycled. Please discard all packaging material with due regard for the environment.



Transportation

Keep the original carton of the product and use this packaging if the item needs to be transported.

Follow the transport signs on the carton.

Tape cardboard or paper onto the inside face of the glass as it will be prone to damage from the trays. Use cardboard covers for the wire grill and trays in your oven. Also tape the oven's covers to the side walls.

If the original carton is unavailable, take measures to protect the external surfaces (glass and painted surfaces) of oven against possible blows, as well as the above.