

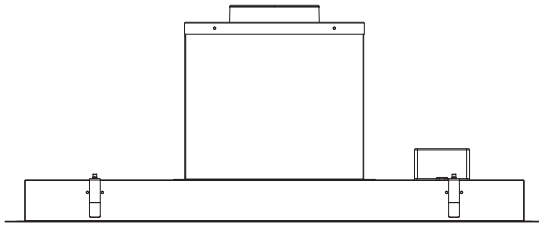



## EN INSTRUCTIONS FOR USE



[01] x 1

# Let's get started...

	<b>Getting started...</b>	<b>03</b>
	<b>Safety</b>	04
	<b>Checking instructions</b>	08
	<b>In more detail...</b>	<b>10</b>
	<b>Use</b>	10
	<b>Care and maintenance</b>	11
	<b>Trouble shooting</b>	12
	<b>Direct Connection</b>	13
	<b>Recycling and disposal</b>	14
	<b>Technical data</b>	15
	<b>Appendix...</b>	
	<b>Installation</b>	17

## Safety

**These instructions are for your safety. Please read the following instructions carefully before proceeding with the installation and use of this appliance.**

- ✓ This appliance must be installed correctly by a qualified person, strictly following the manufacturer's instructions.
- ✓ **WARNING:** Danger of electric shock! The power supply must be cut off before the appliance is installed completely.
- ✓ **WARNING:** There is a risk of electric shock and fire if cleaning is not carried out in accordance with these instructions.
- ✓ **WARNING:** Where applicable, this appliance is supplied with fixings. Please ensure you use the correct fixings suitable for the substrate where the appliance will be installed and that they are able to support the weight of the appliance.
- ✓ **WARNING:** Use only the same size of fittings and mounting screws as recommended in this instruction manual. Failure to follow these instructions may result in electrical hazards.
- ✓ **WARNING:** Switch off the appliance at the mains supply before carrying out any maintenance work or cleaning.
- ✓ **WARNING:** Accessible parts may become hot when used with cooking appliances. Young children should be kept away. Care should be taken to avoid touching the appliance.
- ✓ **WARNING:** Do not flame under the hood. To avoid the risk of fire, clean or replace the grease filter regularly and closely monitor pans containing hot oil.

- ✓ **WARNING:** Means for full disconnection must be incorporated in the fixed wiring in accordance with the local wiring installation rules for your country. An all-pole disconnection switch having a contact separation of at least 3mm in all poles should be connected during installation.
- ✓ **WARNING:** Before connecting the hood, check that the supplied voltage and frequency match with that indicated on the appliance rating plate. Failure to install the appliance in accordance with these instructions may result in a safety hazard. If in doubt, ask for advice instore or from a qualified installer.
- ✓ **WARNING:** Consult local regulations regarding extraction outlets and ensure these are complied with. Do not connect the hood to a ventilation or hot air duct containing combustion fumes from burning gas or other fuels. Confirm that room ventilation is appropriate with the local authorities.
- ✓ **WARNING:** The hood may stop working during an electrostatic discharge (e.g. lightning). This involves no risk of damage. Switch off the electricity supply to the hood and reconnect after one minute.
- ✓ **WARNING:** This appliance can be used by children aged from 8 years and above and persons with reduced physical, sensory or mental capabilities or lack of experience and knowledge if they have been given supervision or instruction concerning use of the appliance in a safe way and understand the hazards involved. Children shall not play with the appliance. Cleaning and user maintenance shall not be made by children without supervision. Keep the appliance and its supply cord out of the reach of children less than 8 years old.

## Safety

- If the supply cord is damaged, it must be replaced by the manufacturer, its service agent or similarly qualified persons in order to avoid a safety hazard.
- Do not install the appliance outdoors in a damp place or in an area which may be prone to water leaks such as under or near a sink unit. In the event of a water leak affecting the appliance, do not use and contact customer services to arrange for inspection.
- Do not use flammable sprays in close vicinity to the appliance.
- Please dispose of the packing material carefully. There is a fire risk if cleaning is not carried out in accordance with the instructions. Refer to the Care and Maintenance sections carefully for details on how to clean and replace the aluminium and carbon filters (if fitted).
- Refer to the Care and Maintenance section for details on the type of lamps that can be used and how to replace them.
- Do not use a steam cleaner for care and maintenance.
- The appliance is not intended to be operated by means of an external timer or separate remote control system.
- There shall be adequate ventilation of the room when the hood is used at the same time as appliances burning gas or other fuels. Ensure that the negative pressure of the installation site does not exceed 4 Pa (0.04 mbar) to ensure combustion fumes are not drawn back into the room.
- Do not use the hood if it shows signs of damage or imperfection. Contact customer services for assistance.

- ✓ The manufacturer declines all liability for personal or material damage as a result of misuse or incorrect installation of this appliance.
- ✓ The appliance is for domestic use only as an extractor hood.
- ✓ When installing the appliance, make sure that the following distances between the top of cooker or hob and the lowest part of the cooker hood must be observed:
  - > Gas hobs: 750mm.
  - > Electric hobs: 650mm.
- ✓ **Important:** If the room contains a fuel burning appliance, such as a gas, or oil fired, central heating boiler, which is not of the 'Balanced Flue' type, you should make sure that there is adequate air inlet into the room at all times so that fumes from the boiler are not drawn back into the room by the Cooker Hood.

## Checking instructions

### Things to check before you start

- To avoid the risks that are always present when you use an electrical appliance it is important that this cooker hood is installed correctly and that you read the safety instructions carefully to avoid misuse and hazards. We recommend that you keep this instruction booklet for future reference and pass it on to any future owners. After unpacking the cooker hood please check that it is not damaged. If in doubt, do not use the appliance but contact Customer Services on 0344 800 1128 (UK) and 01 4475261 (Ireland).
- Check the package and make sure you have all of the parts listed.
- Decide on the appropriate location for your product.
- If this product contains glass please take care with fitting or handing to prevent personal injury or damage to the product.
- This specifications plate is available on this appliance. This plate displays all the necessary identification information for ordering replacement parts.
- If you sell the appliance, give it away, or leave it behind when you move house, make sure you also pass on this manual so that the new owner can become familiar with the appliance and its safety warnings.

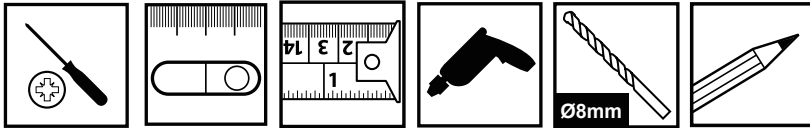



## Accessories not supplied

---

### Recirculation

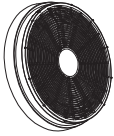

**SCF1 (UK & IE)**



**SELF ADHESIVE  
ALUMINIUM TAPE**

### Ducted

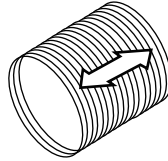

**Ø150mm  
VENT PACK**

**CARBON FILTER ORDERING  
HOTLINE**

**0344 800 1128 (UK)  
014475261 (IE)**

## Use

### Before you start









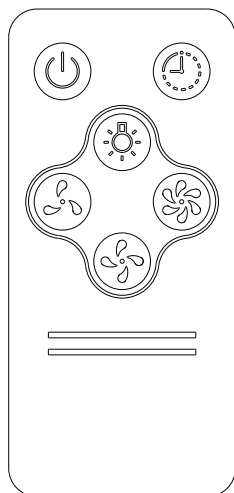
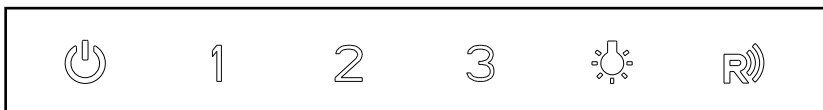

**WARNING:** Read the instructions before using the appliance.

Switch on the appliance at the switched fused connection unit. The appliance is ready for use.

### Function & Settings

#### Touch control panel & Remote control



		Power on/off. Only for control panel: When extractor fan is working, touch it to run the delay function for 3 minutes. After time out the extractor will be closed.
1		Extractor fan speed 1 button.
2		Extractor fan speed 2 button.
3		Extractor fan speed 3 button.
		Lighting on/off.
		Delay function. The extractor fan will run 3 minutes, until the fan turn off.
		Remote control receiver.

To obtain the best results from your cooker hood it is recommended that you leave it switched on for 15 minutes after you have finished cooking.



**WARNING:** Always switch off the electricity supply before carrying out maintenance work on the hood. In the event of a fault, contact customer services.

## Carbon filter replacement

Replace carbon filters every three months.



3 MONTHS

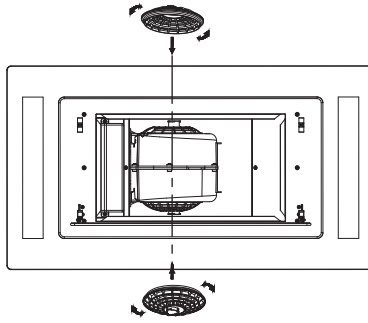

2 X CARBON FILTER.  
 MODEL NUMBER **SCF1** (UK & IE)  
 CARBON FILTER ORDERING HOTLINE  
 0344 800 1128 (UK)  
 014475261 (IE)

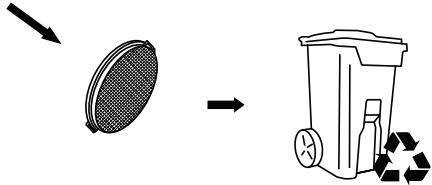

## Aluminium grease filters cleaning

To avoid fires, clean thoroughly once a month. To do so, remove the filters and soak in hot water and detergent for an hour. If using a dishwasher, position the filters vertically to improve the cleaning process.



1 MONTHS

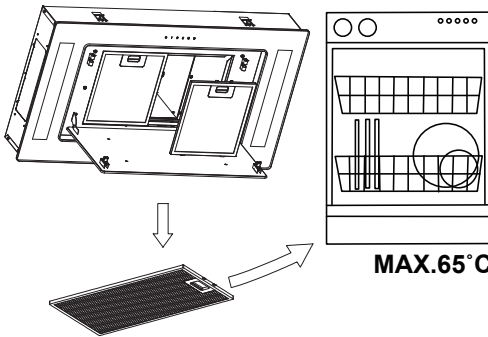

**WARNING:** Increase the filter cleaning/replacement frequency if the hood is used for more than 2 hours a day. Always use genuine filters from the manufacturer.

## Trouble shooting

### Trouble shooting

Problem	Possible cause	Solution
Excessive vibration.	The appliance is not installed properly on the brackets.	Take down the appliance and check it is properly fixed.
	The fan blade is damaged.	Switch off the appliance. Repair to be carried out by qualified service personnel only.
	The fan motor is not fixed tightly.	
The light is on, but the fan does not work.	The fan blade is jammed.	
	The motor is damaged.	
Both the light and motor do not work.	Light bulb blown.	Contact Customer Services on.
	Power connection loose.	Check power supply.
Suction performance reduced.	Speed may be too low.	Select a higher speed.
	Aluminium filters are dirty.	Clean the aluminium filters. (See Care and maintenance section).
	Top vent might be obstructed.	Clear any obstruction.
	Optional vent kit might be twisted.	Ensure that the vent kit is fitted according to the manufacturer's instructions.
	The installation may not comply with the manufacturers instructions.	The vent hose should be correct diameter throughout with no reductions or restriction.(See installation section).
Works normally but cooking smells linger.	Carbon filter is not fitted in recirculation mode or is full of grease.	Fit carbon filter or replace the carbon filter (See Care and maintenance section).
The hood does not work.	Check that the hood is connected to power. Check that the fuses or automatic have not jumped.	
The hood still does not work.	If, after having checked the points mentioned above, your problem has not yet been solved, contact the technical service or your distributor.	



**NOTE:** If the lamp fails please contact the after-sales care.

## Direct Connection

All installation must be carried out by a competent person or qualified electrician. Before connecting the mains supply ensure that the mains voltage corresponds to the voltage on the rating plate.

The appliance must be connected directly to the mains using an omnipolar circuit breaker with a minimum opening of 3mm between the contacts.

The installer must ensure that the correct electrical connection has been made and that it complies with the wiring diagram.

The cable must not be bent or compressed.

Regularly check the power plug and power cord for damage. If the supply cord is damaged, it must be replaced by a special cord or assembly available from the manufacturer or its service agent.

### **WARNING: This is a Class I appliance and MUST be earthed**

This appliance is supplied with a 3 core mains cable coloured as follows:

**Brown = L or Live**

**Blue = N or Neutral**

**Green and Yellow = E or Earth** 

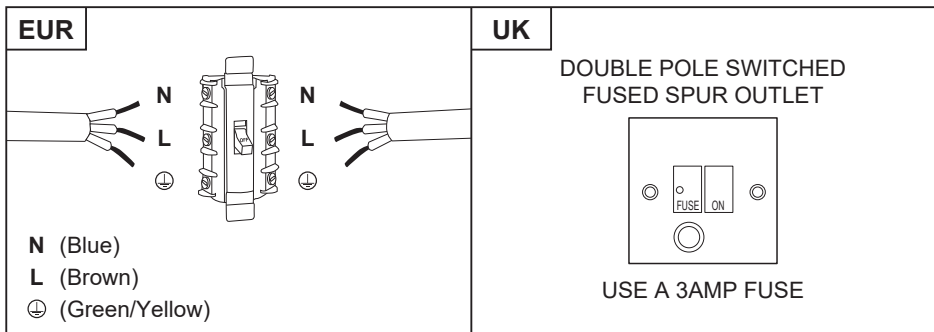

**The fuse must be rated at 3 Amps.**

To avoid the risks that are always present when you use an electrical appliance it is important that this appliance is installed correctly and that you read the safety instructions carefully to avoid misuse and hazards. Please keep this instruction booklet for future reference and pass it on to any future owners. After unpacking the appliance please check that it is not damaged. If in doubt, do not use the appliance but contact Customer Services.

### Direct Connection

---

The manufacturer declines all liability for damage caused to persons and objects due to incorrect or improper installation of the appliance. Any permanent electrical installation must comply with the latest wiring regulations applicable to your country and for your own safety a qualified electrician or contractor should undertake the electrical installation.

### Recycling and disposal

---

Waste electrical products (WEEE) should not be disposed of with household waste.

Please recycle where facilities exist. Check with your local governmental authority, domestic waste disposal services or the retailer where the product was bought for recycling advice.

The wheellie bin symbol on the product or its packaging indicates that this product cannot be treated as normal household waste. This product must be handed over to an electric and electronic equipment collection point for recycling. On ensuring that this product is disposed of correctly, you will help to avoid possible negative consequences for the environment and public health, which could occur if this product is not handled correctly.



Supply voltage	220-240V~, 50Hz
Power consumption - Fan	230W
Power consumption - Luminary	2 x 5W Max
Power consumption - Total	240W
Protection class	I
Light bulb	Max. 5W (LED strip)

## Information for EU No. 66/2014 and No. 65/2014

### A. Information of the cooker hood

	Symbol	Value	Unit
Model Identification	UBSDCH901W / UBSDCH902BK		
Annual Energy Consumption	AEC <sub>hood</sub>	42.1	KWh/a
Time increase factor	f	0.9	
Fluid Dynamic Efficiency	FDE <sub>hood</sub>	30.3	
Energy Efficiency Index	EEI <sub>hood</sub>	53.3	
Measured air flow rate at best efficiency point	Q <sub>BEP</sub>	259.6	M <sup>3</sup> /h
Measured air pressure at best efficiency point	P <sub>BEP</sub>	445	PA
Maximum air flow	Q <sub>MAX</sub>	618.8	M <sup>3</sup> /h
Air flow in normal use		Highest setting: 609.1 Lowest setting: 314	M <sup>3</sup> /h
Measured electric power input at best efficiency point	W <sub>BEP</sub>	105.9	W
Nominal power of the lighting system	W <sub>L</sub>	10.0	W
Average illumination of the lighting system on the cooking surface	E <sub>middle</sub>	70	lux
Lighting Efficiency	LE <sub>hood</sub>	7.0	lux/watt
Measured power consumption in standby mode	P <sub>s</sub>	-	W
Measured power consumption off mode	P <sub>o</sub>	0.42	W
Sound power level	L <sub>WA</sub>	Max.68 / Min.57	dB
Grease Filtering Efficiency	GFE <sub>hood</sub>	66.5	%

## Technical data

The measurement and calculation method of the above table was done in accordance with Commission Delegated Regulation (EU) No 65/2014 & Commission Regulation (EU) No 66/2014.

### **B. The following shows how to reduce total environmental impact (e.g. energy use) of the cooking process.**

1. Install the cooker hood in a proper place where there is efficient ventilation.
2. Clean the cooker hood regularly so as not to block the airway.
3. Remember to switch off the cooker hood light after cooking.
4. Remember to switch off the cooker hood after cooking.

### **C. Information for dismantling.**

This appliance cannot be dismantled by the user, other than that as shown in the original assembly of the user manual.

At the end of its useful life, the appliance should not be disposed of with household waste. Check with your local governmental authority, domestic waste disposal services or the retailer where the product was bought for recycling advice.



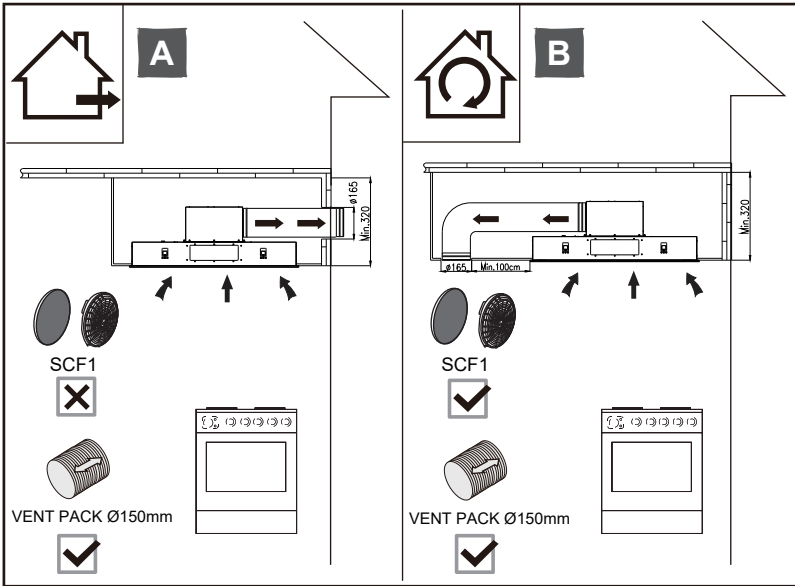

- EN Choose a type of installation:  
 A - Ducted option; B - Recirculation option

**WARNING:** Beware of any sharp edge of metal plates, wear suitable protective gloves when handling the product.

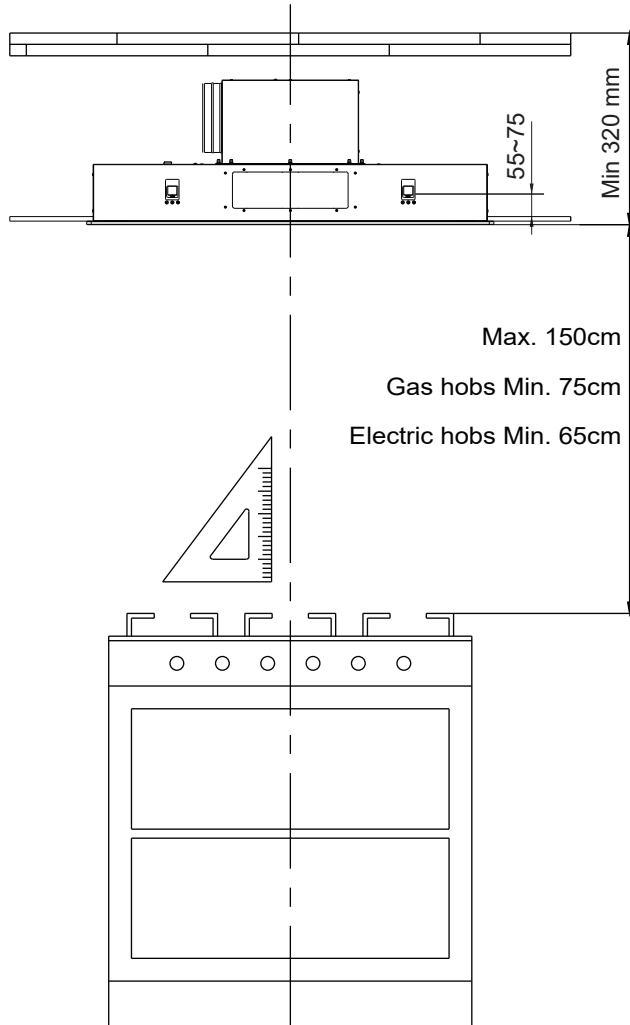

Before drilling it is extremely important to check the ceiling for hidden pipes, electrical cables etc. Ensure the cooker hood should be placed at a distance as shown above.

**WARNING: Caution!** This appliance is heavy. Before mounting the cooker hood ensure that the ceiling is capable of supporting the weight of the appliance. The ceiling may need to be strengthened to enable it to support the weight. If in doubt please seek the advice of a structural engineer.

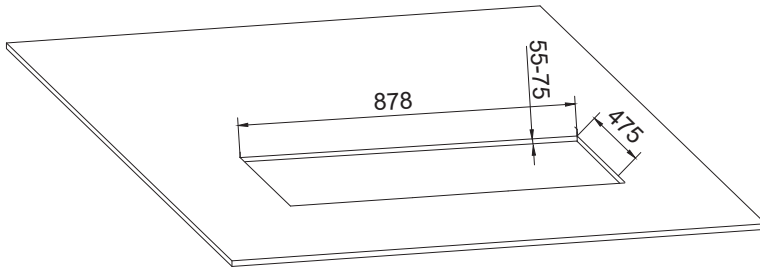

EN Open the hole according to the size required as shown in picture.

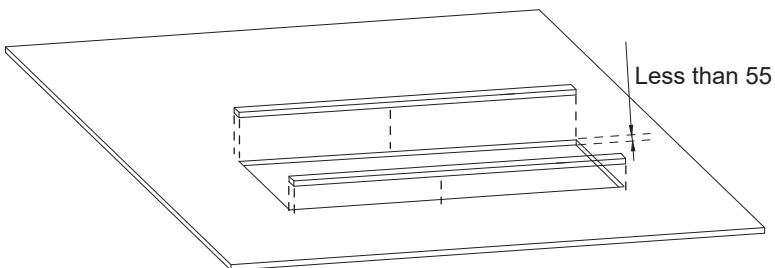

EN If the ceiling thickness is less than 55mm, need to reinforce the long side inside of ceiling by batten or stainless steel plate making the ceiling thickness within 55-70mm.

# 05

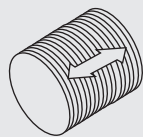

Ø150mm

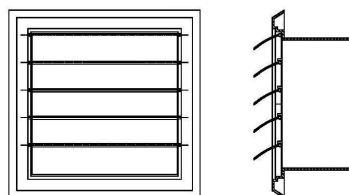
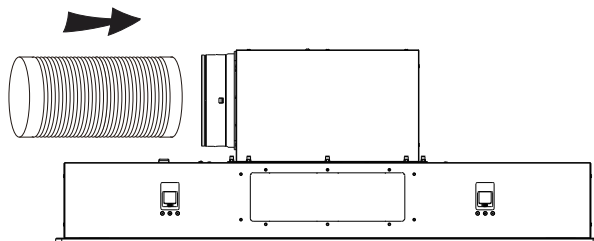

- EN Install the vent pack using cable ties. Ensure the external vent outlet has some form of backdraft shutter i.e. gravity flaps to prevent air blowing back into the room.

# 06

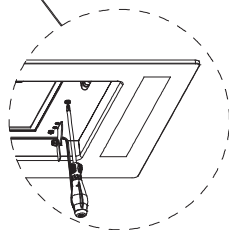
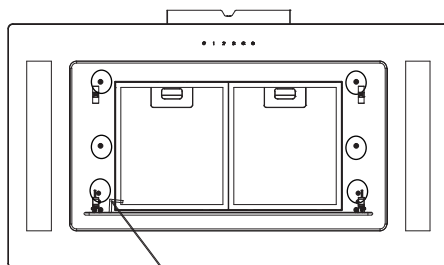

- EN Open the guide plate, take out the filter net and take off 6 pcs screws, take out guide plate and pluck and wire connected with switch and LED light.

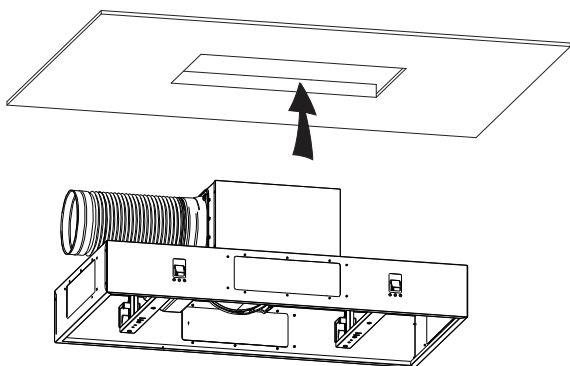

**EN** This appliance is heavy, fit it into ceiling by more than two peoples.

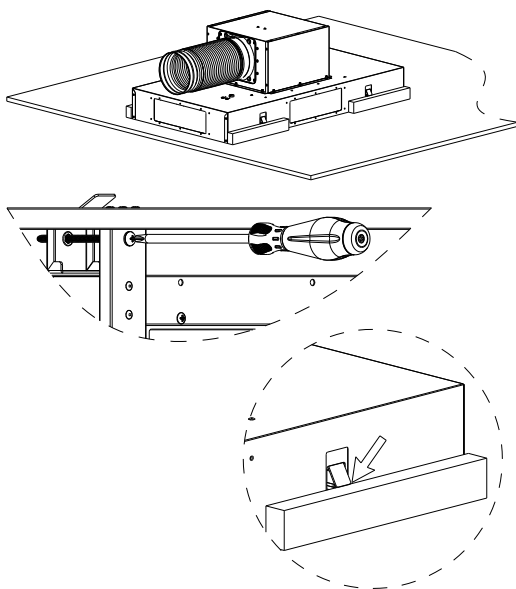

**EN** Adjust the screw of 4 bayonets until the hood body is aligned with the ceiling, make sure 4 bayonets to get stuck the wood frame installed inside of ceiling at same time, and make sure not loose from all sides.

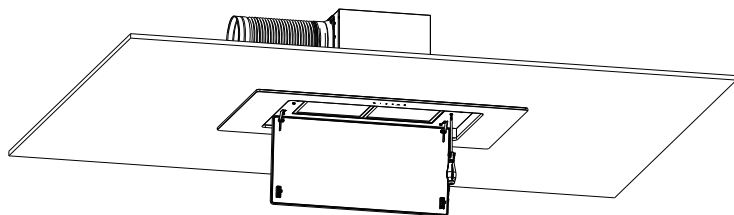

- EN** Fit guide panel to the body of hood, connect wire of switch and LED light, then fix 6 screws tightly.



---

**Apelson Appliances UK Ltd  
Unit 3 Normandy Landings  
Pope Street  
Castleford  
WF6 2AG**

---