

USER MANUAL

DOWN-DRAFT HOOD

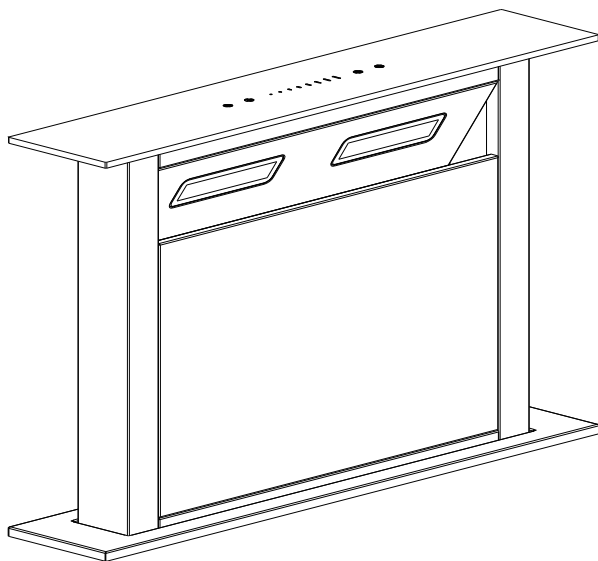

UBDDGS60ABK, UBDDGS60AWH, UBDDGS90ABK, UBDDGS90AWH Version 01

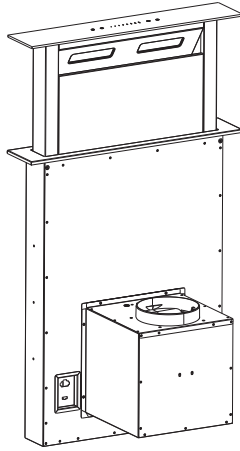

[01] x 1

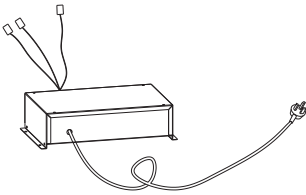

[02] x 1

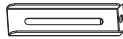

[03] x 2

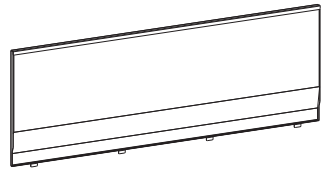

[04] x 1

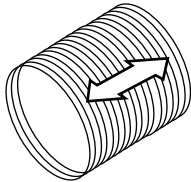

[08] x 1

VENT PACK 150mm



[09] x 1

[05] x 4
(4 x 8mm)

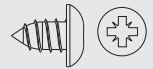

[06] x 8
(4 x 10mm)

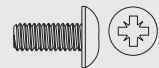

[07] x 8
(4 x 14mm)



Let's get started...

These instructions are for your safety. Please read through them thoroughly before use and retain them for future reference.



Getting **started**...

03

Safety

04

Before you start

08



In more **detail**...

10

Product functions

10

Switching on/off

10

Care and maintenance

11

Troubleshooting

13

Recycling and disposal

14

Technical and legal information

15



Appendix

Installation

17

Information for EU66

21

Safety

These instructions are for your safety. Please read through them thoroughly prior to installation and retain them for future reference.

Warning : For use with Gas Hobs and for the user not to touch the front panel due to heat



- All installation work must be carried out by a competent person or qualified electrician.
- This appliance must be installed correctly by a suitably qualified person, strictly following the manufacturer's instructions.

- This appliance complies with all current European safety legislation, however, the Manufacturer must emphasise that this compliance does not prevent the surfaces of the appliance from heating up during use and remaining hot during its operation.
- Accessible parts may become hot during use. Young children should be kept away. Care should be taken to avoid touching the appliance.
- The Manufacturer highly recommends that this appliance be kept out of the reach of babies and small children.
- This appliance can be used by children aged from 8 years and above and persons with reduced physical, sensory or mental capabilities or lack of experience and knowledge if they have been given supervision or instruction concerning use of

the appliance in a safe way and understand the hazards involved. Children shall not play with the appliance. Cleaning and user maintenance shall not be made by children unless they are older than 8 and supervised.

- ✓ Keep the appliance and its cord out of reach of children less than 8 years.
- ✓ Means for disconnection must be incorporated in the fixed wiring in accordance with the wiring rules. An all-pole disconnection switch having a contact separation of at least 3mm in all poles should be connected in fixed wiring.
- ✓ Regularly check the power plug and power cord for damage. If the supply cord is damaged, it must be replaced by the manufacturer, its service agent or similarly qualified persons in order to avoid a danger or injury.
- ✓ Do not allow the electric cables to touch the hot parts of the appliance.
- ✓ Make sure that the power cord is not caught under or in the appliance and avoid damage to the power cable.
- ✓ Do not install the appliance outdoors in a damp place or in an area which may be prone to water leaks such as under or near a sink unit. In the event of a water leak allow the machine to dry naturally.
- ✓ **Warning:** Failure to install the screws or fixing device in accordance with these instructions may result in electrical hazards.

Safety

- ✓ **Warning:** When the range hood and appliances supplied with energy other than electricity are simultaneously in operation, the negative pressure in the room must not exceed 4 Pa (4×10^{-5} bar).
- ✓ Please dispose of the packing material carefully.
- ✓ Do not use flammable sprays in close vicinity to the appliance.
- ✓ We also recommend that great care be taken during use and cleaning. Read the cleaning and maintenance sections for this appliance carefully.
- ✓ A steam cleaner is not to be used.
- ✓ The appliance is not intended to be operated by means of external timer or separated remote-control system.
- ✓ The appliance is for domestic use only.
- ✓ **Warning:** Consult local regulations regarding fumes outlets. Do not connect the hood to a fume, ventilation or hot air duct. Confirm that room ventilation is appropriate with the local authorities. Make sure the maximum air extraction flow rate for the appliances in the room does not exceed 4 Pa (0.04 mbar). The room must have adequate ventilation if an extractor hood is used simultaneously with appliances that run on gas or other fuels. The air must not be discharged into a flue that is used for exhausting fumes from appliances burning gas or other fuels. Regulations regarding air extraction must be complied with.
- ✓ **Warning:** Before connecting the hood: switch off the electricity supply and check that the supplied

voltage and frequency coincide with that indicated on the appliance nameplate.

- ✓ Warning: The hood may stop working during an electrostatic discharge (e.g. lightning). This involves no risk of damage. Switch off the electricity supply to the hood and reconnect after one minute.
- ✓ To avoid the risk of fire, clean the metal filter regularly and closely watch and regulate pans containing hot oil.
- ✓ Do not use the hood if it shows signs of damage or imperfection. Contact customer services.
- ✓ Flambe cooking must not be carried out in front of this appliance.
- ✓ The Manufacturer declines all liability for personal or material damage as a result of misuse or incorrect installation of this appliance.
- ✓ Regarding the information pertaining to installation, thanks to refer to the below paragraph of the manual.
- ✓ Regarding the information for replacing the bulb, please see section "Care and maintenance".
- ✓ Regarding the instructions for the lamp replacement, thanks to refer to the section "LAMP REPLACEMENT".
ILCOS D code for this lamp is: DBS-1-S.



Warning

There is a risk of electric shock and fire if cleaning is not carried out in accordance with the instructions.

Before you start

Things to check before you start

- To avoid the risks that are always present when you use an electrical appliance it is important that this cooker hood is installed correctly and that you read the safety instructions carefully to avoid misuse and hazards. We recommend that you keep this instruction booklet for future reference and pass it on to any future owners. After unpacking the cooker hood please check that it is not damaged. If in doubt, do not use the appliance but contact Customer Services on 0344 800 1128 (UK) and 01 4475261 (Ireland).
- Check the package and make sure you have all of the parts listed.
- Decide on the appropriate location for your product.
- If this product contains glass please take care with fitting or handling to prevent personal injury or damage to the product.
- This specifications plate is available on this appliance. This plate displays all the necessary identification information for ordering replacement parts.
- If you sell the appliance, give it away, or leave it behind when you move house, make sure you also pass on this manual so that the new owner can become familiar with the appliance and its safety warnings.

You will need

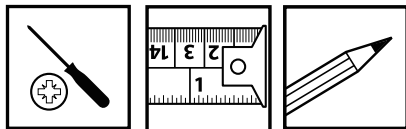

Accessories supplied

Recirculation

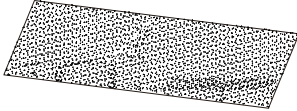

**ATFILT3 for 60cm product;
ATFILT4 for 90cm product.**



Steel fixed wire

CARBON FILTER ORDERING

HOTLINE

0344 800 1128 (UK)

014475261 (IE)

Operation

Product functions

- This appliance extracts the air of the kitchen to remove the odours and keep an optimum level of air quality inside the room, it also allows you to illuminate the cooking area.

Switching on/off

- Switch on the appliance at the switched fused connection unit. The appliance is ready for use.

Touch control panel

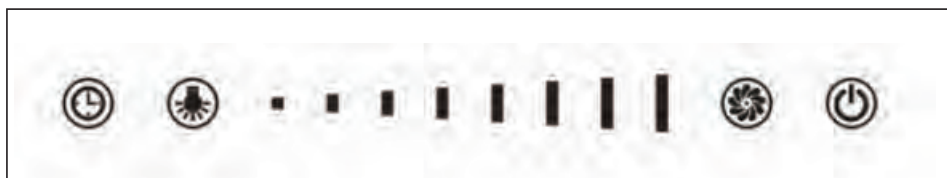

This panel is located on the front part of the hood and includes:



Extractor will operate at the current speed for setting time by “Slide control” button with 5-10-15-20-25-30-35-40 minutes. When time out, extractor and light will be closed.



On/off button of the light. Allows the light intensity to be regulated by “Slide control” button when the pilot light is flashing.



On/off button of the extractor fan. Can be choices 4 speed settings by “Slide control” button which per two lattices shall be corresponding a speed setting.



On/off button of the extractor. Press button for 2 seconds, the extraction outlet will lift or go down depending on the starting position.

- • • • • Used to control the light intensity, speed setting and timer.

To obtain the best results from your cooker hood it is recommended that you leave it switched on for 15 minutes after you have finished cooking.

Active charcoal filters replacement



Warning

Always switch off the electricity supply before carrying out maintenance work on the hood. In the event of a fault, contact customer services.

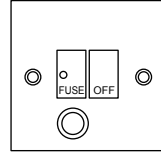

1

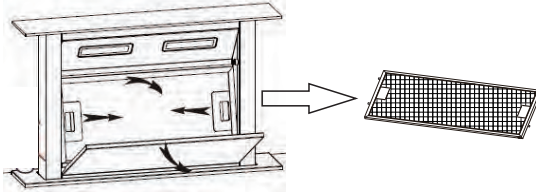

2

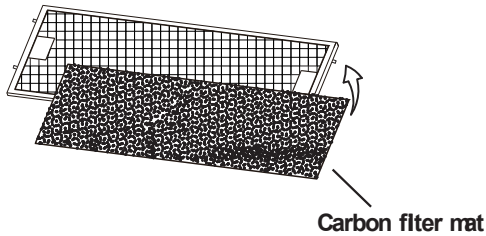

3

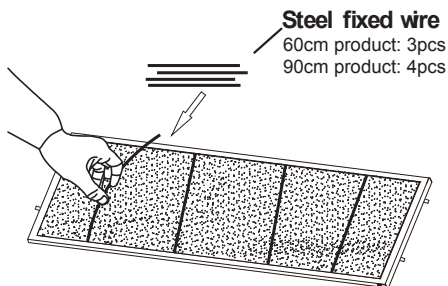

1 X ACTIVE CHARCOAL FILTER MAT (SUPPLIED).

MODEL NUMBER: ATFILT3 for 60cm product;

ATFILT4 for 90cm product.

CARBON FILTER ORDERING HOTLINE

0344 800 1128 (UK)

014475261 (IE)

Active charcoal filter replacement



1 MONTH

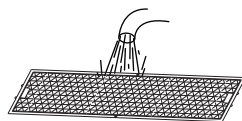
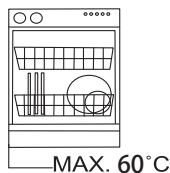
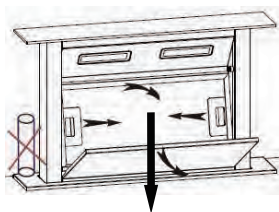

Aluminium filters: to avoid fires, clean thoroughly once a month. To do so, remove the filters and wash with hot water and detergent. If using a dishwasher position the filters vertically to improve the cleaning process.

Active charcoal filters:

Replace every 3 months.



3 MONTH

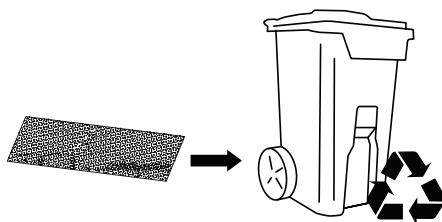
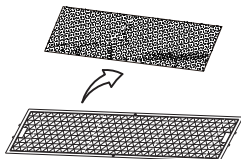
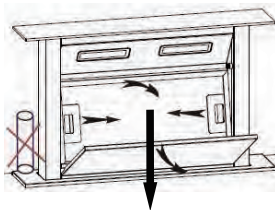

- Note: 1. Please do not put anything which can block the up & down of the hood to avoid the damage of the hood and body injury.
2. Please keep the power off when clean the hood.



Note: Increase the filter cleaning/replacement frequency if the hood is used for more than 2 hours a day. Always use genuine filters from the manufacturer.

Troubleshooting

Fault	Cause	Solution
Hood doesn't work.	No power supply.	Check the plug.
		Check the main switch.
Poor airflow	Aluminum grease filters are dirty.	Clean the filters. See <i>Care and maintenance</i> section.
Motor running, but no airflow	Butterfly valve jammed.	Repair to be carried out by qualified service personnel only.
After running for a while, motor stop working.	High temperature safety device activated.	Ensure that the vent kit is fitted to the manufactures instructions.
	Electric hobs: 30mm	Electric hobs: 30mm
Whirring sound.	Fan blade probelm.	Repair to be carried out by qualified service personnel only.
Oil leakage	One way valve and the air ventilation entrance are not tightly sealed.	Take down the one way valve and seal with glue.
	Leakage from the connection of U-shaped section and cover.	Take U-shaped section down and seal with soap or paint.
Shake of the body	The body is not tightly hanged.	Fixed the body tightly.
The machine inclines	The fixing screw not tight enough.	Tighten the hanging screw and make it horizontal.
	The hanging screw not tight enough.	Tighten the hanging screw and make it horizontal.



NOTE

If the lamp is failed please contact the after-sales care.

Recycling and disposal

Environmental protection

Waste electrical products should not be disposed of with household waste. Please recycle where facilities exist. Check with your Local Authority or retailer for recycling advice.



The symbol on the product or its packaging indicates that this product cannot be treated as normal household waste. This product must be handed over to an electric and electronic equipment collection point for recycling.

On ensuring that this product is disposed of correctly, you will help to avoid possible negative consequences for the environment and public health, which could occur if this product is not handled correctly. To receive more detailed information about recycling this product, contact your local government, domestic waste disposal services or the outlet where the product was bought.

Technical specification

Supply voltage	220-240V~, 50Hz
Power consumption - Fan	230W
Power consumption - Luminary	2 x 1W Max
Power consumption - Total	232W
Protection class	I
Light bulb	Max. 1W (LED Module)
ILCOS D code	DBS-1-S

Wiring

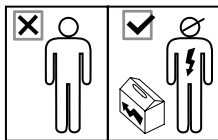

All installation work must be carried out by a competent person or qualified electrician.

Before connecting the mains supply ensure that the mains voltage corresponds to the voltage on the rating plate.



WARNING: THIS APPLIANCE MUST BE EARTHED.

Mains Supply could be connected to the Mains Voltage by Direct Connection

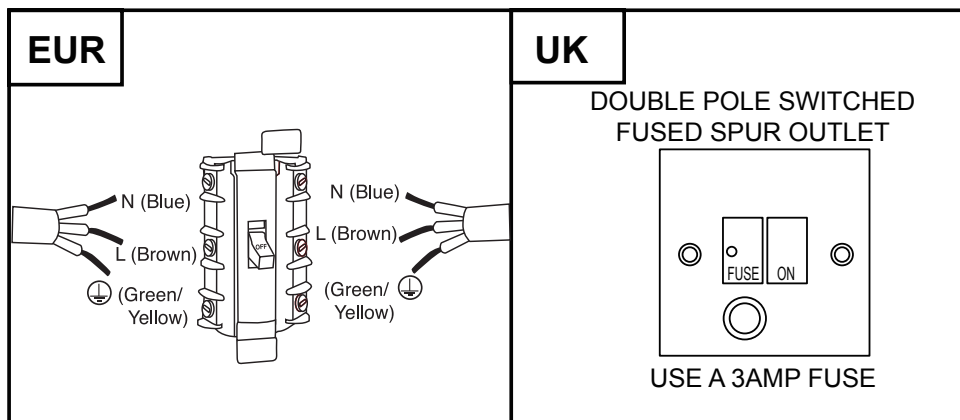

Direct Connection

If the appliance is being connected directly to the mains an omnipolar circuit-breaker must be installed with a minimum opening of 3mm between contacts.

The installer must ensure that the correct electrical connection has been made and that it complies with wiring diagram.

The cable must not be bent or compressed.

Regularly check the power plug and power cord for damage. If the supply cord is damaged, it must be replaced by a special cord or assembly available from the manufacturer or its service agent.

Technical and legal information

The Manufacturer declines all liability for damage caused to persons and objects due to incorrect or improper installation of the appliance.

Electrical Requirements

Any permanent electrical installation must comply with the latest I.E.E. regulations and local electricity company regulations. For your own safety a qualified electrician or contractor who is on the roll of the National Inspection Council for Electrical Installation Contracting (NICEIC) should undertake the electrical installation.

Electrical Connection

Before connecting the mains supply ensure that the mains voltage corresponds to the voltage on the rating plate inside the appliance.



WARNING: THIS APPLIANCE MUST BE EARTHED

The appliance is supplied with a 3-core mains cable and must be connected to the electricity supply via a double pole switch having a 3mm minimum contact gap on each connector.

For UK only

A Switched Fused Connection Unit to BS 1363 Part 4 is recommended.

The fuse must be rated at 3 Amps.

The wires in the mains lead are coloured in accordance with the following code:

Brown = L - Live

Blue = N - Neutral

Green/Yellow = ⊕ - Earth

The connection point must be placed in a position adjacent to the appliance so as to be readily accessible for an engineer in the event of a breakdown.

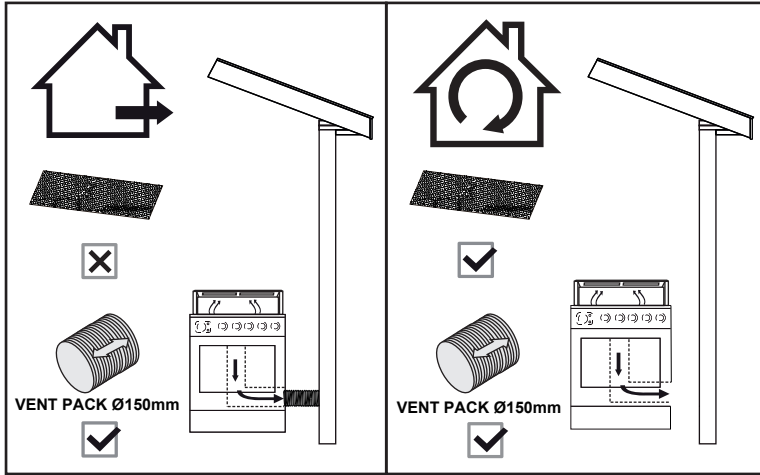

DUCTED OPTION

RECIRCULATION OPTION

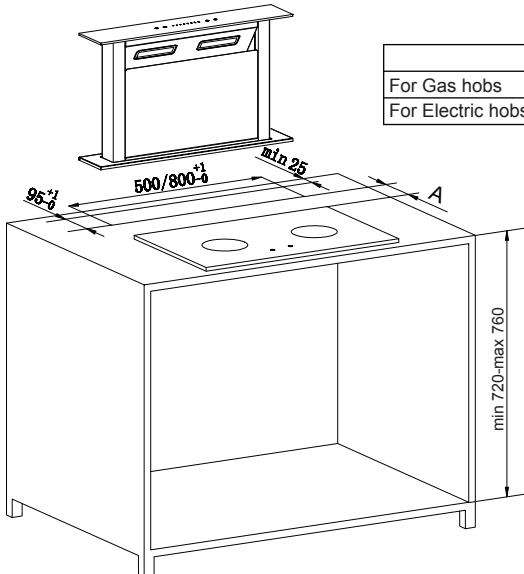

	A
For Gas hobs	65-80mm
For Electric hobs	>40mm

Mark and cut a hole in the worktop using the dimensions shown above.
(Unit: mm)

03

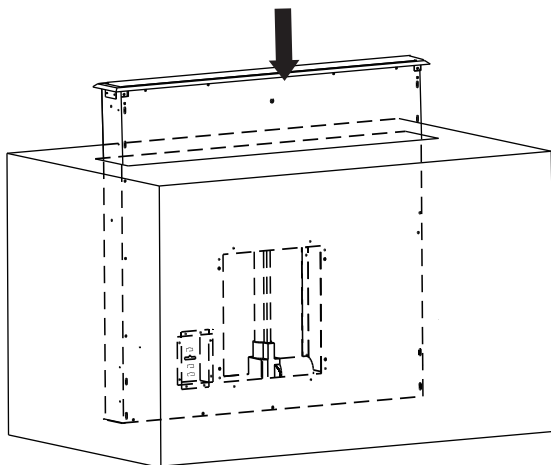

Put the hood into the hole of the cabinet slowly.

04



[05] x 2



[07] x 2



[03] x 2

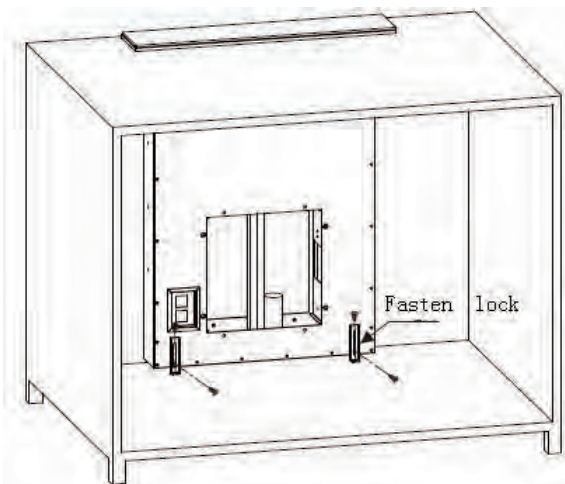

Use screws and fixing bracket to fix the hood.

For safety reason, please use only the same size of fixing or mounting screw which are recommended in this instruction manual.



Warning: Failure to install the screws or fixing device in accordance with these instructions may result in electrical hazards.

05

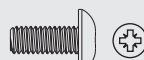
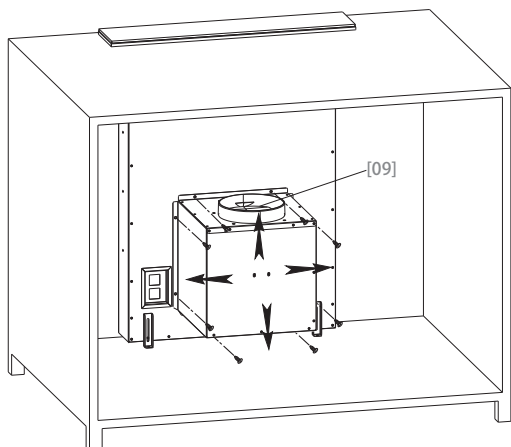

[06] x 8

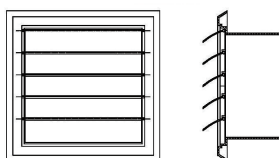

Connect the casing and hood. The wind direction are up, down, left, right, the user can select according to the space of the cabinet. Ensure the external vent outlet has some form of backdraft shutter i.e. gravity flaps to prevent air blowing back into the room.

06

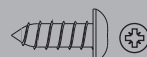
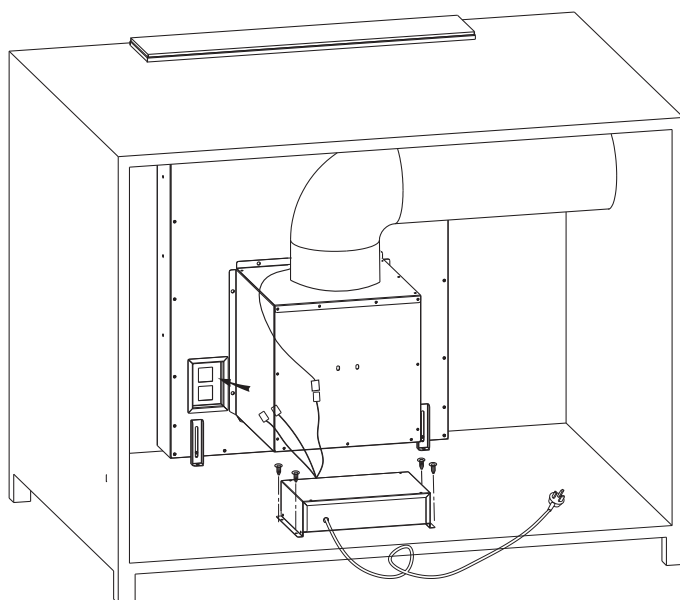

[07] x 4

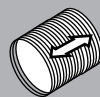

[08] x 1

VENT PACK Ø150mm



[10] x 1

Fix the vent pack on the outlet, and use 4pcs screws to fix the PCB box, connect the power.

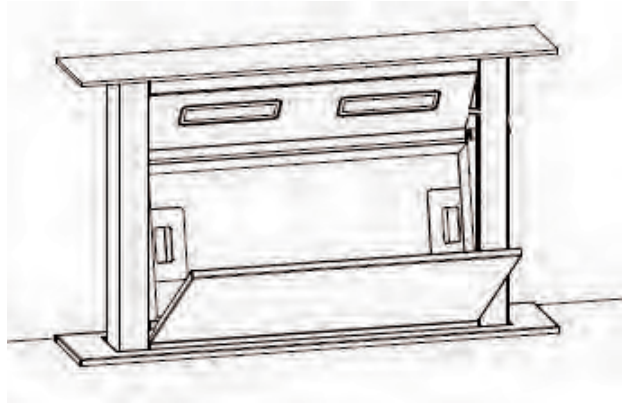

Plug in the cooker hood and fix the decorative glass.

For recirculating option refer to **Care and maintenance** section.

Note: For electrical connection see **Technical and legal information** section.

Note: Do not touch the decorative front glass panel during or after the operation of the hood to avoid burns.

**(A) Information of the cooker Hood**

	Symbol	Value	Unit
Model identification		UBDDGS60ABK UBDDGS60AWH	
Annual Energy Consumption	AEC_{hood}	52.4	kWh/a
Time increase factor	f	1.1	
Fluid Dynamic Efficiency	FDE_{hood}	26.0	
Energy Efficiency Index	EEl_{hood}	61.2	
Measured air flow rate at best efficiency point	Q_{BEP}	272.8	m ³ /h
Measured air pressure at best efficiency point	P_{BEP}	428	Pa
Maximum air flow	Q_{max}	579.7	m ³ /h
Measured electric power input at best efficiency point	W_{BEP}	124.7	W
Nominal power of the lighting system	W_L	3.2	W
Average illumination of the lighting system on the cooking surface	E_{middle}	69	lux
Measured power consumption in standby mode	P_s	-	W
Measured power consumption off mode	P_o	0.47	W
Sound power level	L_{WA}	Max. 72 / min. 58	dB
Lighting Efficiency	LE_{hood}	21.6	lux/W
Grease Filtering Efficiency	GFE_{hood}	51.8	%
Air flow at min. and max. speed in normal use		Max. 562.3 / min. 216.0	m ³ /h

The measurement and calculation method of the above table was done in accordance with commission regulation (EU) No 65/2014 & 66/2014.

B) The following shows how to reduce total environmental impact (e.g. energy use) of the cooking process.

- (1) Install the cooker hood in a proper place where there is efficient ventilation.
- (2) Clean the cooker hood regularly so as not to block the airway.
- (3) Remember to switch off the cooker hood light after cooking.
- (4) Remember to switch off the cooker hood after cooking.

(C) Information for dismantling.

Do not dismantle the appliance in a way which is not shown in the user manual. The appliance could not be dismantled by user. At the end of life, the appliance should not be disposed of with household waste. Check with you Local Authority or retainer for recycling advice.

**(A) Information of the cooker Hood**

	Symbol	Value	Unit
Model identification		UBDDGS90ABK UBDDGS90AWH	
Annual Energy Consumption	AEC_{hood}	48.2	kWh/a
Time increase factor	f	1.0	
Fluid Dynamic Efficiency	FDE_{hood}	28.0	
Energy Efficiency Index	EEI_{hood}	56.8	
Measured air flow rate at best efficiency point	Q_{BEP}	285.7	m ³ /h
Measured air pressure at best efficiency point	P_{BEP}	443	Pa
Maximum air flow	Q_{max}	605.0	m ³ /h
Measured electric power input at best efficiency point	W_{BEP}	125.6	W
Nominal power of the lighting system	W_L	3.2	W
Average illumination of the lighting system on the cooking surface	E_{middle}	66	lux
Measured power consumption in standby mode	P_s	-	W
Measured power consumption off mode	P_o	0.47	W
Sound power level	L_{WA}	Max. 73 / min. 52	dB
Lighting Efficiency	LE_{hood}	20.6	lux/W
Grease Filtering Efficiency	GFE_{hood}	51.8	%
Air flow at min. and max. speed in normal use		Max. 591.0 / min. 226.0	m ³ /h

The measurement and calculation method of the above table was done in accordance with commission regulation (EU) No 65/2014 & 66/2014.

B) The following shows how to reduce total environmental impact (e.g. energy use) of the cooking process.

- (1) Install the cooker hood in a proper place where there is efficient ventilation.
- (2) Clean the cooker hood regularly so as not to block the airway.
- (3) Remember to switch off the cooker hood light after cooking.
- (4) Remember to switch off the cooker hood after cooking.

(C) Information for dismantling.

Do not dismantle the appliance in a way which is not shown in the user manual. The appliance could not be dismantled by user. At the end of life, the appliance should not be disposed of with household waste. Check with you Local



Apelson Appliances UK Limited
Unit 3 Normandy Landings
Pope St
Castleford
WF6 2AG
