

User Manual

Instruction Manual

Induction Hob

MODEL:ICONTFT60

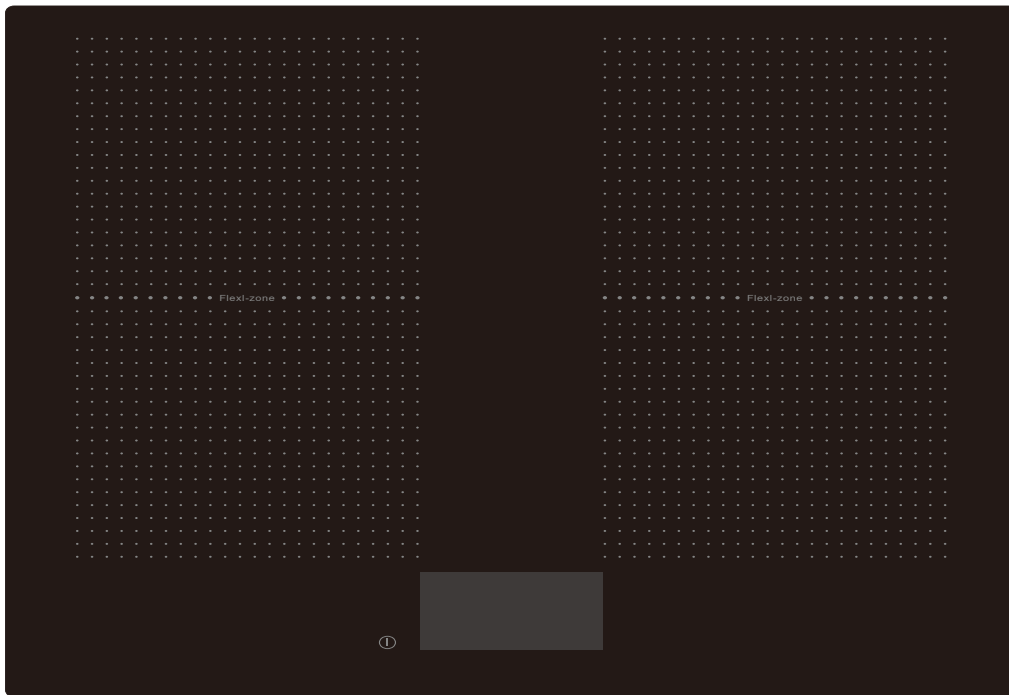

Preparation	03
Safty	04
Installation	05
Before you start	09
Use	10
Care and Maintenance	33
Electrical Installation	36
Technical Specification	37

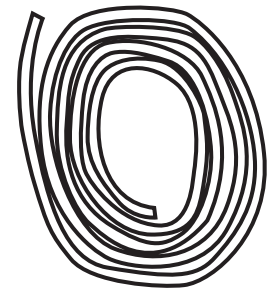
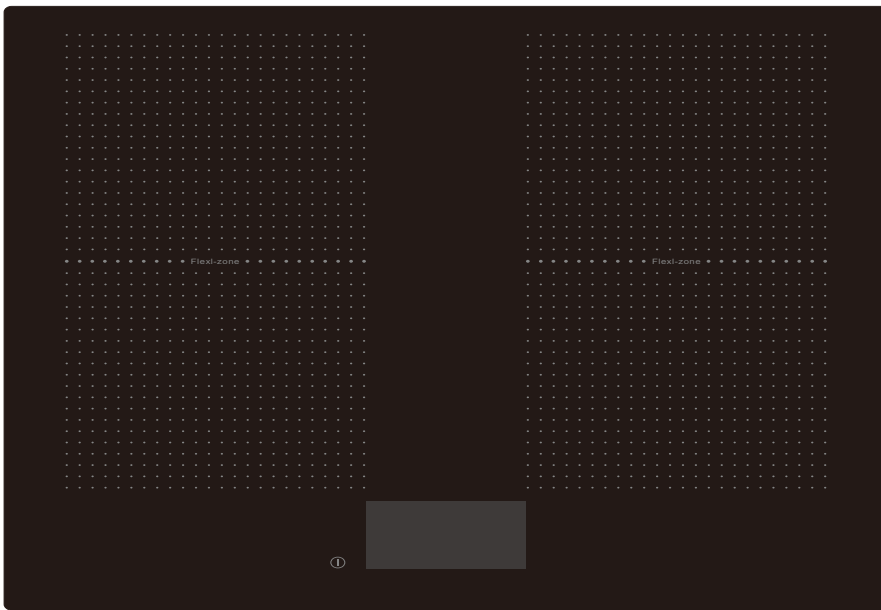
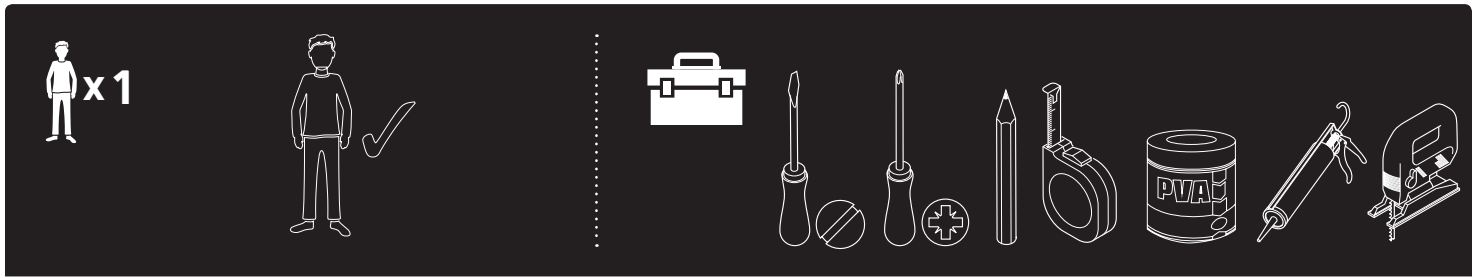

[02] x 1

Safety

Caution:

- The induction hotplate must be installed by qualified personnel or technicians. Please never conduct the operation by yourself.
- The hob must not be installed directly above a dishwasher, fridge, freezer, washing machine or clothes dryer, as the humidity may damage the hob electronics.
- This hob must not be installed directly above a kitchen drawer used to store cutlery or other metal items due to the proximity of its magnetic field.
- Do not attempt to dismantle the appliance, there are no user serviceable parts inside.
- At the end of its life, the appliance should not be disposed of in household waste; contact your Local Authority for guidance.

Caution:

- This hob must be connected to the mains power supply only by a suitably qualified person.
- Before connecting the hob to the mains power supply, check that:
 1. the domestic wiring system is suitable for the power drawn by the hob.
 2. the voltage corresponds to the value given in the rating plate.
 3. the power supply cable sections can withstand the load specified on the rating plate.
- To connect the hob to the mains power supply do not use adapters, reducers, or branching devices, as they can cause overheating and fire.
- The power supply cable must not touch any hot parts and must be positioned so that its temperature will not exceed 75°C at any point.
- The work surface is square and level, and no structural members interfere with space requirements.
- The work surface is made of a heat-resistant material.
- If the hob is installed above an oven, the oven has a built-in cooling fan.
- The installation will comply with all clearance requirements and applicable standards and regulations.
- A suitable isolating switch providing full disconnection from the mains power supply is incorporated in the permanent wiring, mounted and positioned to comply with the local wiring rules and regulations. The isolating switch must be of an approved type and provide a 3 mm air gap contact separation in all poles (or in all active [phase] conductors if the local wiring rules allow for this variation of the requirements).
- The isolating switch will be easily accessible to the customer with the hob installed.
- You consult local building authorities and by-laws if in doubt regarding installation.
- You use heat-resistant and easy-to-clean finishes (such as ceramic tiles) for the wall surfaces surrounding the hob.
- When you have installed the hob, make sure that:
 - The power supply cable is not accessible through cupboard doors or drawers.
 - There is adequate flow of fresh air from outside the cabinetry to the base of the hob.
- If the hob is installed above a drawer or cupboard
 - space, a thermal protection barrier is installed below the base of the hob.
 - The isolating switch is easily accessible by the customer. The hob should be fixed into the worktop
 - using the fixing brackets and sealing tape supplied with the appliance. Do not use silicone sealant or PVA to secure the hob. Doing so will prevent an engineer removing the appliance to facilitate a repair.

Installation

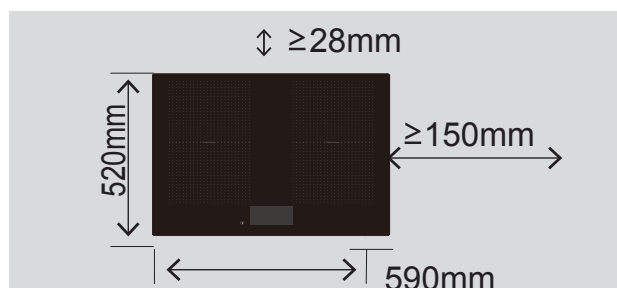
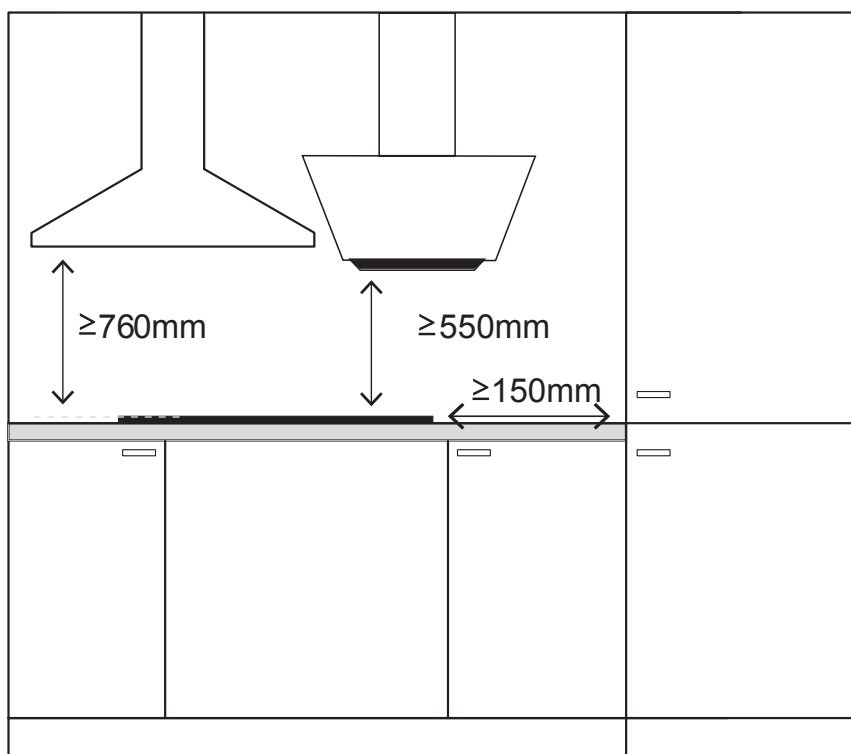

Caution! Before drilling it is extremely important to check the wall for hidden pipes, electrical cables etc using an appropriate detection device.

Warning: Good ventilation is required around the appliance for easier dissipation of heat and low power consumption. Sufficient clearance is required around the appliance. The safety distance for an angled glass hood should be at least 550mm between the hotplate and the lowest point where it is mounted on the wall.

Installation

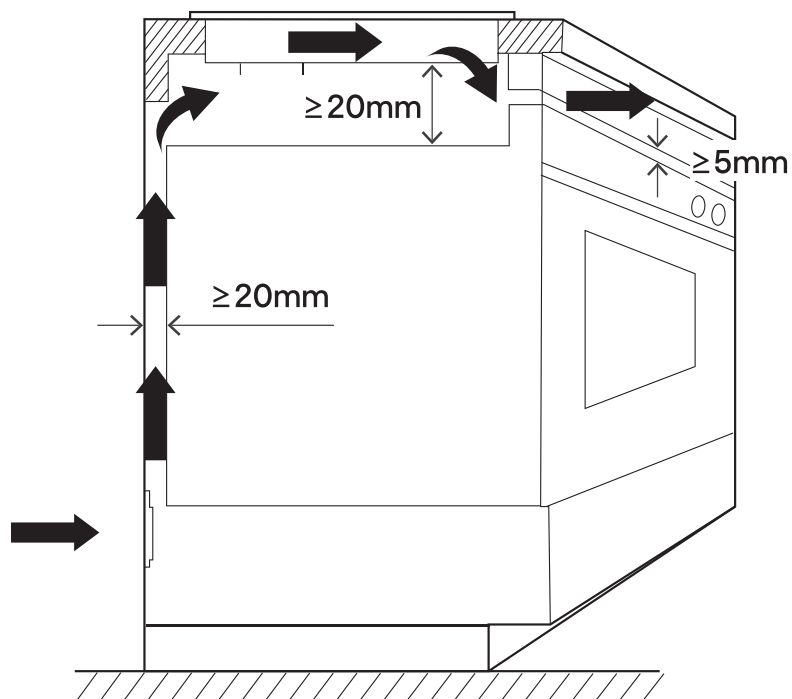

The induction hob must be well ventilated and the air inlet and outlet must not be blocked. Ensure you select a heat-resistant work surface to mount the induction hob.

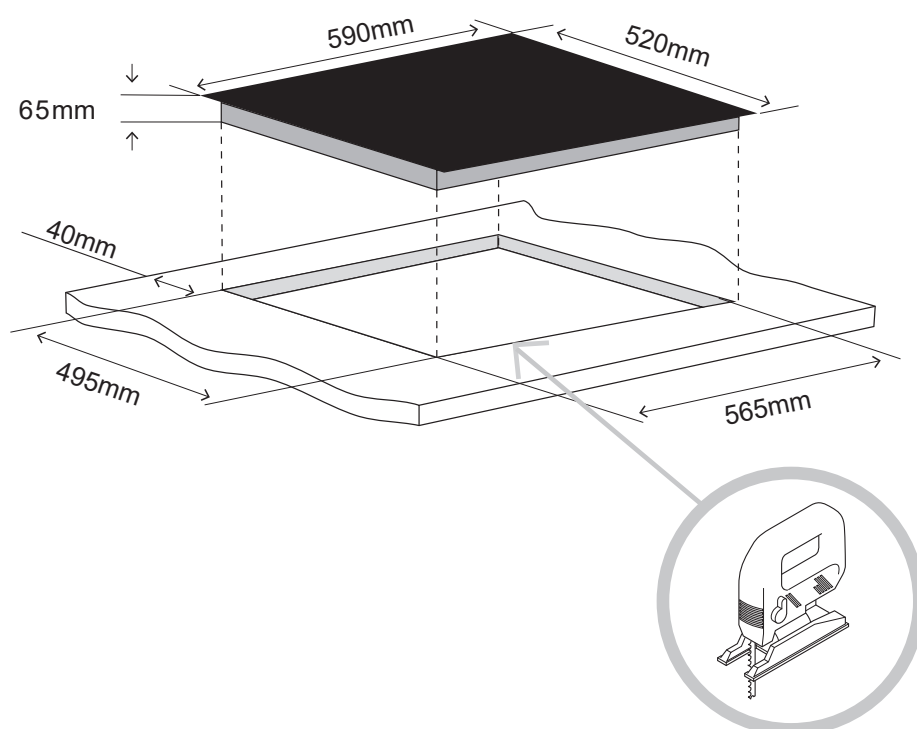

Cut an aperture in the worktop using a jigsaw as shown. The worktop should be at least 12.5mm thick and made of a heat resistant material.

Installation

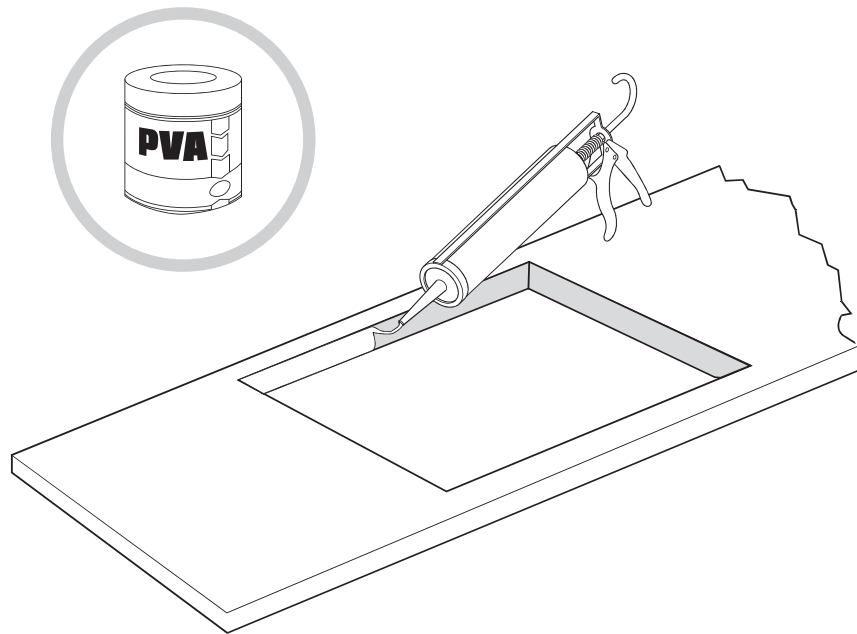

Seal the cut edge of the worktop using silicone sealant or PVA adhesive.

IMPORTANT: ensure that either product is fully cured as per the manufacturers' instructions before you commence installation of the hob. This hob **MUST NOT** be sealed into the worktop.

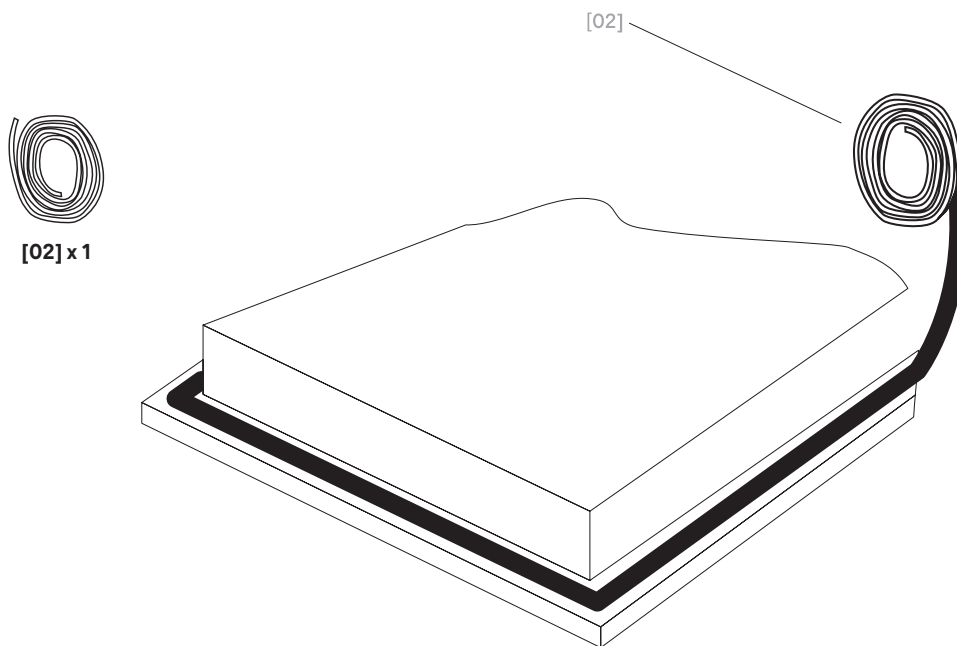

Stretch out and stick the supplied tape along the underside edge of the hob, ensuring the ends overlap. Trim off any excess tape and dispose of it.

Installation

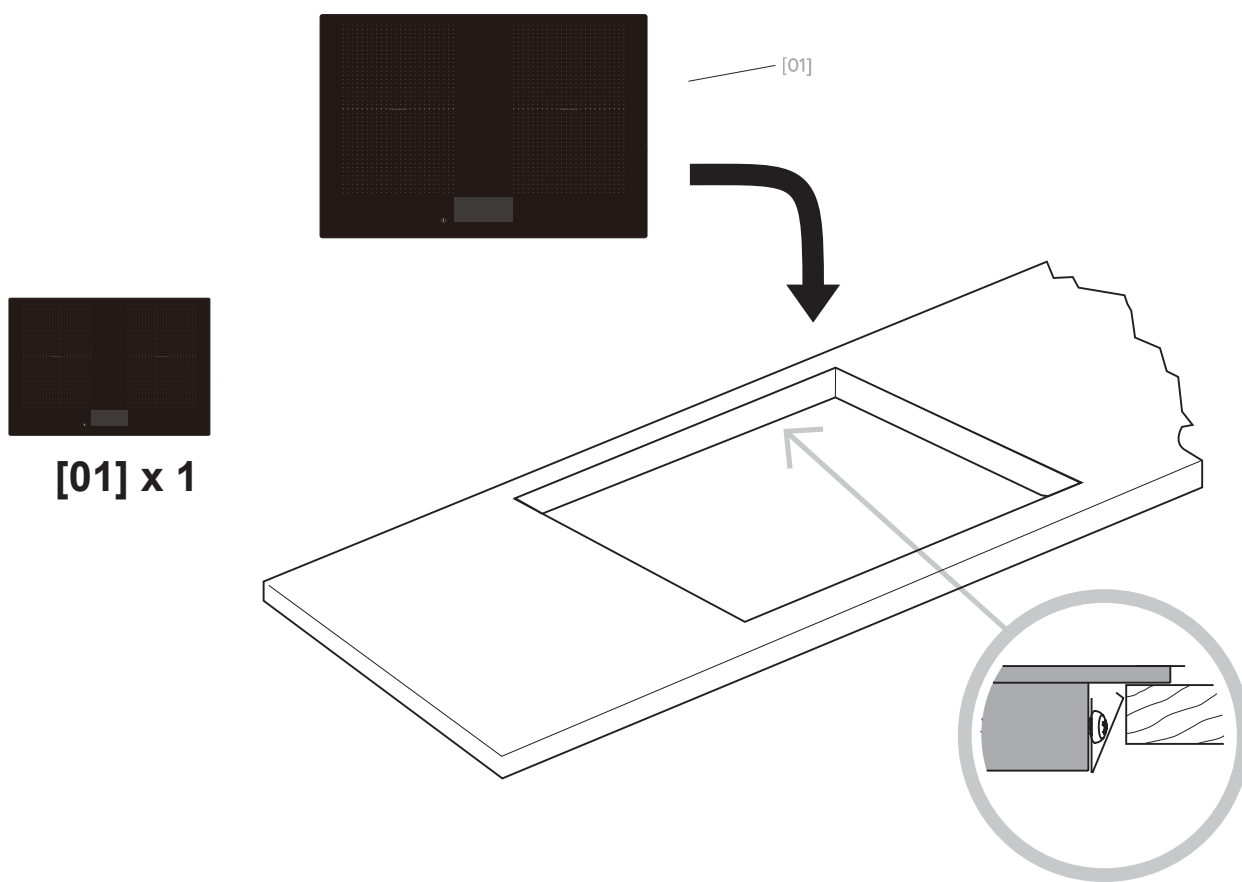

Once the worktop edge has cured, and the tape is fitted, position the hob into the cutout in the worktop. Apply gentle downwards pressure onto the hob to push it into the worktop ensuring a good seal around the outer edge.

Before you start



WARNING: Read the instructions before using the appliance

When the power is switched on at the isolation switch, the hob will beep once and the display will be blank for a few seconds before 3 dots appear indicating that the software is initiating. Once the process is complete the display will show an initial date and time, the appliance is now ready for system set up.

Induction Cooking

Induction cooking is a safe, advanced and efficient cooking technology. It works by generating electromagnetic radiation in a suitable pan that then cooks the food. There is no direct heat from the glass, though the surface will get hot due to convection heating from the pan itself; this is perfectly normal.

My new induction hob makes a lot of different noises. Does this mean that it is faulty?

- **Crackling sounds.** These noises can normally be attributed to the pans and the different materials used in their construction. The pan base will be a composition of different materials which will expand at different rates as the pan heats.
- **Clicking noises.** These are normally created by the electronic components within the appliance as they switch on and off.
- **Whistling noises.** These can be caused when one or more cooking zones are in operation at a high power level and as a result of the cookware being constructed of different materials.
- **Humming noises.** These noises can be created when a high power level is selected i.e. boost function. Noises related to high power levels will reduce as the pans heat to temperature and the power level is reduced.
- **Hissing/humming noises.** These noises can be normally heard when the hob's cooling fan is in operation.

All of the noises listed above are quite normal and do not indicate a fault. Contact Customer Services shown in the Care & maintenance section below if you need further guidance.

Cookware

Only use cookware with a base suitable for induction cooking. Look for the induction symbol on the packaging or on the bottom of the pan.

- You can check whether your cookware is suitable by carrying out a magnet test. Move a magnet towards the base of the pan. If it is attracted, the pan is suitable for induction.
- If you do not have a magnet:
 1. Put some water in the pan you want to check.
 2. Select any zone, the default power level will be set at 5 which is indicated on the display. Place your pan on the selected zone and if a question mark (?) and the words "Cookware not detected" is displayed then the pans are not suitable for this appliance.

Do not use cookware with jagged edges or a curved base.

Make sure that the base of your pan is smooth, sits flat against the glass, and is the same size as the cooking zone. Use pans whose diameter is as large as the graphic of the zone selected. You will get maximum efficiency by matching the pan size to the cooking zone and ensuring it is central. Small pans less than 12cm may not be detected.

Use

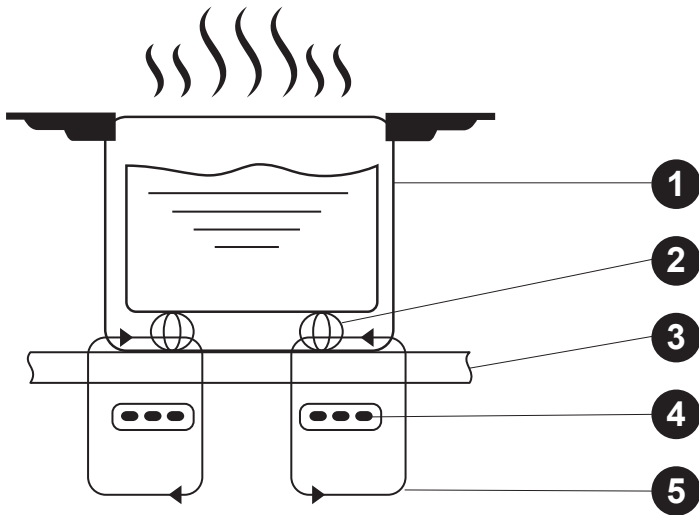

- 1. Iron pot
- 2. Magnetic circuit
- 3. Ceramic glass plate
- 4. Induction coil
- 5. Induced currents

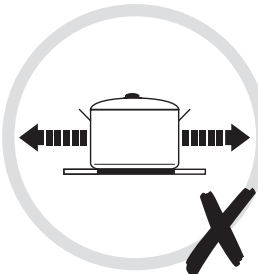
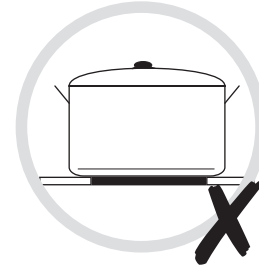
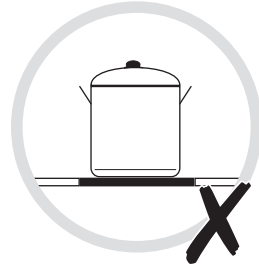
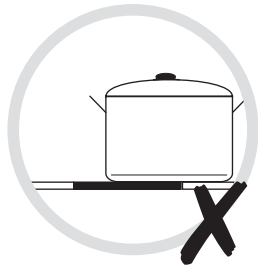
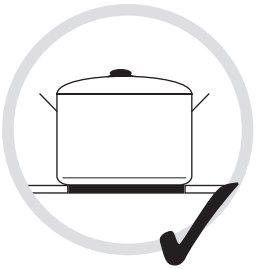
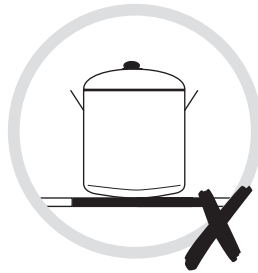
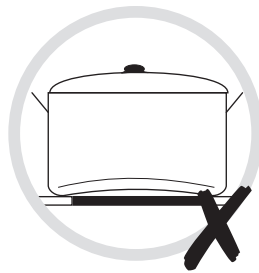
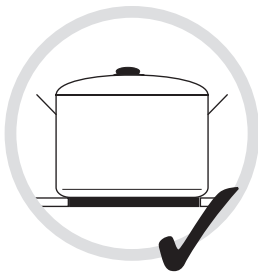
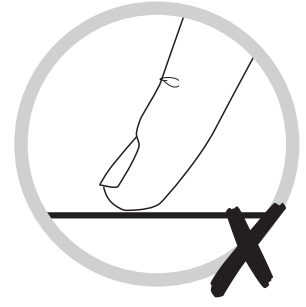
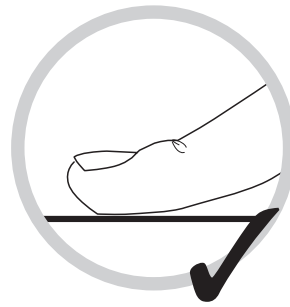

IMPORTANT: Always lift pans off the cooking surface! Do not slide or drag to avoid damaging the glass.

Use

Functions & Settings

Protection from over-heating

When the built-in sensor detects an excessive temperature, the hob will be switched off automatically.

Residual heat indicator

WARNING: The display will show the letter “H” in the relevant zone to indicate that the appliance is too hot to touch. This will be due to heat transferred to the glass from the pan by convection, and is perfectly normal for an induction hob.

Auto shutdown

If you forget to switch off a cooking zone, the appliance will automatically shutdown after a certain time. The default shutdown times are shown in the table below:

Power level	The heating zone shuts down automatically after
1-3	6 hours
4-6	3 hours
7-8	2 hours
9	90 minutes

The hob will automatically switch off after one minute once the pan has been removed from the cooking zone.

Detection of Small Articles

If the hob detects an unsuitable pan or small article (e.g. cutlery, keys) on the cooking zone, it will automatically switch off after one minute.



WARNING: People with a heart pacemaker should consult with their doctor before using this unit.

01 Description of the hob

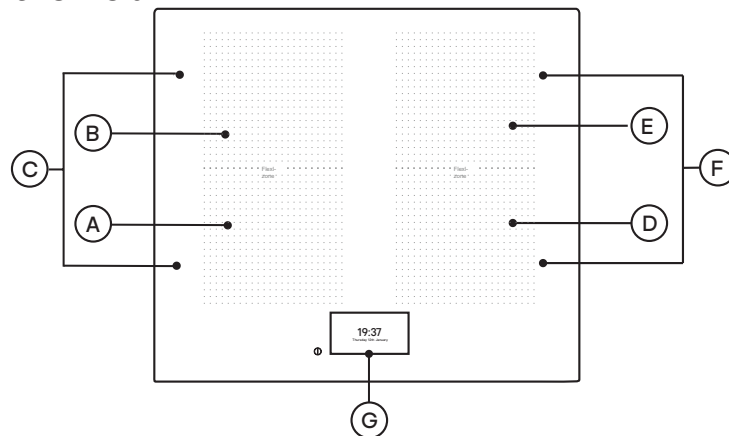

Heating Zone	Normal Power	Boost Power	Pan Diameter	
			Minimum	Maximum
Ⓐ Front Left Zone	2000 W	2800 W	Ø120mm	Ø200mm
Ⓑ Rear Left Zone	1500 W	2000 W	Ø120mm	Ø200mm
Ⓒ Left Flexible Zone	3000 W	3600 W	Width: <190mm Length: <380mm	
Ⓓ Front Right Zone	2000 W	2800 W	Ø120mm	Ø200mm
Ⓔ Rear Right Zone	1500 W	2000 W	Ø120mm	Ø200mm
Ⓕ Right Flexible Zone	3000 W	3600 W	Width: <190mm Length: <380mm	
Ⓖ Touch Control Panel				

Use

02 Description of the control panel

Your induction hob control panel © is fully touch sensitive. When the date and time is displayed on the Standby Screen, touch the panel anywhere to access the Home Screen with the induction hob controls.

Stand By Screen

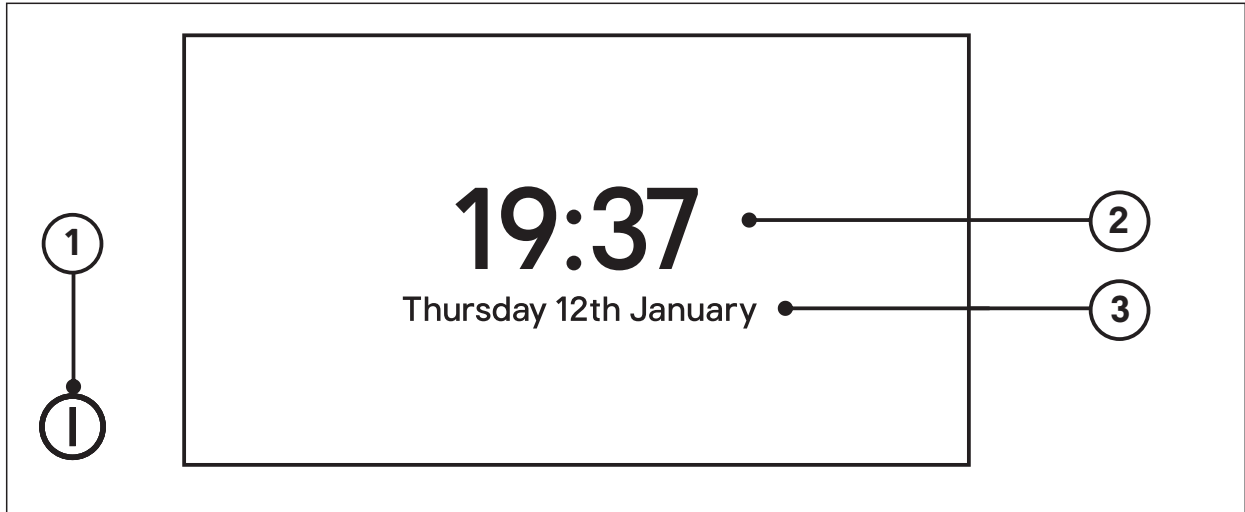

- ① Master On / Off Key ② Time Display ③ Date Display

Home Screen

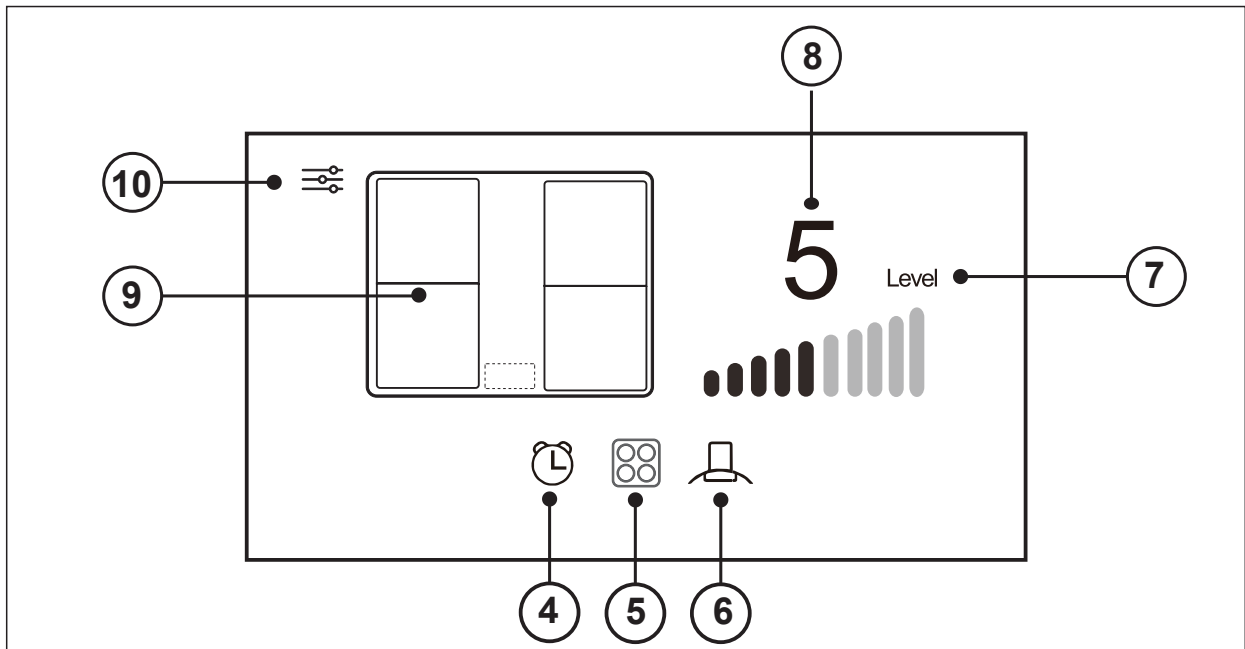

- ④ Child Lock Icon ⑦ Slider Control Key
⑤ Cooking Zones Control Panel ⑧ Master Display Key
⑥ Cooker Hood Control Panel (optional when connected to additional products, sold separately) ⑨ Cooking Zones
⑩ Main Menu

Use

Cooking Zones Control Panel

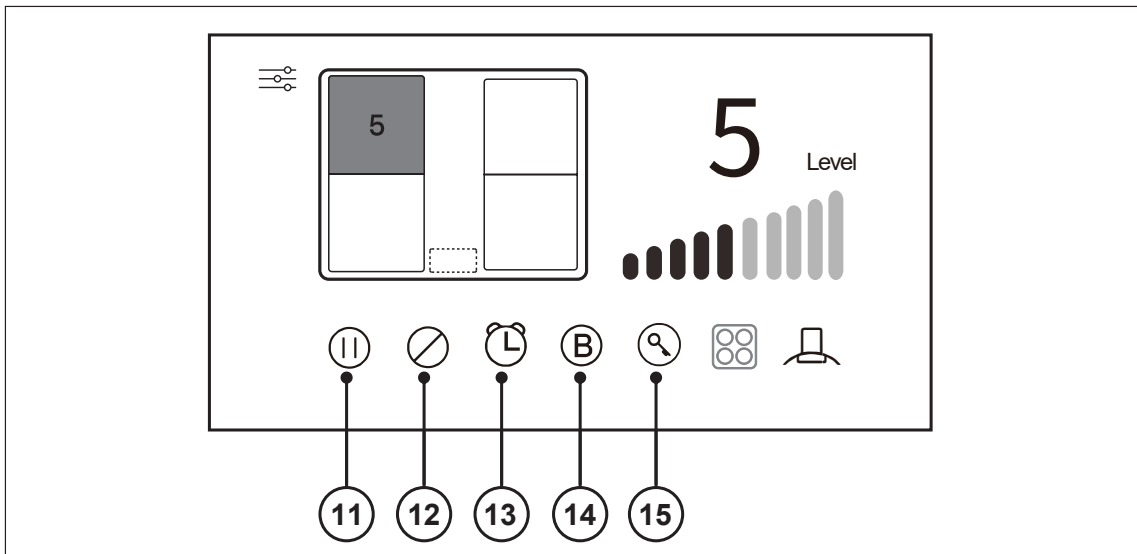

①① Pause Icon Timer

①② Stop Icon

①③ Control Icon Child

①④ Boost Icon

①⑤ Lock Icon

Cooker Hood Control Panel

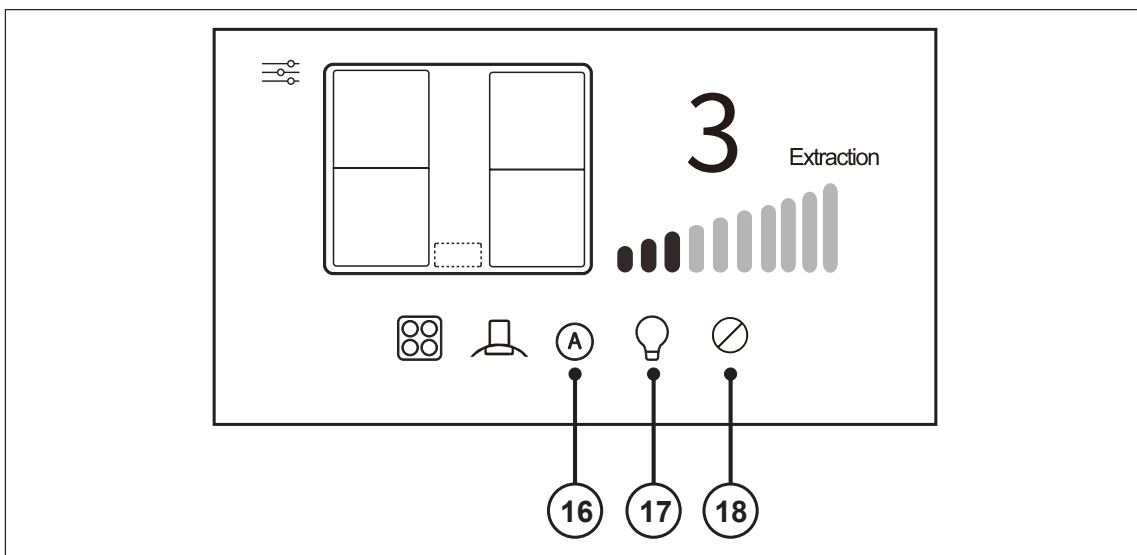

①⑥ Auto Extraction Control Icon

①⑦ Lighting Control Icon

①⑧ Stop Icon

Use

Timer Control Panel

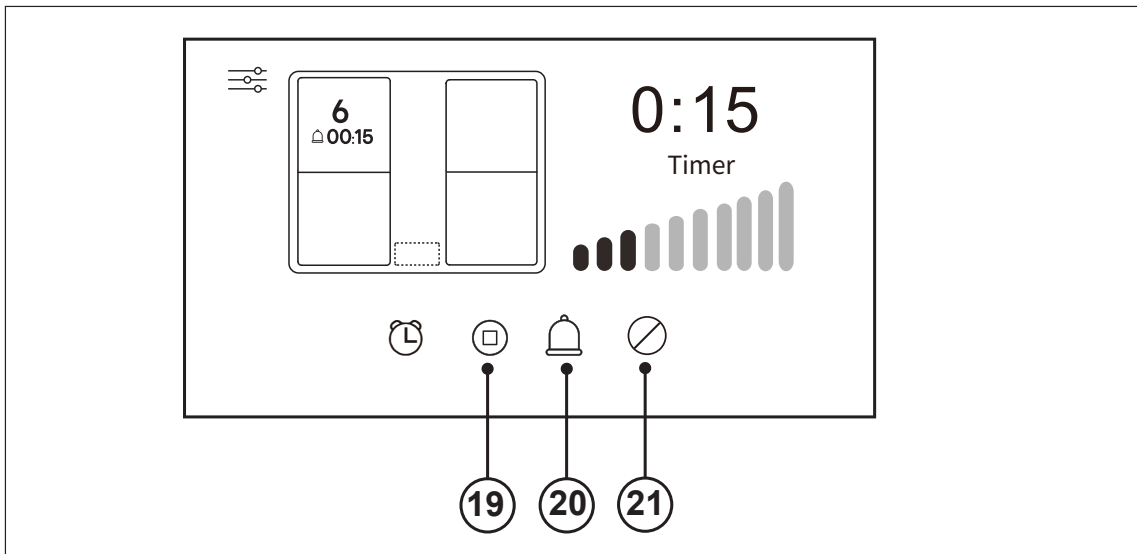

19 Automatic Switch Off Icon

20 Alarm Icon

21 Stop Icon

Settings Control Panel

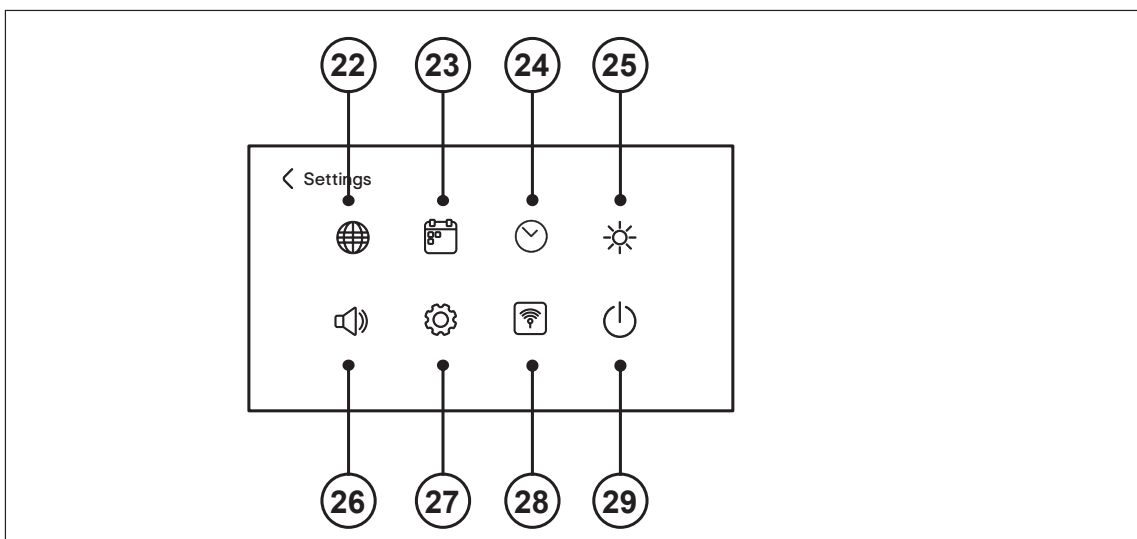

22 Language Icon

26 Volume Icon

23 Date Icon

27 Reset Icon

24 Time Icon

28 Connect Icon

25 Brightness Icon

29 Stand By Icon

Use

Using your hob for the first time

Switch on the power at the Residual Current Device and the hob will start up as shown.

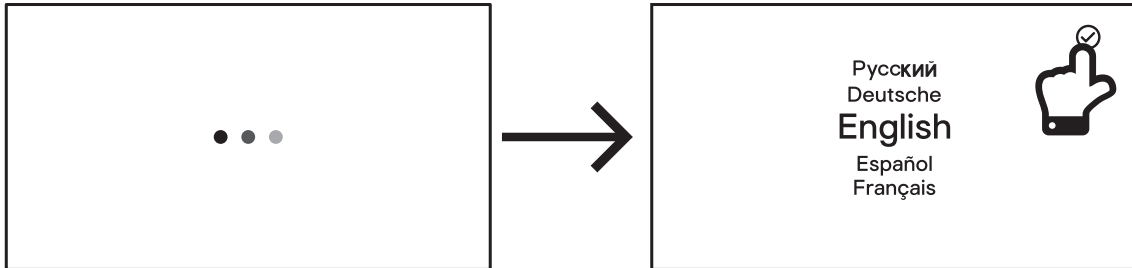

- Select your language as required and touch the Tick Icon ☑ to confirm.
- Select the date and time as required and touch the Tick Icon ☑ to confirm.

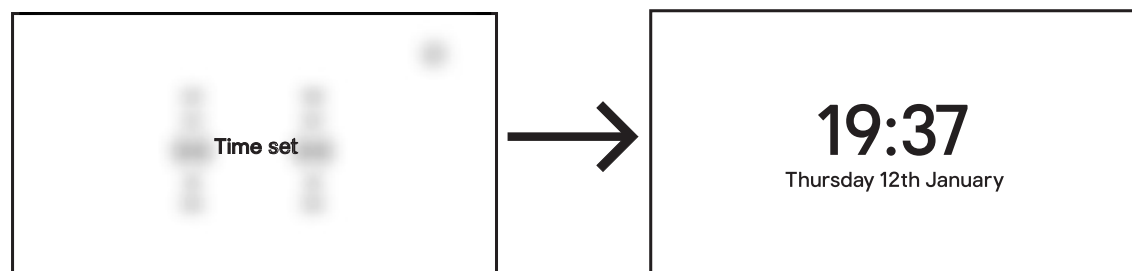
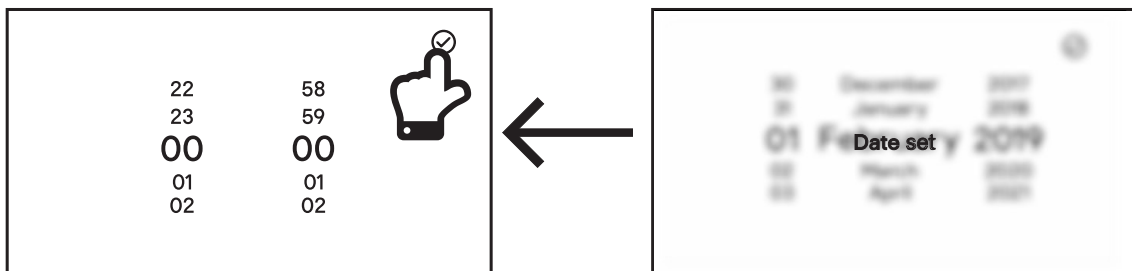
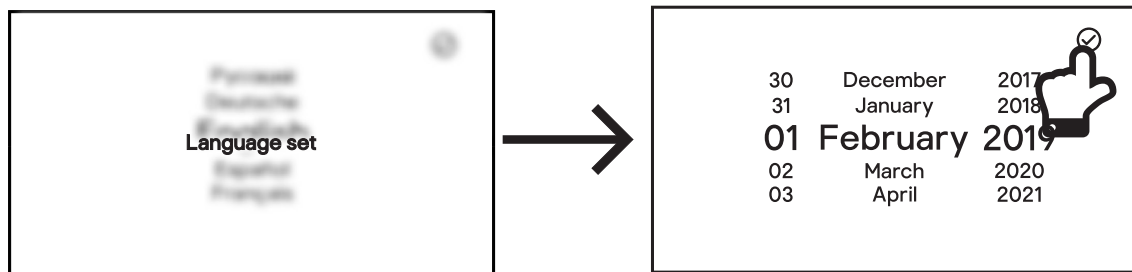

Your hob is ready for use.

In the event of a power cut, the date and time will need to be reset.

Use

System Setup

1. Touch the Master On / Off Key  for two seconds and the display shows the current date and time. Touch the screen anywhere to proceed.

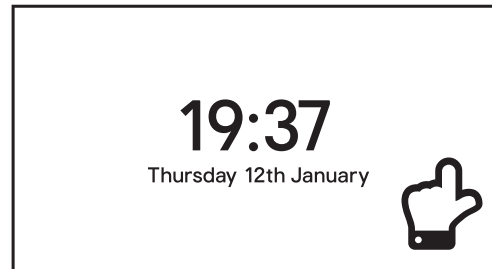

You can set different options in the system interface such as volume and brightness at anytime as follows.

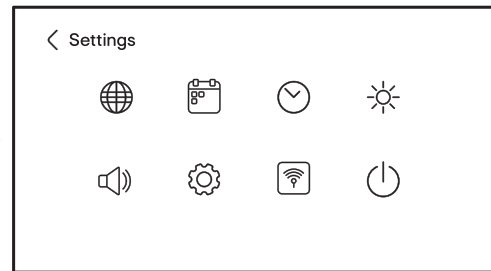
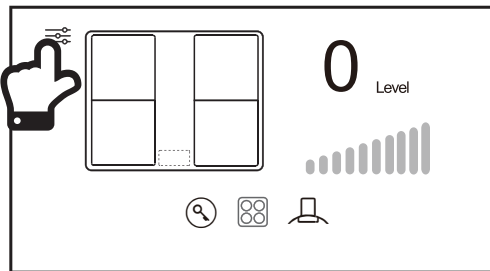

2. Touch the Main Menu Icon and then touch the Language Icon to set the desired language.

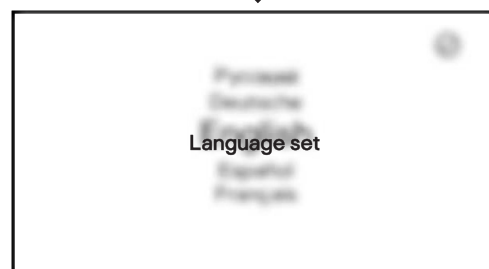
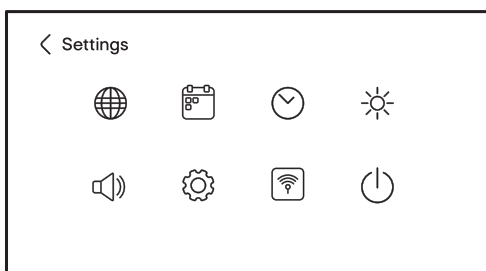
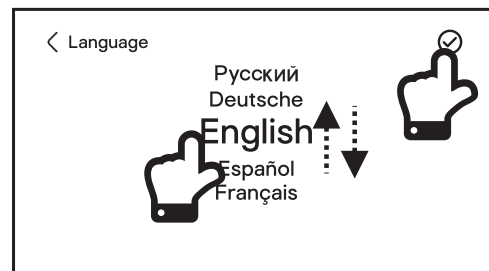
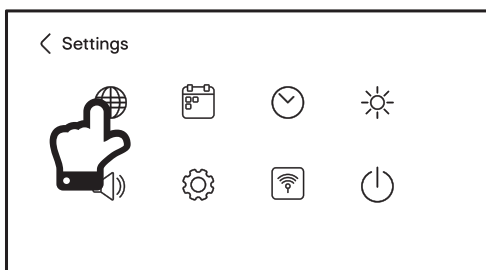

Use

3. Touch the Date icon to set the date.

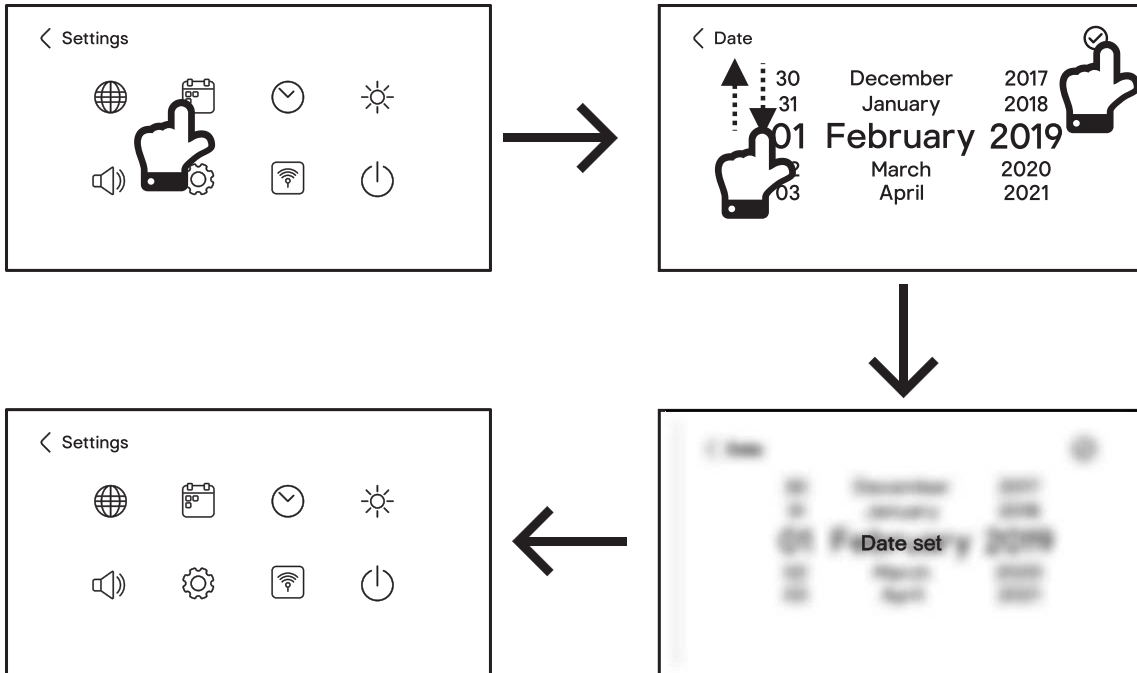

4. Touch the Time icon to set the correct time.

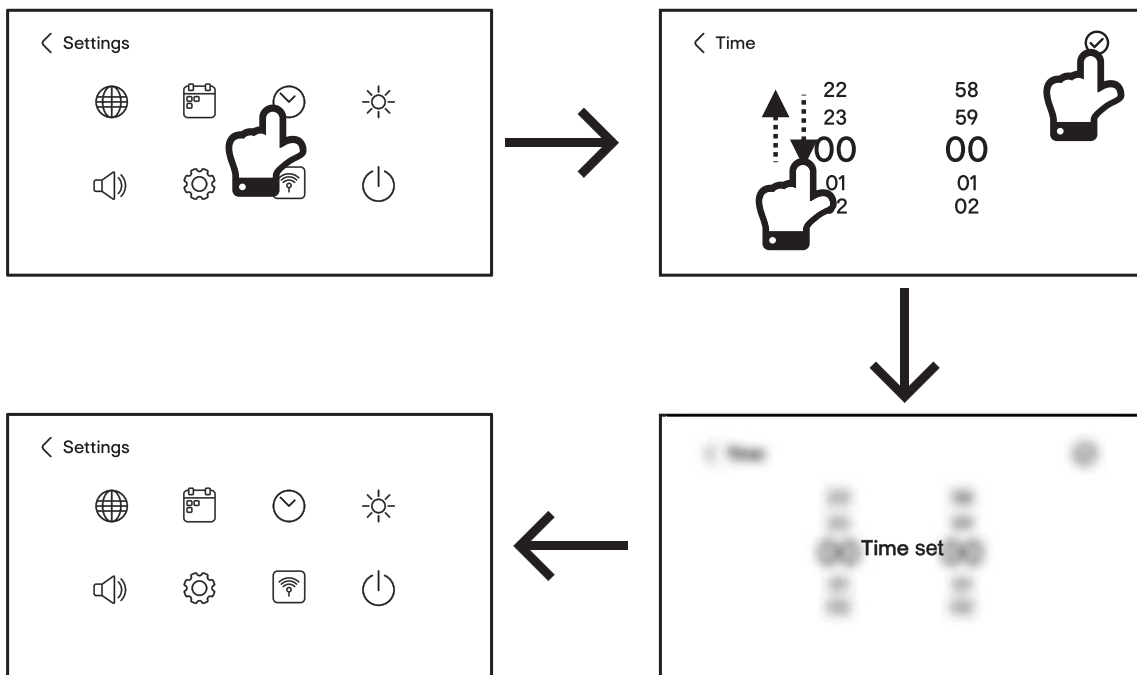

Use

5. Touch the Brightness icon to set the desired brightness level. The default brightness is set at 8 and is adjustable from 1-15.

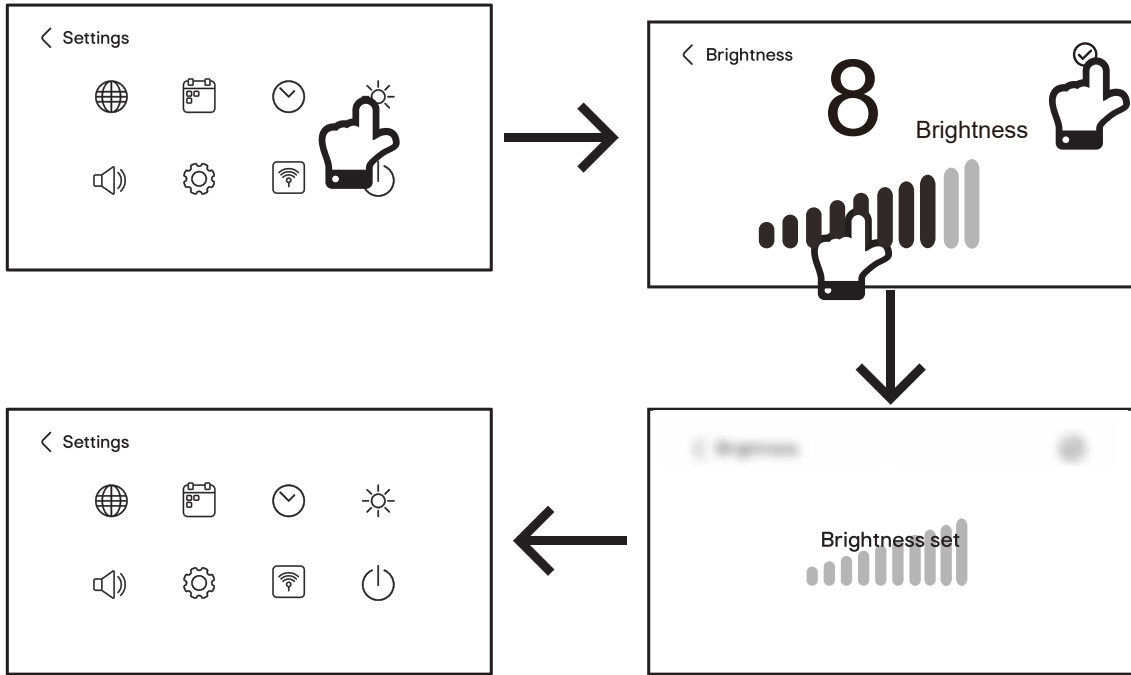

6. Touch the Volume icon to set the sound volume level. The default volume is set at 10 and is adjustable from 0-15.

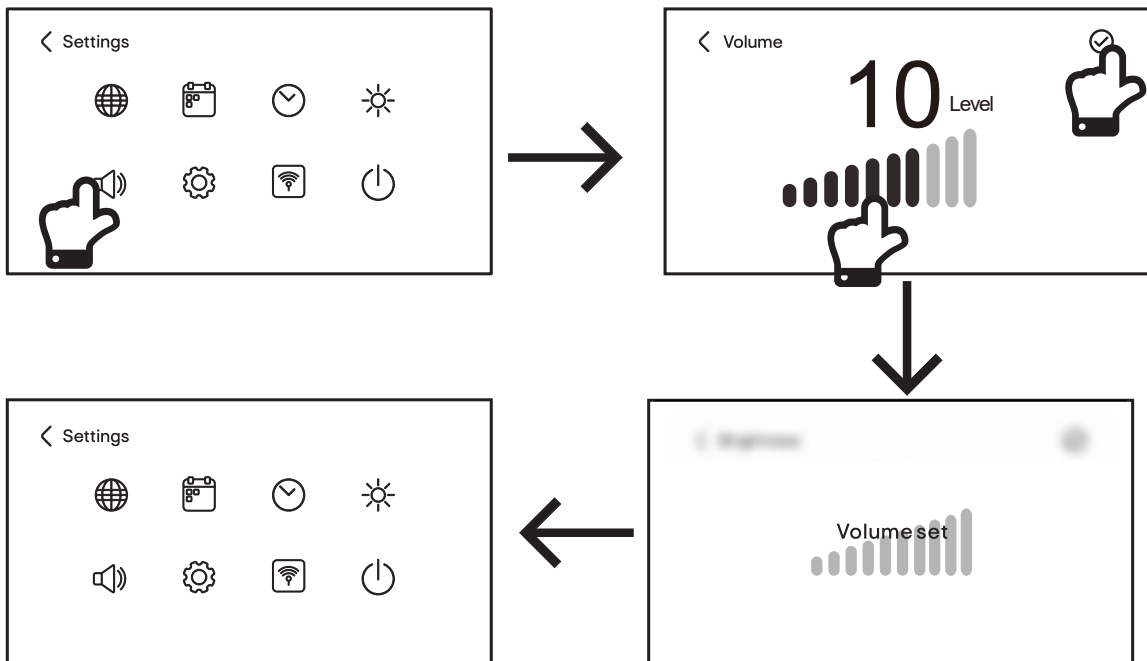

Use

7. Touch the Reset icon to restore the hob to the default settings.

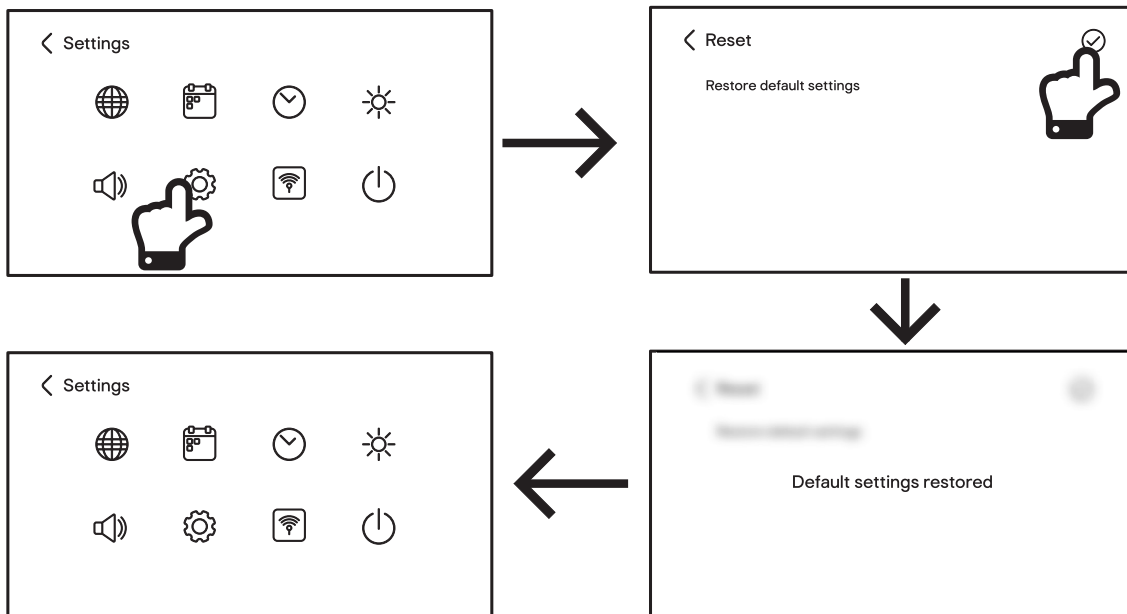

8. Touch the Connect key to initiate the pairing sequence to connect your hob to your cooker hood, if purchased separately. Please refer to the section "Controlling a cooker hood remotely" found later in this manual.

9. Touch the Stand By icon to set the amount of time before the Control Panel reverts to the Stand By Screen.

(a) By default the Stand By Screen time is set to 5 minutes and can be adjusted from 0.5 to 59 minutes.

(b) The Stand By Screen will automatically switch off after 2 minutes and is not adjustable.

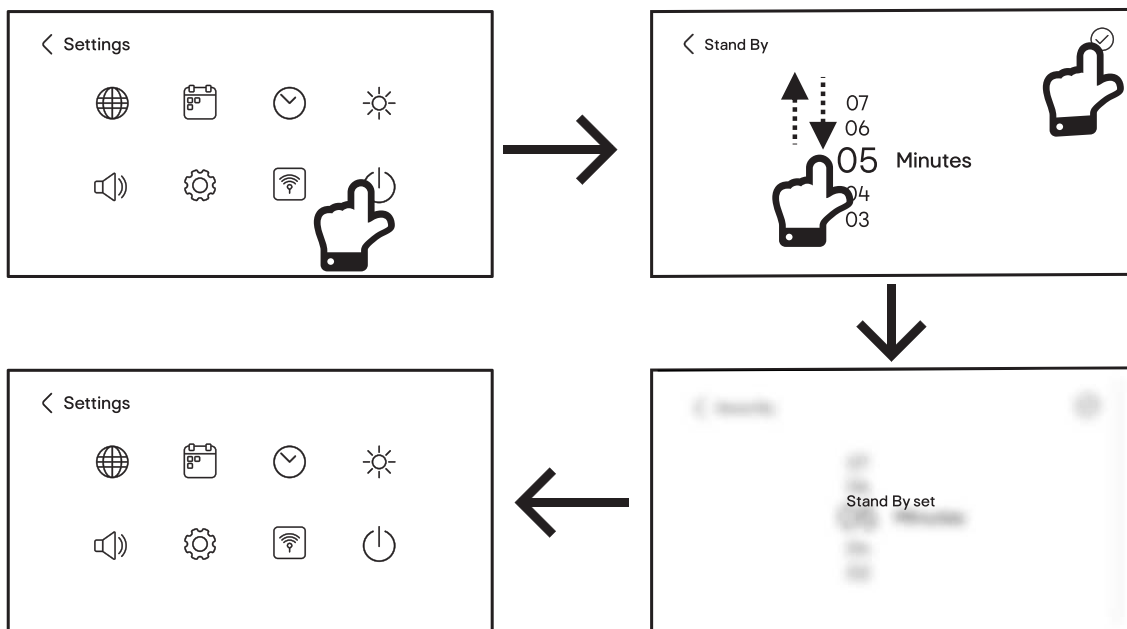

Use

01 Using your induction hob

1. Touch the Master On/Off Key  for two seconds and the display shows the current date and time. Touch the screen anywhere to proceed.

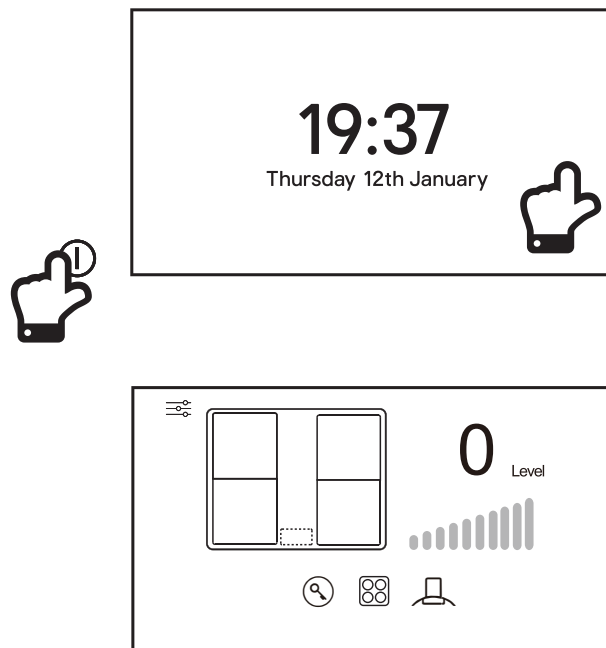

2. Place a clean and dry pan, suitable for induction cooking, on the chosen heating zone.
3. Touch the heating zone on the panel and it will change to orange and show the default power Level 5. The Slider Control Key will also show Level 5.

Note: Always ensure that the zone you wish to control is highlighted orange first.

4. Adjust the Slider Control Key to the required power level between 1-9 by sliding your finger around the coloured perimeter. You can also touch the perimeter anywhere to jump straight to a new power level. For example, touching the perimeter at 7 o'clock will go to level 6. The selected cooking zone will show the new power level during adjustment and this can be changed at any time during use.

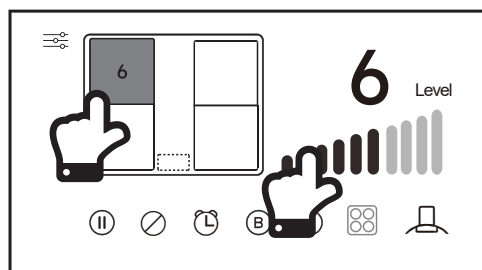

Use

5. To stop cooking, touch the appropriate zone (or zones) on the control panel, followed by the Stop icon .

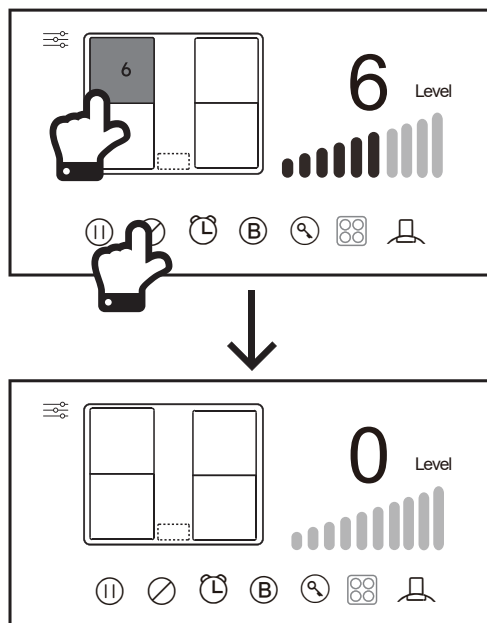

CAUTION: After use, each cooking zone will display "H" as a reminder that the glass is too hot to touch. Though induction cooking does not generate heat, the magnetism used to heat the pans will mean that this heat will still transfer to the glass surface by convection. This is perfectly normal for induction hobs.

The control panel will show "?" and "Cookware not detected" if:

- the pan is on the wrong cooking zone
- the pan is not compatible with induction hobs
- the pan is too small or not correctly centred on the zone

As a result the zone will automatically switch off after one minute.

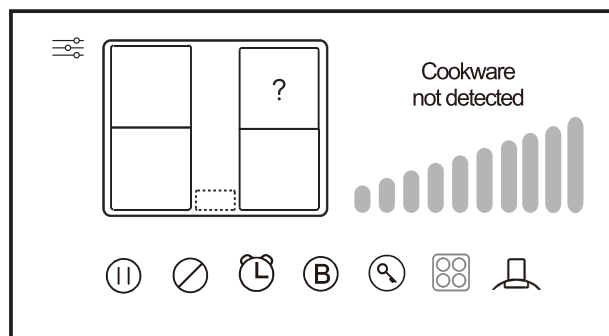

NOTE: The control panel will not automatically switch off when "H" is displayed. When "H" disappears, the set Stand By time will commence.

Use

02 Using the flexible zone

The left zones [Ⓐ] and [Ⓑ] can be used individually at the front or the rear, or configured to work as a flexible zone [Ⓒ].

When configured as a flexible zone, the front and rear areas are linked and can be controlled with one power setting.

As before, ensure that the pans are placed correctly on the selected cooking zone. Here are examples of good and poor placement across a flexible zone.

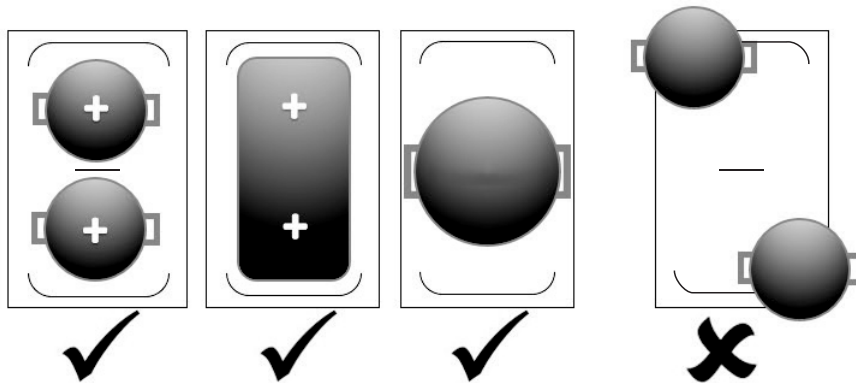

Linking two zones together:

To link the two left zones together slide your finger across both zones in one smooth movement. As you do this, a bold white line will be drawn across the panel, and when released, the left zones will be connected as one with the default power level 5 shown. Ensure you release your finger within the flexible zone to connect.

Adjust the Slider Control Key to the required power level as required.

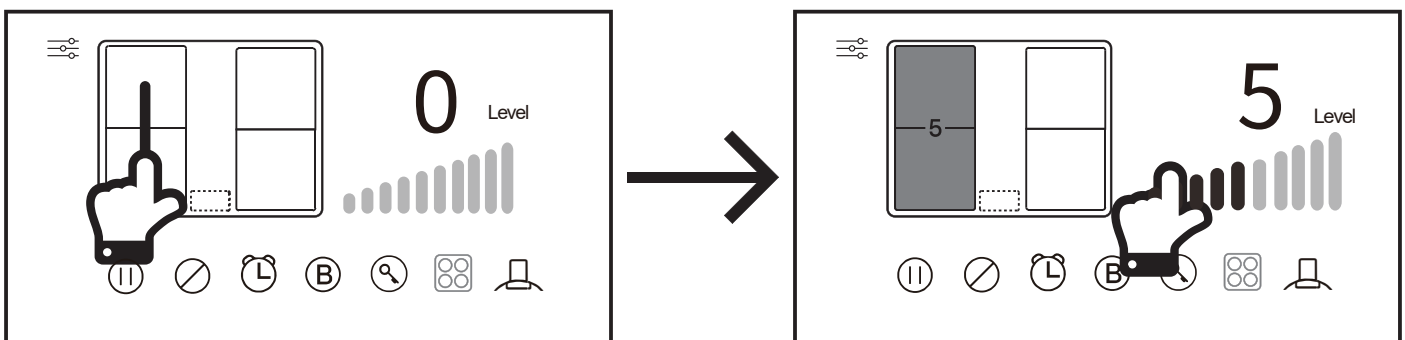

Use

03 Extending the flexible zones

1. It is also possible to select three zones in the following way.

! **IMPORTANT:** Any zones that are linked will be highlighted in orange and all controlled together using the Slider Control Key.

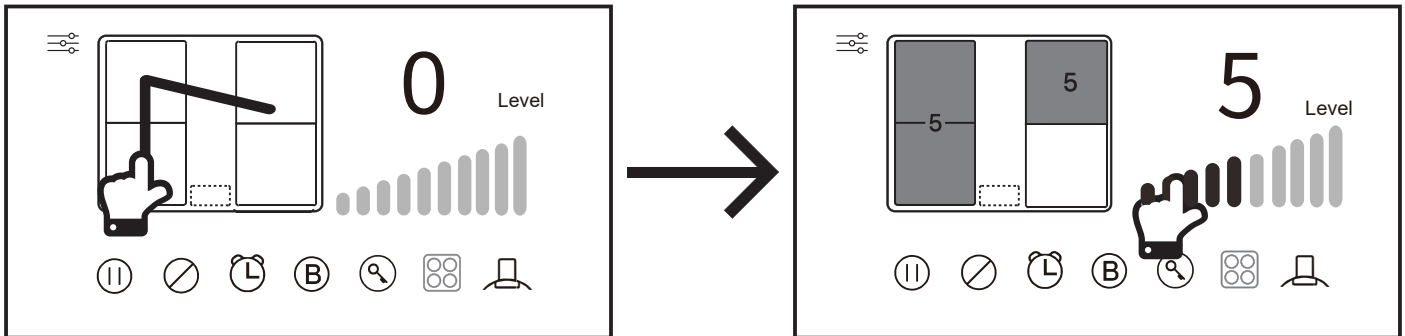

2. You can also select two or more non-adjacent zones by sliding your finger across the panel as required.

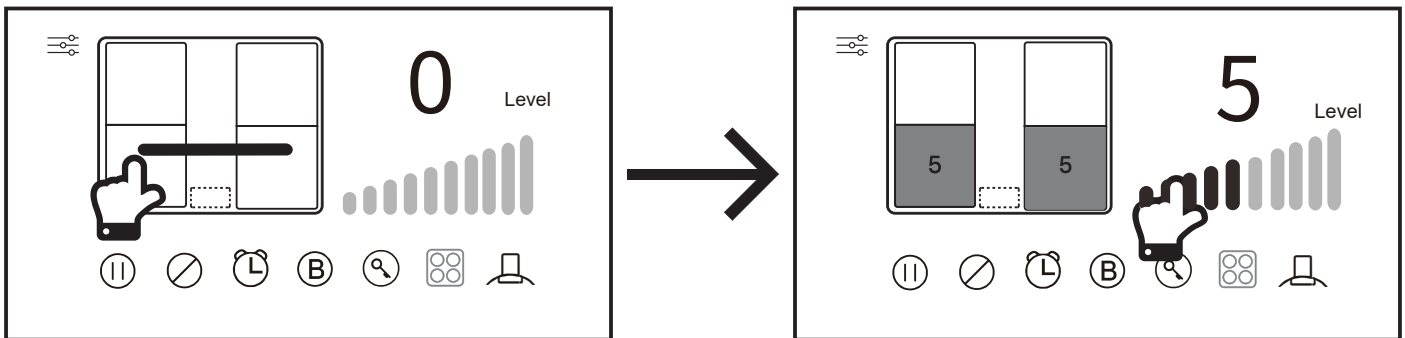

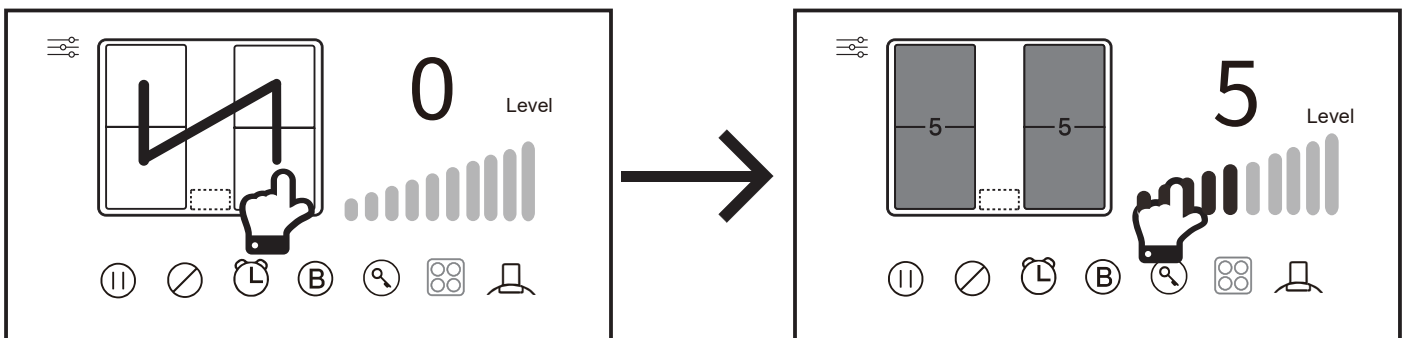

3. Or to select all four cooking zones, again slide across the panel in one movement.









Use

04 Using the boost function

Switching the Boost function on.

1. Select the required cooking zone you would like to apply the Boost function to.
2. Touch the Boost Icon  and the selected cooking zone and the Slider Control Key will display  and start a countdown timer of 5 minutes. The Boost Icon  will turn orange.

 **IMPORTANT:** To avoid overheating, the Boost function can only operate at maximum power for 5 minutes and after this time, the power level will automatically drop to 9.

As before, multiple cooking zones can also be selected and used with Boost for a maximum of 5 minutes. However, all zones cannot operate on Boost together. You can use Boost on zones  or  or  as a flexible zone. Additionally Boost can be used on  or  or  as a flexible zone.

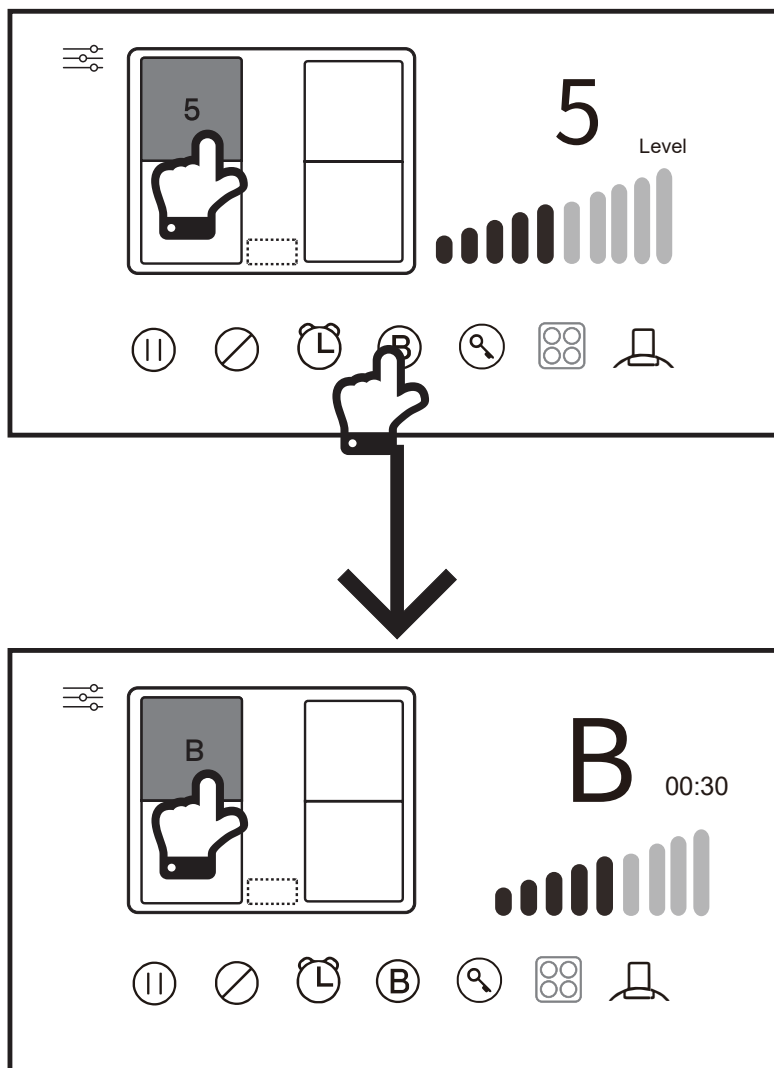

Cancelling the Boost function

1. Ensure the cooking zone using the Boost function is highlighted orange.
2. Touch the Slider Control Key to select the new power level, or press Stop Icon  to switch off the zone completely.

Use

05 Using the timer

Using the timer as an audible alarm

1. Select the cooking zone (or zones) that you wish to control.
2. Touch the Timer Control Icon  and the Slider Control Key changes to a timer.

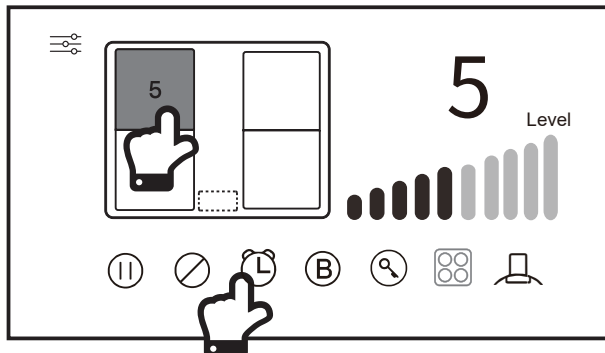

3. Minutes are automatically selected first; rotate the Slider Control Key from 01-59 minutes as required.

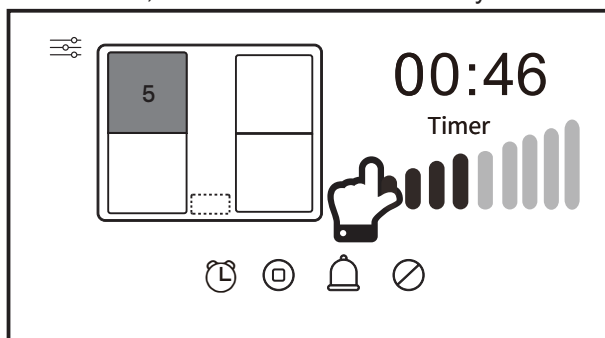

4. Touch the 0 hours and rotate the Slider Control Key from 0-6 as required. Refer to the table below to determine the maximum time permitted by power level.

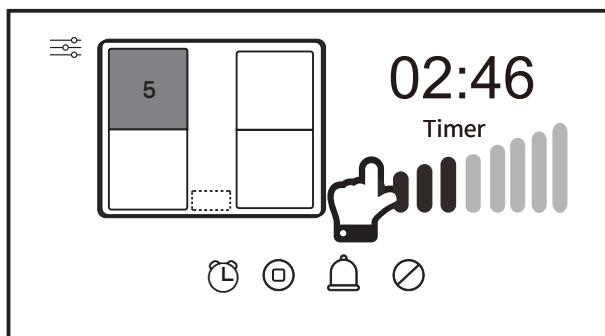

NOTE:

Power level	Maximum Time permitted
1-3	6 hours
4-6	3 hours
7-8	2 hours
9	90 minutes

5. Touch the Alarm Icon  to set the timer as an alert only and the cooking zone will continue to function at the selected power level and show the timer within the zone. The timer will countdown and when complete, will sound an audible alarm and display the "Timer complete" message.



IMPORTANT: The cooking zone will continue to operate at the selected power level and will not switch off!

Use

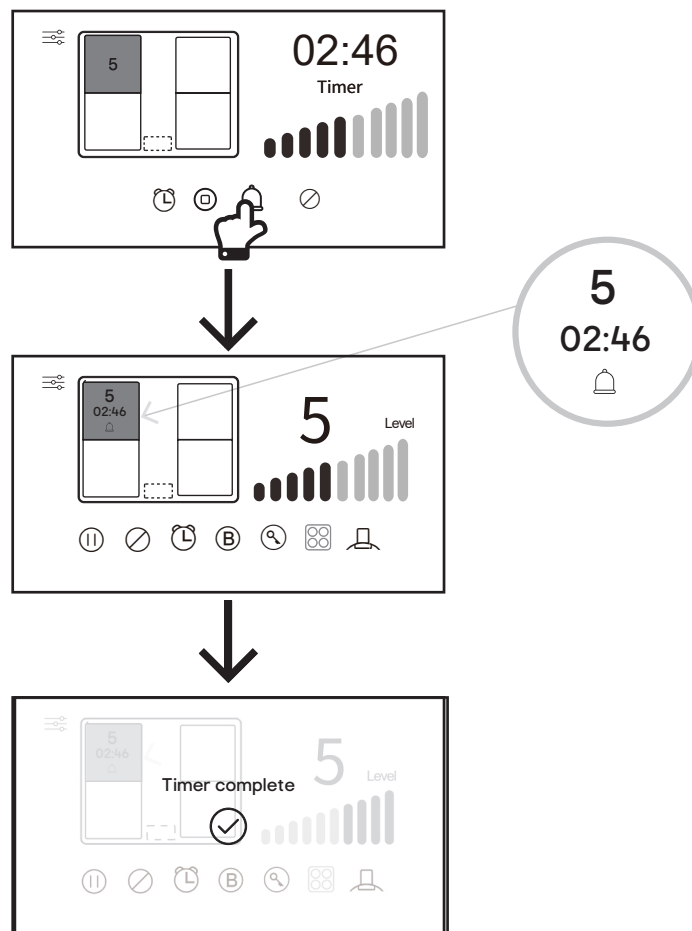

Using the timer to automatically switch off your cooking zone

1. Follow the steps 1-4 above in the "Using the timer as an audible alarm section."
2. Touch the Automatic Switch Off Icon  to set the timer to automatically switch the selected cooking zone off. The timer will countdown and when complete, will sound an audible alarm and display the "Timer complete" message. The cooking zone will be switched off.

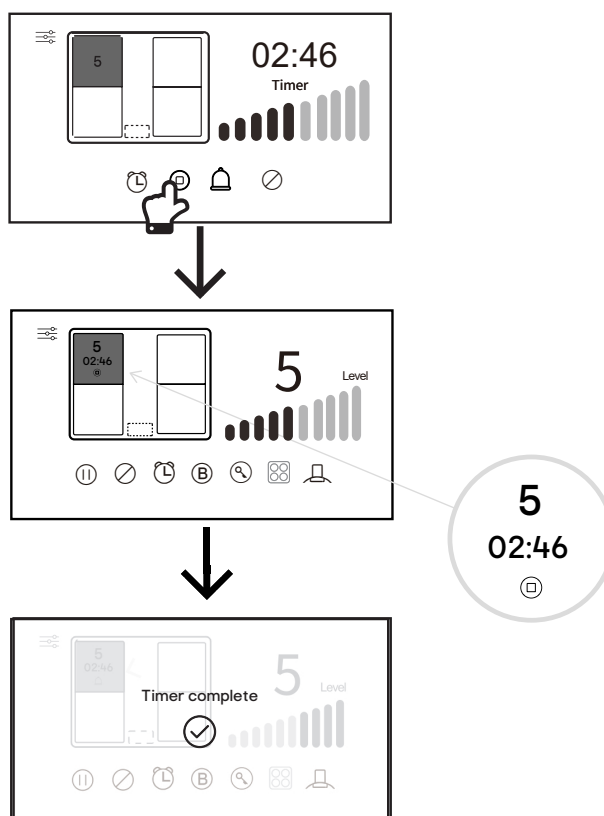

Use

06 Using the Child Lock

The Control Panel can be locked to prevent accidental use, and when selected all controls are disabled except for the Master On/Off Key ①

The hob can also be locked during cooking but if the Master On/Off Key ① is pressed, cooking will be stopped. Note that when the hob is turned back on, the Child Lock will still be operative.

Switching the Child Lock on

If you are cooking, touch the Child Lock icon and ② will be displayed on screen. All functions are now locked until you disable this feature.

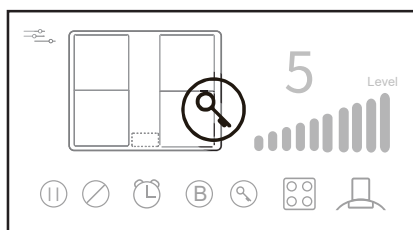

You can also activate the Child Lock from the Home Screen before cooking to ensure that the panel is locked after touching the Stand By Screen.

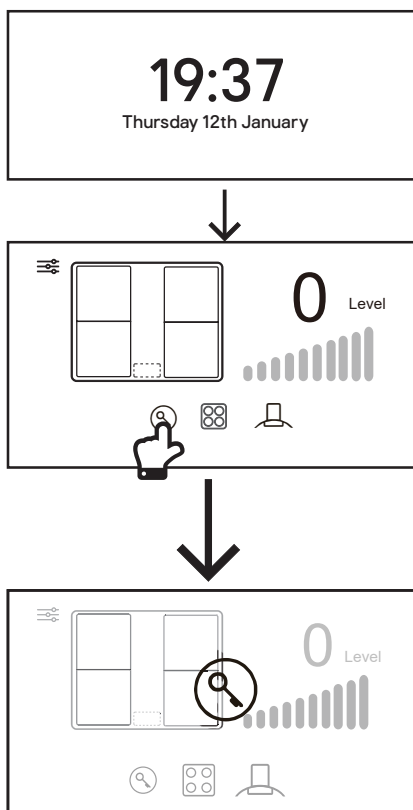

Cancelling the Child Lock

Touch and hold the large Key icon and it will initiate a visible countdown timer lasting 3 seconds after which time all hob functions will be accessible again.

If the Child Lock function is activated during cooking, the hob will continue to work as programmed. Cancel the Child Lock as described above to access all functions again.

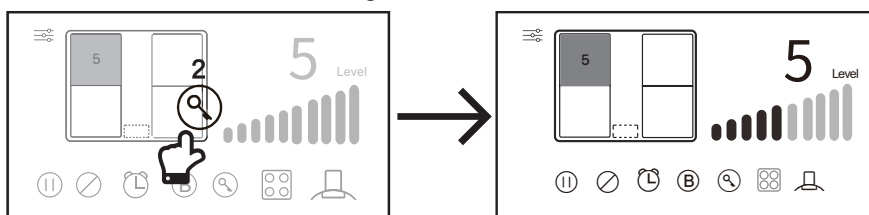

Use

07 Using the Pause Cooking function

The cooking process can be temporarily paused in case of interruption.

Switching the Pause Cooking function on

Touch the Pause icon  and the large pause icon will be displayed on screen. All cooking zones will turn off and any timers that have been set will also pause.

Cancelling the Pause Cooking function

Touch the large Pause icon displayed on the Control Panel and all selected cooking zones and timers will recommence from the previous paused settings.

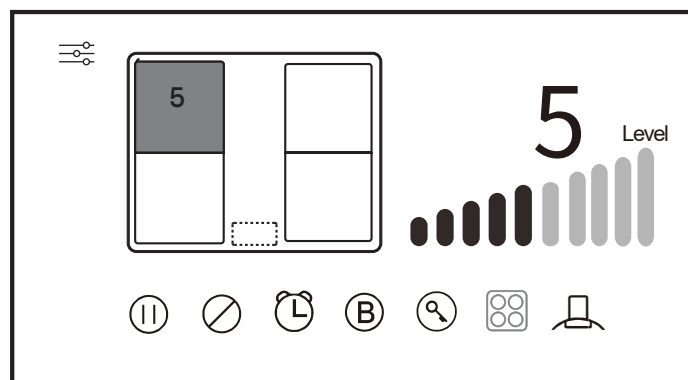
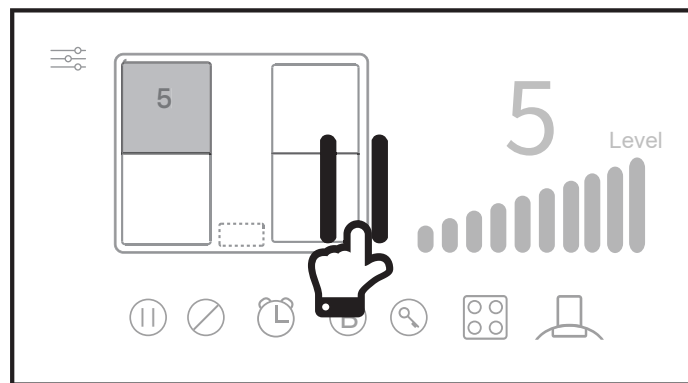
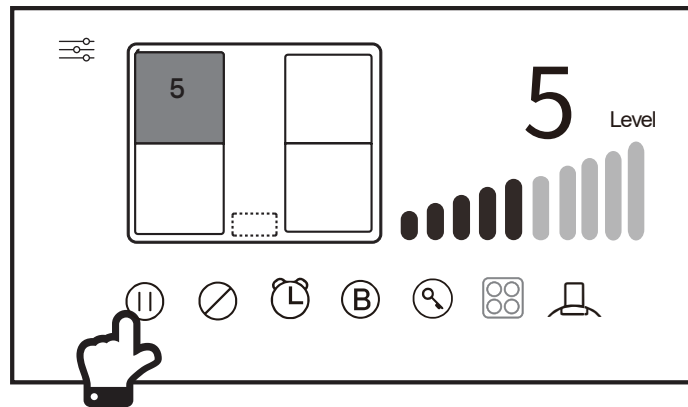

Use

Controlling a cooker hood remotely

! **IMPORTANT:** This section is only applicable if you have purchased a cooker hood.



The process for connecting the hood to the hob happens in three stages:

- A) Configure the hob to transmit a radio frequency signal.
- B) Configure the hood to receive this signal.
- C) Lock the connectivity between the two appliances and complete the pairing process.

STAGE A

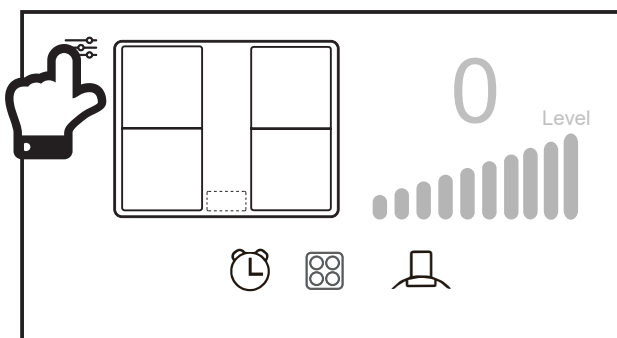
1. The induction hob must be switched on and showing the Home Screen display before proceeding.



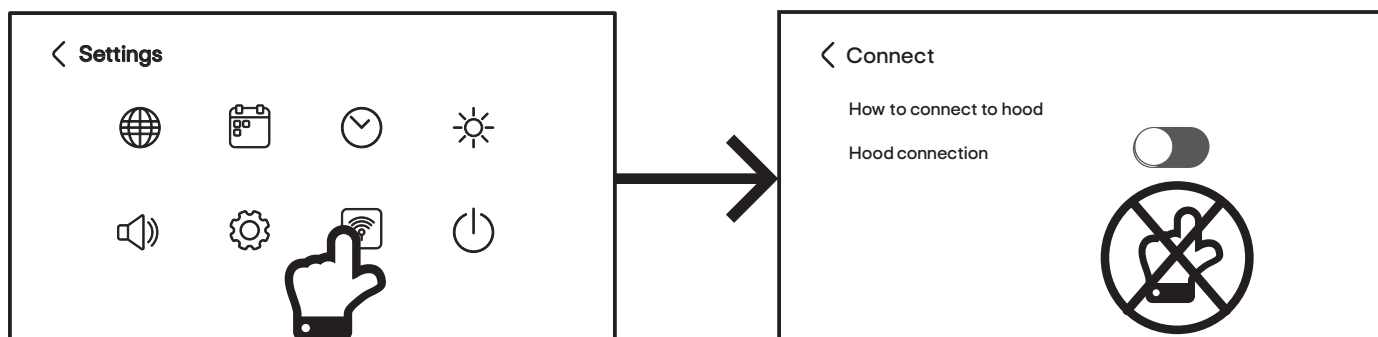

2. Touch the Main Menu key  on the Home Screen to take you to the Settings menu. Touch the Connect icon  to initiate the pairing sequence and transmit a radio frequency signal from the hob. Do not touch the Hood connection button on the hob yet!



! **IMPORTANT:** To proceed with the connectivity operation, the hood must be switched off at the mains power switch. Turn on the hood again and complete Stage B and C within two minutes. If connection is not successful, turn off the hood again, wait for one minute and try again.

STAGE B

1. When the hood is first switched on, the control panel will blink white in Settings mode.
2. Touch the Fan Speed Increase icon  and Fan Decrease icon  together for two seconds on the hood control panel and both icons will turn orange and the Automatic symbol "A" will appear in the display. The hood is configured to receive the signal.

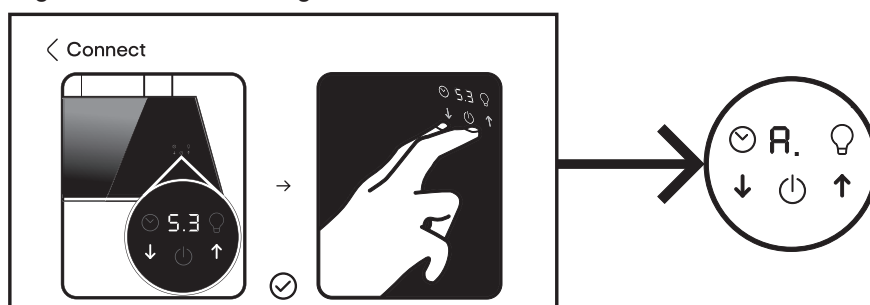

Use

STAGE C

1. Now touch the Hood connection button  on the hob and it will turn orange.
2. The hob will briefly show a connected message to indicate that the hob is now locked with the hood and the pairing process is complete. The hood will also show the double "A" symbols in its control panel to indicate pairing is complete.

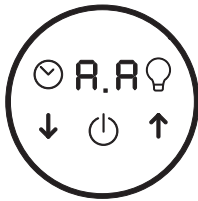
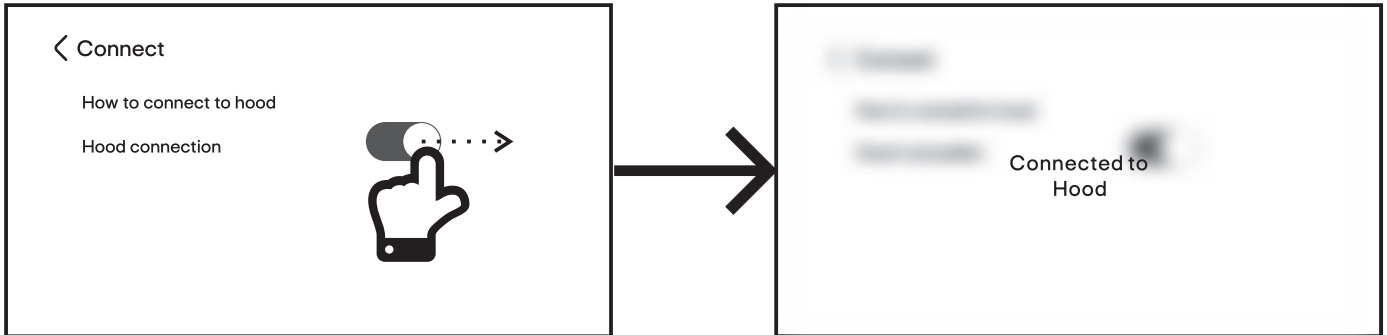

IMPORTANT: Once the hob and hood are paired and locked together you can now choose to use your appliances in three ways, Independent Control, Semi-Automatic Control and Automatic Control.

1. Independent Control - The Hood connection button on the hob is OFF and you can operate the hood's fan and extraction manually as required independently of any settings on the hob.
2. Semi-Automatic Control - The Hood connection button on the hob is ON and you can control the hood's fan and extraction manually from the Slider Control Key on the hob control panel.
3. Automatic Control - The Hood connection button on the hob is ON and the hob will control the hood's fan and extraction based upon the power levels in use on the hob.

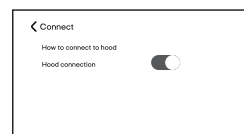
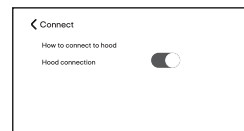
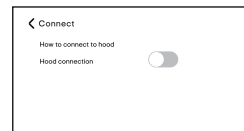

NOTE: You do not need to complete the pairing process again if you switch off the Hood connection on the hob. The link is stored in memory and will be reactivated once you have switched Hood connection back on.

NOTE: If you touch the Cooker Hood Control Panel key before connectivity is complete you will see this message on screen:

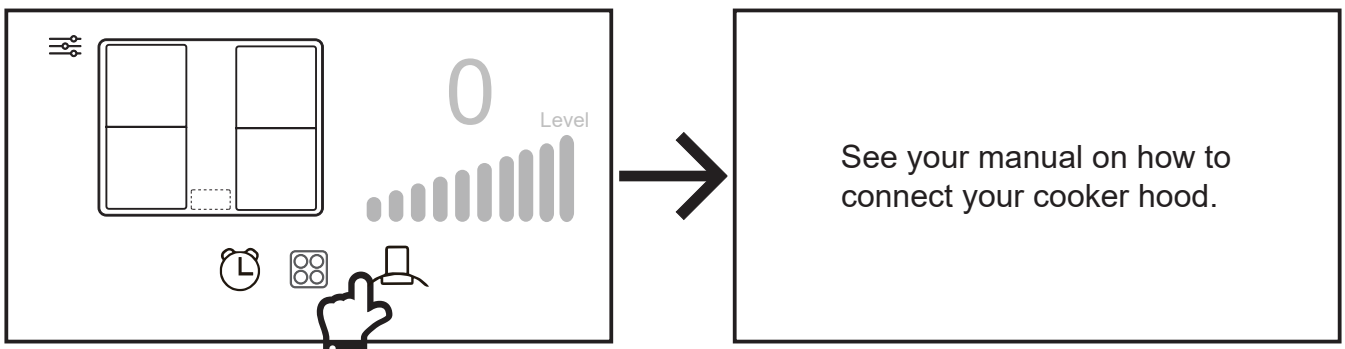

Use

01 Controlling the cooker hood from your hob

Ensure the hob and hood connectivity has been completed and the Hood connection button is ON!

1. From the hob Home Screen, touch the Cooker Hood Icon  to access the Cooker Hood Control Panel, and the icon will turn orange.

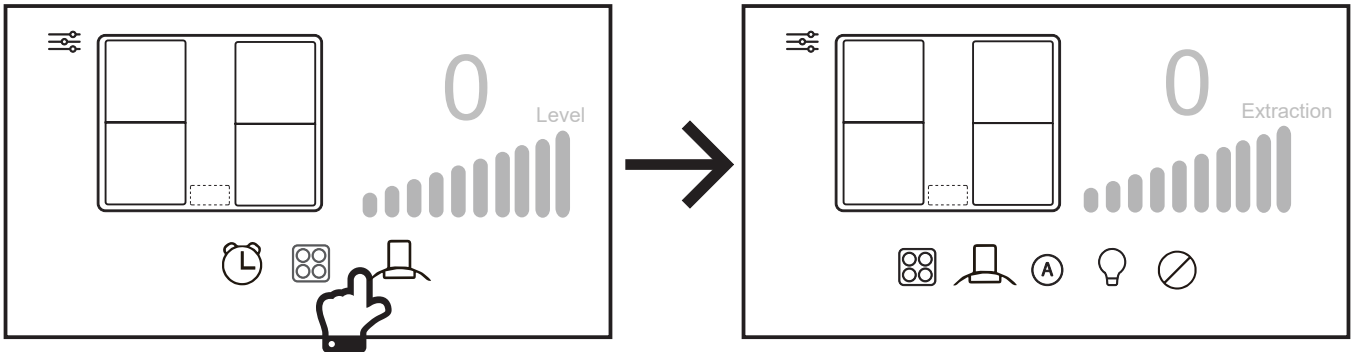

2. To control the extraction rate of the hood manually, rotate or touch the Slider Control Key from 0-5 and B for boost. The Hood On/Off Icon on the hood will alternately flash orange and white. This is Semi-Automatic Control.

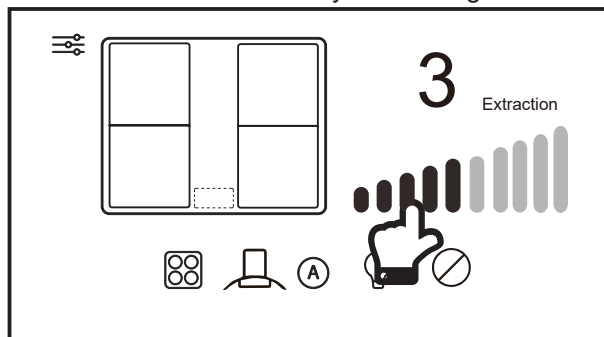

3. To control the extraction rate of the hood automatically, touch the Auto Extraction Control icon on the hob. The  icon will turn green in colour and the hob will now automatically adjust the extraction rate of the hood according to the power output of the hob. See the table below for details. This is Automatic Control.

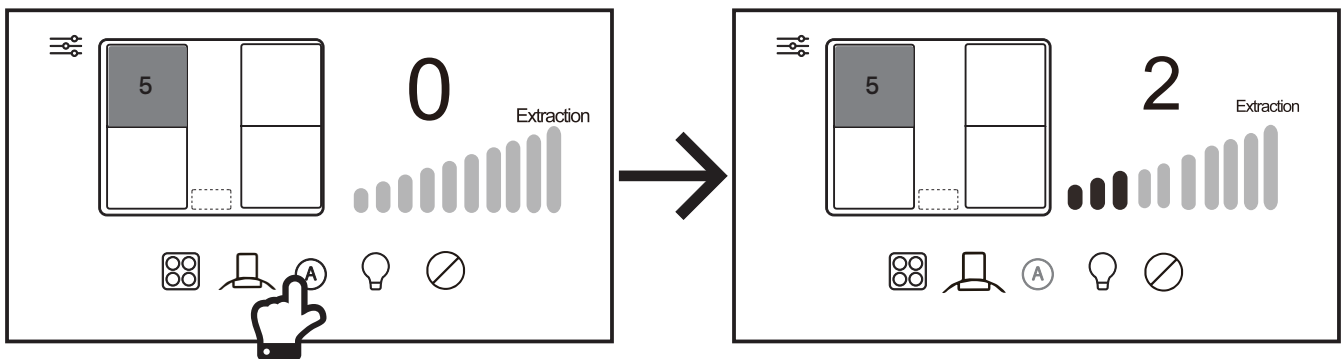

IMPORTANT: The extraction rate of the hood will vary based upon the total power output selected on the hob, as shown in the table below.
Each hob cooking zone has a maximum rated output of 10 comprising 1-9 and Boost (10).

Speed Level of the Hood	Combined Power Output of the Hob
Speed 2	This speed will be selected when the combined power output of all zones is 8 or less. For example Zone A is on 3 and Zone B is on 4.
Speed 4	This speed will be selected when the combined power output of all zones is between 9 and 24. For example Zone A is on 3, Zone B is on 4 and Zone D is on 6.
Speed 5	This speed will be selected when the combined power output of all zones is between 25 and 32. For example Zone A is on 9, Zone B is on 8, Zone D is on 7 and Zone E is on 6.
Speed P - Boost	This speed will be selected when the combined power output of all zones is greater than 32. For example Zone A is on 8, Zone B is on 9, Zone D is on 9 and Zone E is on 10.

Note: Speed 1 and Speed 3 on the hood are not available when using this function.

Use



IMPORTANT: Please note that you CANNOT override the current status of the hood, from its control panel when you are in Automatic Control. If you attempt to switch the hood off, the hob will turn the hood back on!

If you wish to manually control the hood again and revert to Independent Control, disable the Auto Extraction Control icon and switch off the Hood Connection button on the hob.

In both the automatic modes, and if none of the hob cooking zones are active, the hood will automatically enter Timer Mode after approximately 10 seconds of inactivity and will step down through the power levels one at a time to turn off the hood after a short period. See the Timer section of the hood manual for more details.

NOTE: Whilst the hob is still switched on the On/Off Icon on the hood will blink, but if the hob is switched off during Timer Mode, the Timer Icon on the hood will blink instead and step down through the power levels to turn off the hood as before.

02 Changing the lamp colour and brightness of the cooker hood from the hob

1. Select the Cooker Hood Control Panel from the Main Menu. Touch the Lighting Control Icon to select the brightness control function.

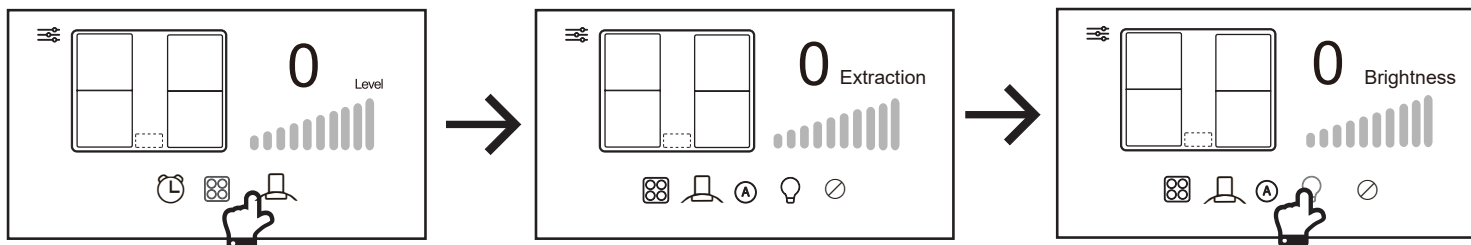

2. Adjust the brightness level by rotating the Slider Control Key between 0-5.

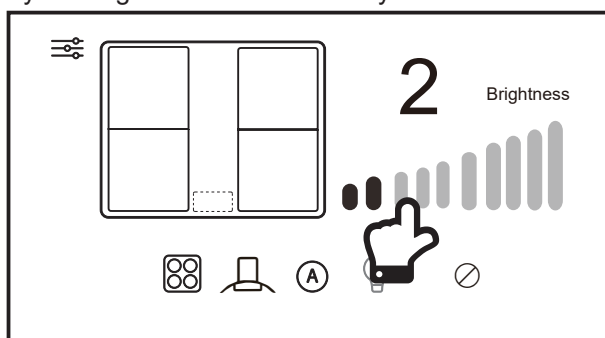

3. You can also adjust the lamp colour temperature by touching the Lighting Control Icon in this sequence:
(a) Blue - Cool White (default).
(b) Orange - Warm White.

Note: You can turn off the lamp by touching the Stop Icon . There will be a slight delay when transmitting this signal to the hood.

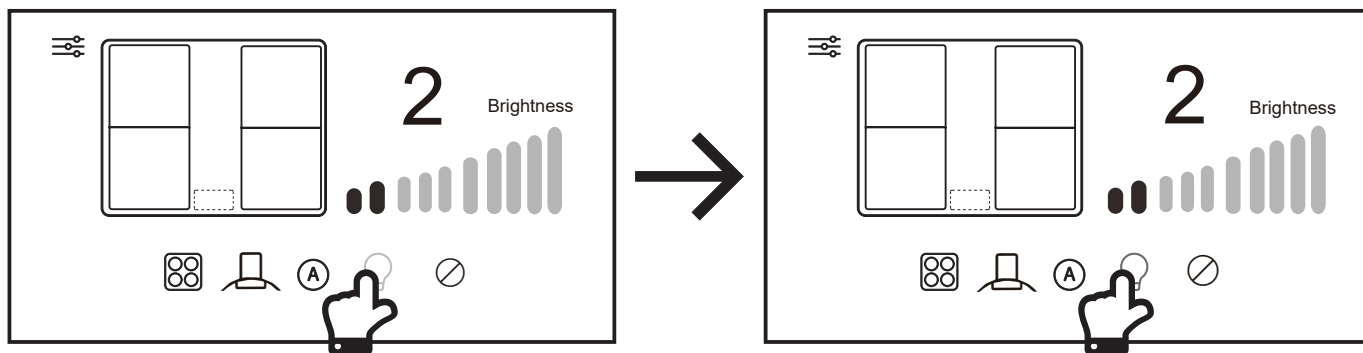

Care & maintenance



WARNING: Always switch off the electricity supply before performing maintenance work. In the event of a fault, contact customer services.



Damaged power cables should be replaced by a competent person or qualified electrician.



For domestic use only.



Never place an empty pan on the hob as this will cause the overheat sensor to switch off the appliance automatically.



When a cooking zone has been on for a long time, the surface remains hot and shows “H” in the display.



If the surface of the hob becomes cracked, do not use, switch off the appliance at the fused spur and contact customer services.



Do not place rough or uneven vessels on the hob, as they could damage the glass surface.



Avoid banging pots and pans down on the hob. The induction surface is tough but not unbreakable.



Do not put detergents or flammable materials beneath the hob.

Care & maintenance

- The appliance should be cleaned after use, allow to cool first!
- The surface of the induction hob should be cleaned as follows:

Type of dirt	Cleaning method	Cleaning materials
Limescale	Apply white vinegar to the surface, then wipe it dry with soft cloth	Special induction cleaner
Burnt-on stains	Clean with damp cloth and dry it with a soft cloth	Special induction cleaner
Light stains	Clean with damp cloth and dry it with a soft cloth	Cleaning sponge
Melted plastics	Use a scraper suitable for induction glass to remove residue	Special induction cleaner



CAUTION: Avoid rubbing with any abrasive or with the base of the pans, etc, as this will wear the markings on the top of the induction hob over time. Clean the induction hob on a regular basis to prevent the build up of food residue.

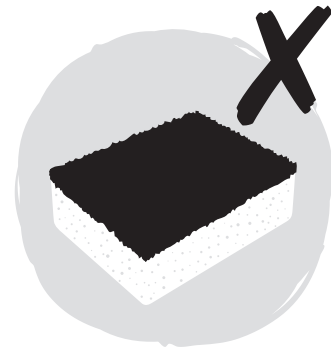
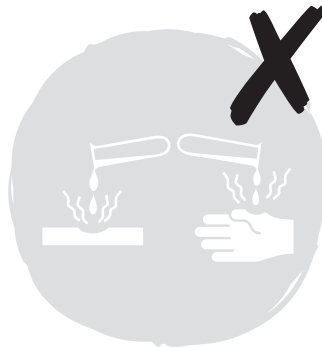

Never use:

- Undiluted washing-up liquid
- Detergent intended for dishwashers
- Scouring agents
- Harsh cleaning agents such as oven spray or stain remover
- Abrasive sponges
- High-pressure cleaners or steam jet cleaners

Care & maintenance

If your hob develops a fault

In the event of a fault, the induction hob will automatically enter safety mode and diagnose the likely issue. The most common error codes are shown below

Error Code	Error Message	Solution
ER03	Water or pan on the Control Panel	Clean the Control Panel or move the pan
E1	Hob has over heated	Allow to cool and restart after 30 minutes
E2	Hob has over heated	Allow to cool and restart after 30 minutes
E3	Abnormal power supply detected (too high)	Ensure the correct power supply is being used
E4	Abnormal power supply detected (too low)	Ensure the correct power supply is being used
E5	Temperature sensor failure Defective cooking zone will display an 'E'	Contact Customer Services
F1, F3, F4	Hardware failure	Contact Customer Services
If the Control Panel overheats it will change colour and sound an audible alarm.		Allow to cool and restart after 30 minutes

Electrical Installation

All installation must be carried out by a competent person or qualified electrician. Before connecting the mains supply ensure that the mains voltage corresponds to the voltage on the rating plate.

Direct Connection

The appliance must be connected directly to the mains using an omnipolar circuit breaker with a minimum opening of 3 mm between the contacts. The installer must ensure that the correct electrical connection has been made and that it complies with the wiring diagram.

The cable must not be bent or compressed. Regularly check the power cord for damage.

WARNING: This is a Class I appliance and MUST be earthed.

This appliance is supplied with a 3 core mains cable coloured as follows:

Brown = L or Live

Blue = N or Neutral

Green and Yellow = E or Earth ⊕

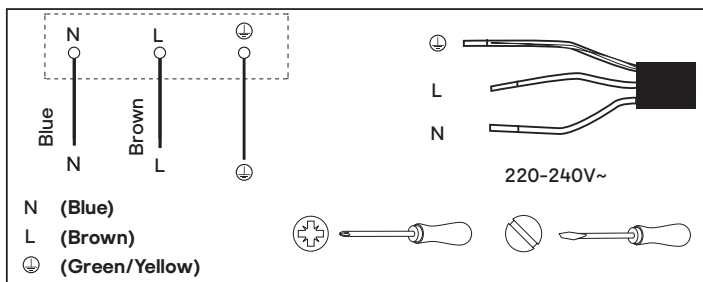

This appliance requires a 40 Amp Residual Current Device (RCD).

To avoid the risks that are always present when you use an electrical appliance it is important that this appliance is installed correctly and that you read the safety instructions carefully to avoid misuse and hazards. Please keep this instruction booklet for future reference and pass it on to any future owners. After unpacking the appliance please check that it is not damaged. If in doubt, do not use the appliance but contact Customer Services.

The manufacturer declines all liability for damage caused to persons and objects due to incorrect or improper installation of the appliance. Any permanent electrical installation must comply with the latest wiring regulations applicable to your country and for your own safety a qualified electrician or contractor should undertake the electrical installation.

Technical Specification

Cooking Hob	ICONTFT60
Cooking Zones	4 Zones
Supply Voltage	220-240V~
Installed Electric Power	7200W
Product Size L×W×H(mm)	590x520x65mm
Building-in Dimensions A×B (mm)	565x495mm

	<p>This appliance is labeled in compliance with European directive 2011/65/EU for Waste Electrical and Electronic Equipment (WEEE). By ensuring that this appliance is disposed of correctly, you will help prevent any possible damage to the environment and to human health, which might otherwise be caused if it were disposed of in the wrong way.</p> <p>The symbol on the product indicates that it may not be treated as normal household waste. It should be taken to a collection point for the recycling of electrical and electronic goods.</p> <p>This appliance requires specialist waste disposal. For further information regarding the treatment, recover and recycling of this product please contact your local council, your household waste disposal service, or the shop where you purchased it.</p> <p>For more detailed information about treatment, recovery and recycling of this product, please contact your local city office, your household waste disposal service or the shop where you purchased the product.</p>
--	---

DISPOSAL: Do not dispose this product as unsorted municipal waste. Collection of such waste separately for special treatment is necessary.

Note: For electrical connection see Technical and legal information section

Customer Service

If your product breaks down. To arrange an in guarantee service call, please contact customer services on the following numbers.

UK and N.Ireland

T: 0344 800 1128 E: uksupport@apelson.co.uk

www.spareszone.co.uk

Republic of Ireland (ROI)

T: 014475261 E: uksupport@apelson.co.uk



Apelson Appliances UK
Ltd Unit 3 Normandy
Landings Pope Street
Castleford
WF6 2AG
United Kingdom
