

ECO MODE CONFIGURATION INSTRUCTION

IMPORTANT: PART FOR QUALIFIED INSTALLERS ONLY.

ECO Mode Configuration

This hob can be connected to a 13,16 or 32Amp supply and configured to work on any of these power settings.

The hob is preset to be connected to a 13Amp supply, all four zones are selected at the same time the hob will limit the maximum power consumed so that the 2.8kW power supply cannot be exceeded. In a similar way, when the hob is connected and configured to a 16/32Amp supply, the hob will limit the maximum power at 3.5/7.0kW.

To change the cable before configuring ECO Mode

Ensure the hob is completely disconnected from the electrical supply!

1. Remove the screw and lift the top cover up.

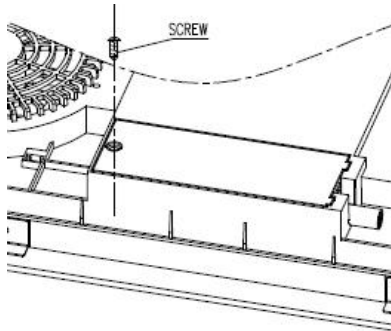

2. Replace the preset 13Amp cable with the 32A cable supplied. (Refer to “Connecting the hob to the mains power supply” in Installation Manual.)

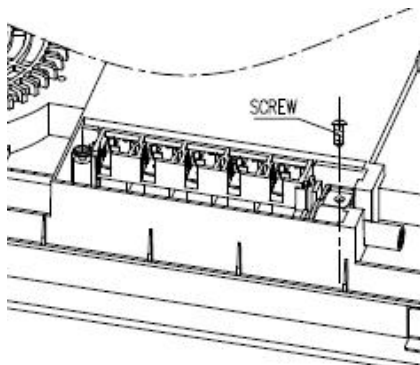

Before configure the ECO mode, Read the Installation Manual especially the “Safety Warnings” section.

The induction hob must be connected to the mains supply only by a suitably qualified electrician.

When selecting a power supply greater than 2.8kW the factory fitted cable must be replaced with the 32Amp cable supplied.

WARNING: If the hob is configured to work at 3.5 / 7.0kW mode and the pre-assembled 13Amp cable & plug is not replaced the power consumption will exceed 2.8kW and will blow the fuse. This may damage the hob & cause other issues.

To configure the hob into ECO Mode

1. Touch ON/OFF key to switch on the power supply. The buzzer beeps once, all displays show “-” and “--”.

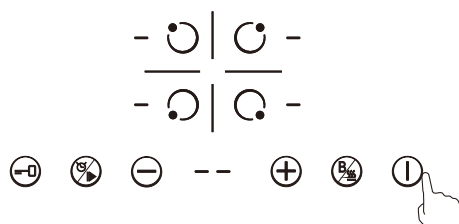

2. Touch front left zone key and timer key simultaneously for 3 seconds. The buzzer beeps indicating that the induction hob enters selection of ECO Mode. At the same time, the timer indicator will display “5”

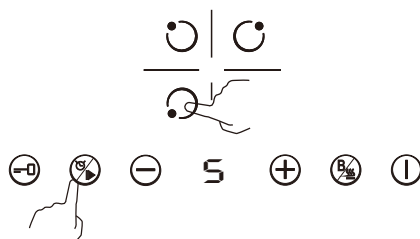

3. Touch timer key, then timer indicator will display “5E”.

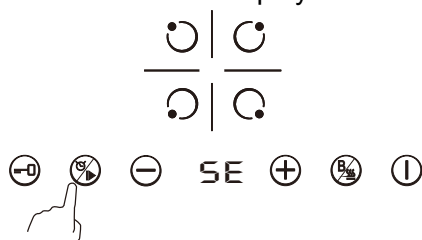

4. Touch front left zone key and timer key simultaneously. The cooking zone A and D indicator will display the current total power.

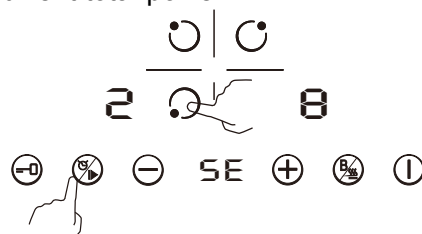

5. Touch front left zone key to switch the total power.

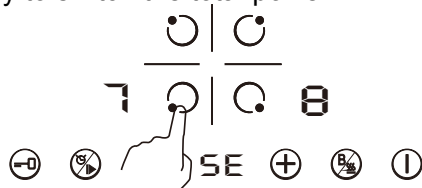

The display zone	ECO power level	Power supply (Fuse protection required)
28	2.8kW	13Amp (BS plug available)*
35	3.5kW	16Amp
70	7.0kW	32Amp

* On first use the power setting is factory set to 2.8kW.

6. Touch the timer key to complete the setting.

