

USER MANUAL

Vertical Glass Hood

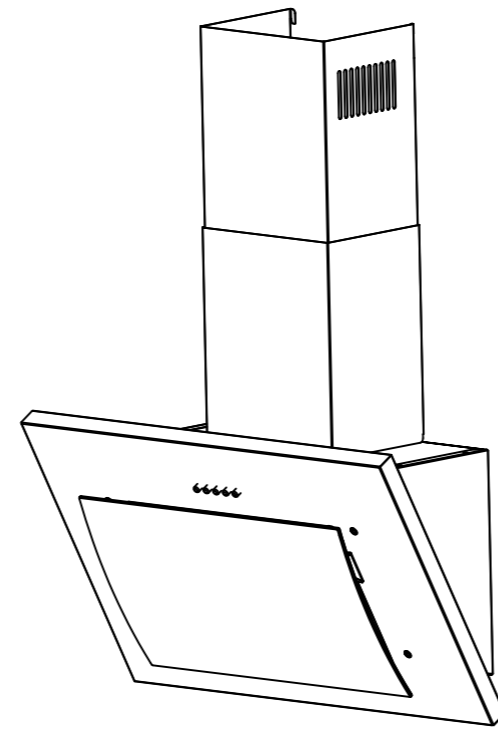

UBLCHH60 Version 00

GB IE

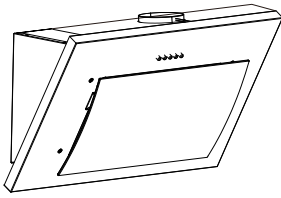

[01] x 1

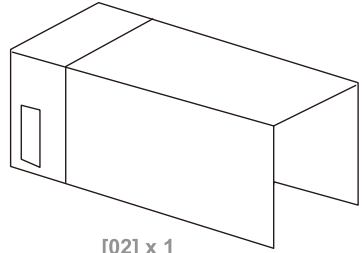

[02] x 1

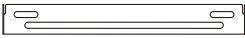

[03] x 1

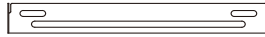

[04] x 1



[05] x 1

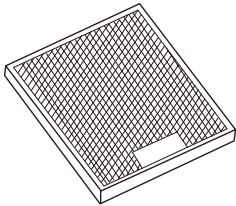

[06] x 1



[07] x 1

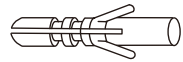

[08] x 9

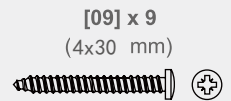

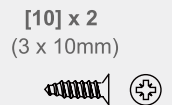

[09] x 9
(4x30 mm)



[10] x 2
(3 x 10mm)

Let's get started...

These instructions are for your safety. Please read through them thoroughly before use and retain them for future reference.

	Getting started...	03
	Safety	04
	Before you start	08
	In more detail...	10
	Product functions	10
	Switching on/off	10
	Care and maintenance	11
	Troubleshooting	13
	Recycling and disposal	14
	Technical and legal information	15
	Appendix	
	Installation	17
	Information for EU66	23

These instructions are for your safety. Please read through them thoroughly prior to installation and retain them for future reference.



- All installation work must be carried out by a competent person or qualified electrician.
- This appliance must be installed correctly by a suitably qualified person, strictly following the manufacturer's instructions.

- This appliance complies with all current European safety legislation, however, the Manufacturer must emphasise that this compliance does not prevent the surfaces of the appliance from heating up during use and remaining hot during its operation.
- Accessible parts may become hot during use. Young children should be kept away. Care should be taken to avoid touching the appliance.
- The Manufacturer highly recommends that this appliance be kept out of the reach of babies and small children.
- This appliance can be used by children aged from 8 years and above and persons with reduced physical, sensory or mental capabilities or lack of experience and knowledge if they have been given supervision or instruction concerning use of the appliance in a safe way and understand the hazards involved. Children shall not play with the appliance. Cleaning and user maintenance shall not be made by children unless they are older than

8 and supervised.

- ✓ Keep the appliance and its cord out of reach of children less than 8 years.
- ✓ Means for disconnection must be incorporated in the fixed wiring in accordance with the wiring rules. An all-pole disconnection switch having a contact separation of at least 3mm in all poles should be connected in fixed wiring.
- ✓ Regularly check the power plug and power cord for damage. If the supply cord is damaged, it must be replaced by the manufacturer, its service agent or similarly qualified persons in order to avoid a danger or injury.
- ✓ Do not allow the electric cables to touch the hot parts of the appliance.
- ✓ Make sure that the power cord is not caught under or in the appliance and avoid damage to the power cable.
- ✓ Do not install the appliance outdoors in a damp place or in an area which may be prone to water leaks such as under or near a sink unit. In the event of a water leak allow the machine to dry naturally.
- ✓ **Warning:** Failure to install the screws or fixing device in accordance with these instructions may result in electrical hazards.
- ✓ **Warning:** When the range hood and appliances supplied with energy other than electricity are simultaneously in operation, the negative pressure in the room must not exceed 4 Pa (4×10^{-5} bar).

Safety

- Please dispose of the packing material carefully.
- Do not use flammable sprays in close vicinity to the appliance.
- We also recommend that great care be taken during use and cleaning. Read the cleaning and maintenance sections for this appliance carefully.
- A steam cleaner is not to be used.
- The appliance is not intended to be operated by means of external timer or separated remote-control system.
- The appliance is for domestic use only.
- Warning:** Consult local regulations regarding fumes outlets. Do not connect the hood to a fume, ventilation or hot air duct. Confirm that room ventilation is appropriate with the local authorities. Make sure the maximum air extraction flow rate for the appliances in the room does not exceed 4 Pa (0.04 mbar). The room must have adequate ventilation if an extractor hood is used simultaneously with appliances that run on gas or other fuels. The air must not be discharged into a flue that is used for exhausting fumes from appliances burning gas or other fuels. Regulations regarding air extraction must be complied with.
- Warning:** Before connecting the hood: switch off the electricity supply and check that the supplied voltage and frequency coincide with that indicated on the appliance nameplate.
- Warning:** The hood may stop working during an electrostatic discharge (e.g. lightning). This

- involves no risk of damage. Switch off the electricity supply to the hood and reconnect after one minute.
- ☑ To avoid the risk of fire, clean the metal filter regularly and closely watch and regulate pans containing hot oil.
 - ☑ Do not use the hood if it shows signs of damage or imperfection. Contact customer services.
 - ☑ Flambe cooking must not be carried out underneath this appliance.
 - ☑ When installing the appliance, make sure that the following distances between the top of cooker or hob and the lowest part of the cooker hood must be observed:
 - > Gas hobs: 650mm.
 - > Electric hobs: 435mm.
 - ☑ The Manufacturer declines all liability for personal or material damage as a result of misuse or incorrect installation of this appliance.
 - ☑ Regarding the information pertaining to installation, thanks to refer to the below paragraph of the manual.
 - ☑ Regarding the information for replacing the bulb, please see section "Care and maintenance".



Warning

There is a risk of electric shock and fire if cleaning is not carried out in accordance with the instructions.

Before you start

Things to check before you start

- To avoid the risks that are always present when you use an electrical appliance it is important that this cooker hood is installed correctly and that you read the safety instructions carefully to avoid misuse and hazards. We recommend that you keep this instruction booklet for future reference and pass it on to any future owners. After unpacking the cooker hood please check that it is not damaged. If in doubt, do not use the appliance but contact Customer Services on 0344 800 1128 (UK) and 01 4475261 (Ireland).
- Check the package and make sure you have all of the parts listed.
- Decide on the appropriate location for your product.
- If this product contains glass please take care with fitting or handling to prevent personal injury or damage to the product.
- This specifications plate is available on this appliance. This plate displays all the necessary identification information for ordering replacement parts.
- If you sell the appliance, give it away, or leave it behind when you move house, make sure you also pass on this manual so that the new owner can become familiar with the appliance and its safety warnings.

You will need

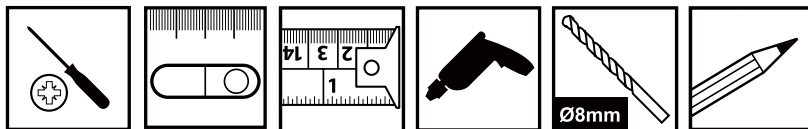

Accessories not supplied

Recirculation

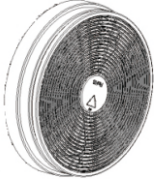

TMFILT1 (UK & IE)



**SELF ADHESIVE
ALUMINIUM TAPE**

Extraction

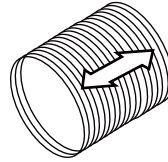

**Ø150mm
VENT PACK 2 (UK & IE)**

**CARBON FILTER ORDERING
HOTLINE
0344 800 1128 (UK)
014475261 (IE)**

Operation

Product functions

- This appliance extracts the air of the kitchen to remove the odours and keep an optimum level of air quality inside the room, it also allows you to illuminate the cooking area.

Switching on/off

- Switch on the appliance at the switched fused connection unit. The appliance is ready for use.

Five-button panel

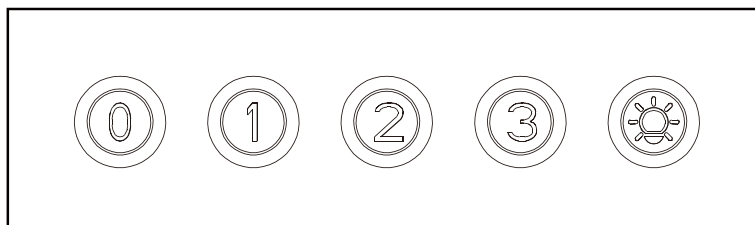

- ① Off button for extractor fan.
- ① Extractor fan speed 1 button.
- ② Extractor fan speed 2 button.
- ③ Extractor fan speed 3 button.
- ☀ On/off button for built-in light.

To obtain the best results from your cooker hood it is recommended that you leave it switched on for 15 minutes after you have finished cooking.

Active charcoal filter replacement



Warning

Always switch off the electricity supply before carrying out maintenance work on the hood. In the event of a fault, contact customer services.

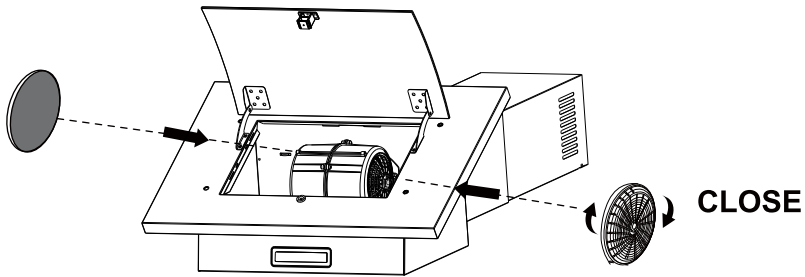
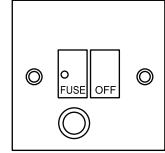

NOTE:

Make sure the filter is securely locked. Otherwise, it would loosen and cause dangerous.

When activated carbon filter attached, the suction power will be lower.

2 X ACTIVE CHARCOAL FILTER (NOT SUPPLIED).
MODEL NUMBER **TMFILT 1**(UK & IE)

CARBON FILTER ORDERING HOTLINE

0344 800 1128 (UK)

014475261 (IE)

Care and maintenance

Aluminium and active charcoal filters replacement



1 MONTH

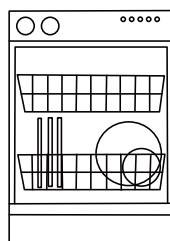
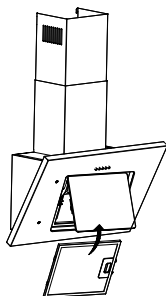

MAX.65°C

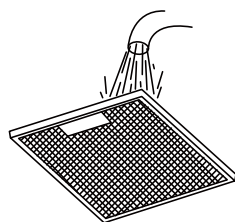

Aluminium filters: To avoid fires, clean thoroughly once a month or whenever the display pilot light lights up (if fitted). To do so, remove the filters and soak in hot water and detergent for an hour. If using a dishwasher, position the filters vertically to improve the cleaning process.

Active charcoal filters:
Replace every 3 months.



3 MONTHS

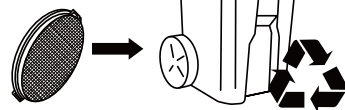
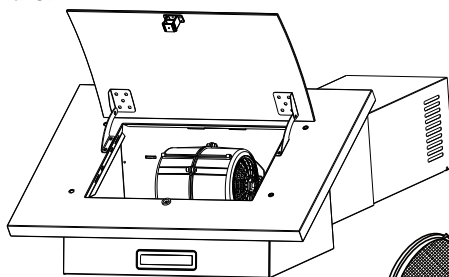

Note: Increase the filter cleaning/replacement frequency if the hood is used for more than 2 hours a day. Always use genuine filters from the manufacturer.

Troubleshooting

Fault	Cause	Solution
Excessive vibration.	The appliance is not installed properly on the brackets.	Take down the appliance and check it is properly fixed.
	The fan blade is damaged.	Switch off the appliance. Repair to be carried out by qualified service personnel only.
	The fan motor is not fixed tightly.	
Light on, but motor does not work.	The fan blade is jammed.	
	The motor is damaged.	
Both light and motor do not work.	Light bulb blown.	Replace with a bulb with correct rating.
	Power connection loose.	Check power supply.
Suction performance reduced.	Speed may be too low.	Select a higher speed.
	Distance between the cooker hood and the hob is too great.	Readjust the distance to: Gas hobs: 650mm Electric hobs: 435mm
	Aluminium grease filter is dirty.	Clean filters. See <i>Care and maintenance</i> section.
	Top vent might be obstructed.	Clear any obstruction.
	Optional vent kit might be twisted.	Ensure that the vent kit is fitted to the manufacturers instructions.
Works normally but cooking smells linger.	Charcoal filter not fitted in recirculation mode or charcoal filter is full of grease.	Fit charcoal filter if recirculating or change the filter. See <i>Care and maintenance</i> section.



NOTE

If the lamp is failed please contact the after-sales care.

Recycling and disposal

Environmental protection

Waste electrical products should not be disposed of with household waste. Please recycle where facilities exist. Check with your Local Authority or retailer for recycling advice.



The symbol on the product or its packaging indicates that this product cannot be treated as normal household waste. This product must be handed over to an electric and electronic equipment collection point for recycling.

On ensuring that this product is disposed of correctly, you will help to avoid possible negative consequences for the environment and public health, which could occur if this product is not handled correctly. To receive more detailed information about recycling this product, contact your local government, domestic waste disposal services or the outlet where the product was bought.

Technical specification

Supply voltage	220-240V~, 50Hz
Power consumption - Fan	65W
Power consumption - Luminary	2 x 1.5W Max
Power consumption - Total	68W
Protection class	I
Light bulb	Max. 1.5W (LED Module)

Wiring

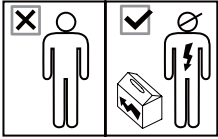

All installation work must be carried out by a competent person or qualified electrician.
Before connecting the mains supply ensure that the mains voltage corresponds to the voltage on the rating plate.



WARNING: THIS APPLIANCE MUST BE EARTHED.

Mains Supply could be connected to the Mains Voltage by Direct Connection

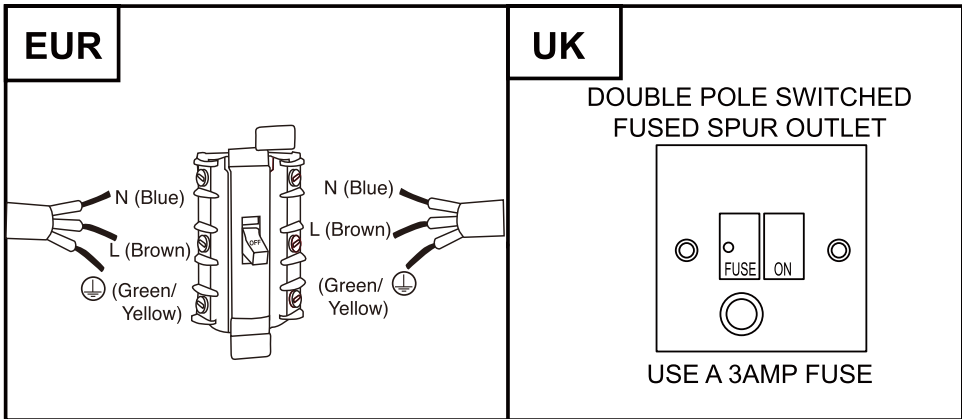

Direct Connection

If the appliance is being connected directly to the mains an omnipolar circuit-breaker must be installed with a minimum opening of 3mm between contacts.

The installer must ensure that the correct electrical connection has been made and that it complies with wiring diagram.

The cable must not be bent or compressed.

Regularly check the power plug and power cord for damage. If the supply cord is damaged, it must be replaced by a special cord or assembly available from the manufacturer or its service agent.

In more detail...

Technical and legal information

The Manufacturer declines all liability for damage caused to persons and objects due to incorrect or improper installation of the appliance.

Electrical Requirements

Any permanent electrical installation must comply with the latest I.E.E. regulations and local electricity company regulations. For your own safety a qualified electrician or contractor who is on the roll of the National Inspection Council for Electrical Installation Contracting (NICEIC) should undertake the electrical installation.

Electrical Connection

Before connecting the mains supply ensure that the mains voltage corresponds to the voltage on the rating plate inside the appliance.



WARNING: THIS APPLIANCE MUST BE EARTHED

The appliance is supplied with a 3-core mains cable and must be connected to the electricity supply via a double pole switch having a 3mm minimum contact gap on each connector.

For UK only

A Switched Fused Connection Unit to BS 1363 Part 4 is recommended.

The fuse must be rated at 3 Amps.

The wires in the mains lead are coloured in accordance with the following code:

Brown = L - Live

Blue = N - Neutral

Green/Yellow = ⊕ - Earth

The connection point must be placed in a position adjacent to the appliance so as to be readily accessible for an engineer in the event of a breakdown.

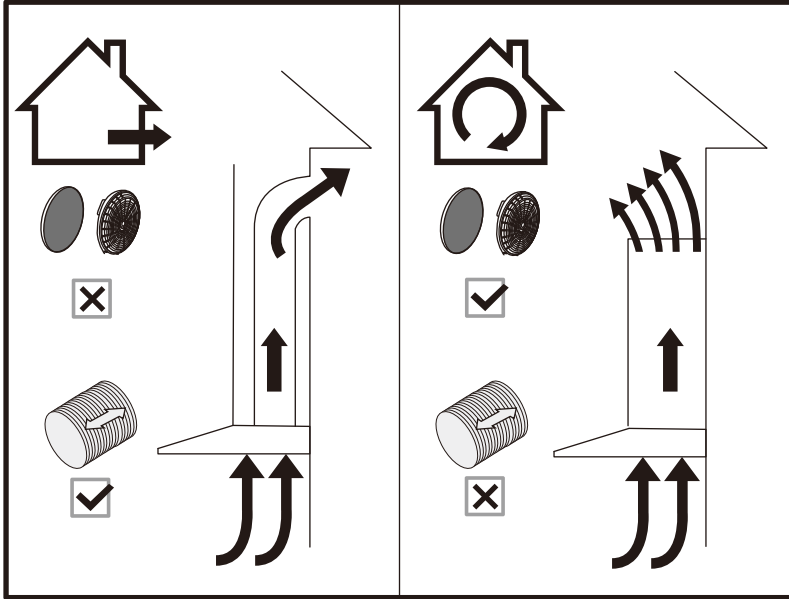

DUCTED OPTION

RECIRCULATION OPTION

You can choose two type of installation:

- Ducted option
- Recirculation option

Warning: Failure to install the screws or fixing device in accordance with these instructions may result in electrical hazards

02

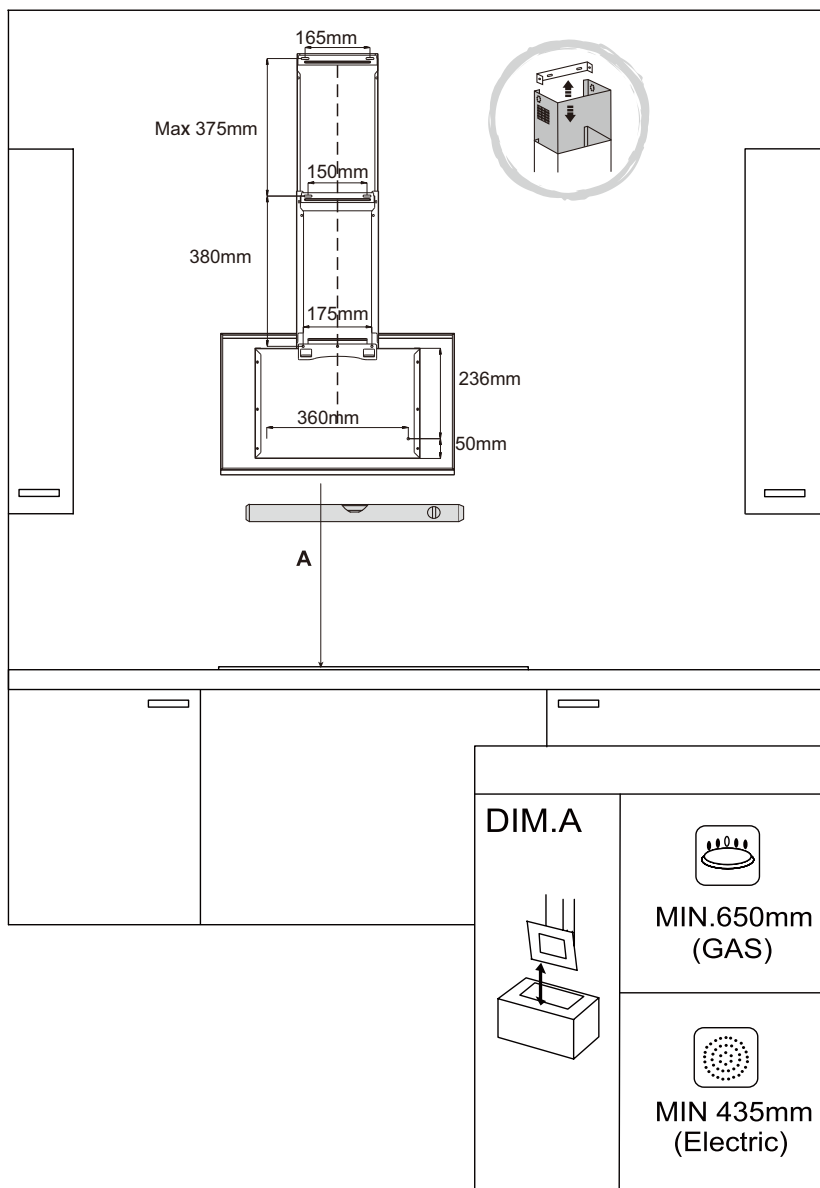

Mark on the wall the hole positions as shown in diagram.



The wall plugs supplied are suitable for solid walls only. When fixing to any other type of wall use suitable alternative fixings.

03

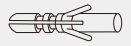

[08] x 9

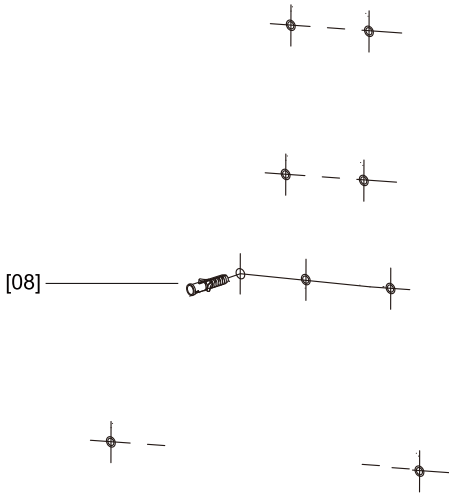

Drill the holes, insert the wall plugs in all 9 holes.

04



[09] x 7



[03] x 1



[04] x 1



[05] x 1

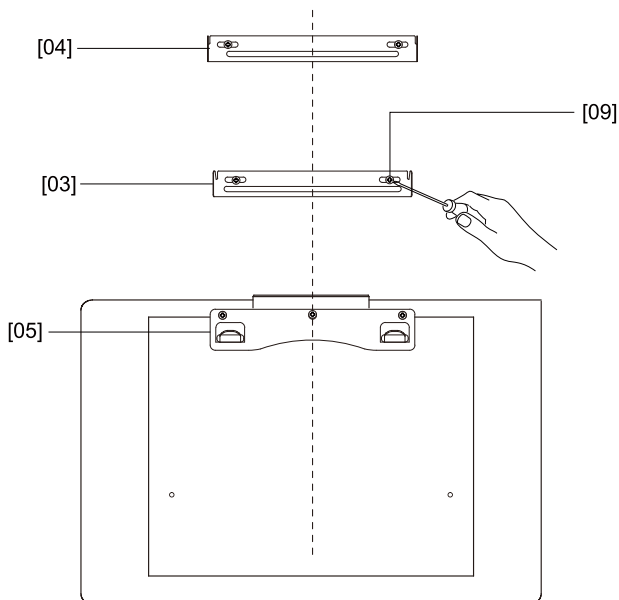

Fix and tighten these brackets onto wall.

05



[07] x 1

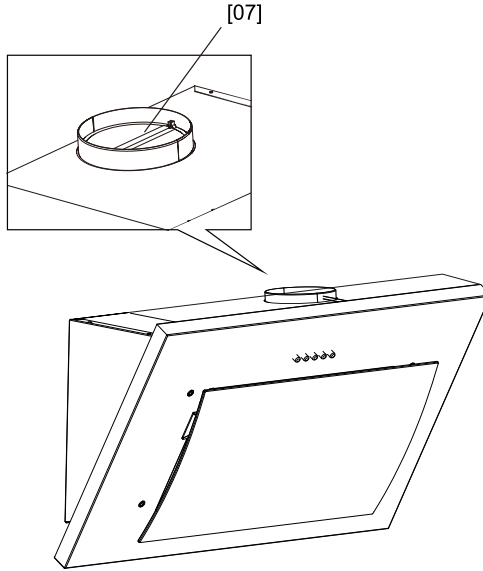

Fix the one-way-valve to the air outlet of the cooker hood.

06



[09] x 2

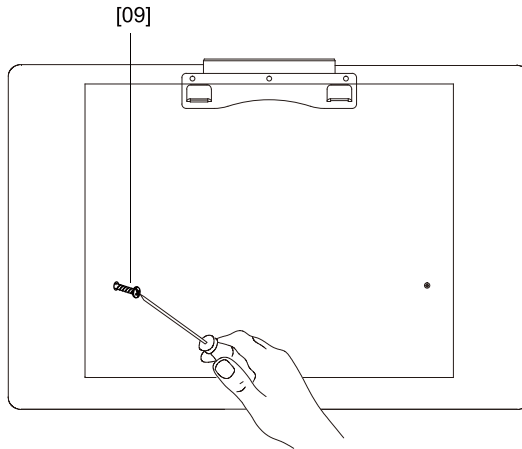

Put up the hood onto the body bracket and remove the aluminium Filter, then fix the bottom screws from inside the hood, tighten them.

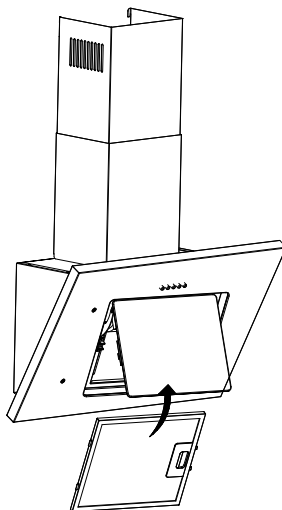

Replace the aluminium Filter

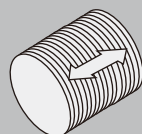
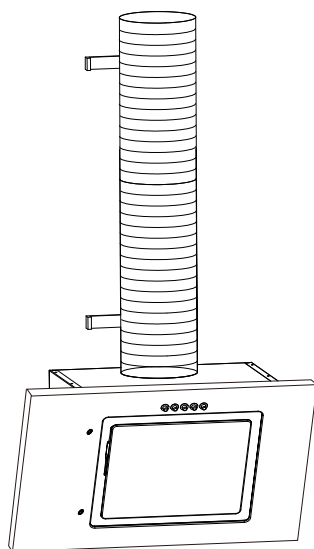

Vent Pack 2
(UK + IE)
x 1



Fix the vent pack using similar tape on the outlet. Only for ducted option.

09

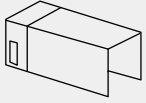

[02] x 1

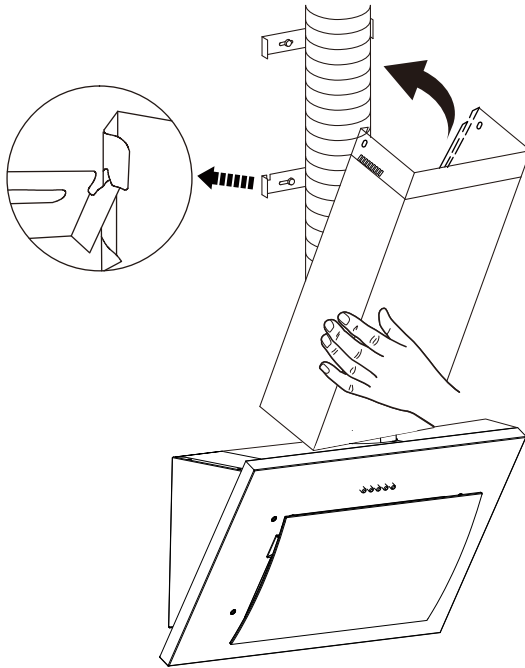

Position the chimney sections, hand the lower chimney cover by matching the both side lock.

10



[10] x 2

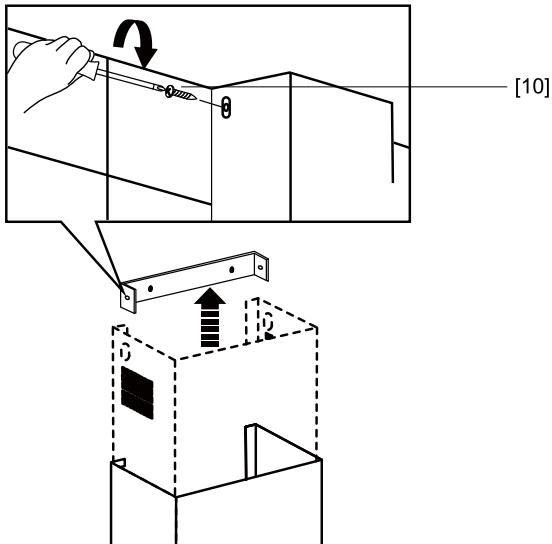

Put up the inner chimney to the top bracket using two screws. Connect top of the ducting tube to vent kit as per manufacturers instructions.

**(A) Information of the cooker Hood**

	Symbol	Value	Unit
Model identification		UBLCHH60	
Annual Energy Consumption	AEC_{hood}	36.8	kWh/a
Time increase factor	f	1.7	
Fluid Dynamic Efficiency	FDE_{hood}	9.6	
Energy Efficiency Index	EEl_{hood}	76	
Measured air flow rate at best efficiency point	Q_{BEP}	169.8	m ³ /h
Measured air pressure at best efficiency point	P_{BEP}	116.4	Pa
Maximum air flow	Q_{max}	290.1	m ³ /h
Measured electric power input at best efficiency point	W_{BEP}	57.3	W
Nominal power of the lighting system	W_L	3.0	W
Average illumination of the lighting system on the cooking surface	E_{middle}	143	lux
Measured power consumption in standby mode	P_s	0.34	W
Measured power consumption off mode	P_o	0	W
Sound power level	L_{WA}	Max.57.9 / min.45.2	dB
Lighting Efficiency	LE_{hood}	47.6	lux/W
Grease Filtering Efficiency	GFE_{hood}	68.73	%
Air flow at min. and max. speed in normal use		Max.289.4 / min.167.2	m ³ /h

The measurement and calculation method of the above table was done in accordance with commission regulation (EU) No 65/2014 & 66/2014.

(B)The following shows how to reduce total environmental impact (e.g. energy use) of the cooking process.

- (1) Install the cooker hood in a proper place where there is efficient ventilation.
- (2) Clean the cooker hood regularly so as not to block the airway.
- (3) Remember to switch off the cooker hood light after cooking.
- (4) Remember to switch off the cooker hood after cooking.

(C)Information for dismantling.

Do not dismantle the appliance in a way which is not shown in the user manual. The appliance could not be dismantled by user. At the end of life, the appliance should not be disposed of with household waste. Check with your Local Authority or retainer for recycling advice.



Apelson Appliances UK Limited
Unit 3 Normandy Landings
Pope St
Castleford
WF6 2AG
