

60cm Side Opening Electric Oven
Model Number SWING60SS
INSTRUCTION MANUAL

USER INSTRUCTIONS

GENERAL WARNINGS

Read carefully all the instructions contained in this booklet. It provides you with important information regarding the safe installation, use and maintenance of the appliance as well as useful advice for getting the best out of your oven. Keep this booklet in a safe place for future reference. After removing the packing, check that the appliance is not damaged in any way.

Be careful not to leave the packing materials (plastic sheeting, expanded polystyrene etc.) where children can get at them, as they can be dangerous.

IMPORTANT: do not use the oven door handle to move the appliance, such as to remove it from the packaging

ATTENTION

- **The oven is an appliance which, for its nature, becomes hot, especially in correspondence of the glass door.**
- **It is therefore a good rule that children do not approach the oven when it is functioning, particularly when the grill is used.**

The first time you switch the oven on, acrid smelling smoke may appear. This is caused by the heating of the adhesive used on the insulation panels surrounding the oven. There is nothing unusual about this. If it happens, simply wait until the smoke disappears before putting any food in the oven. Never roast or bake on the oven base.

Safety is a good habit to get into

- ⊙ This appliance is designed for non-professional, household use and its functions must not be changed.
- ⊙ The electrical system of this appliance may be used safely only when it is correctly connected to an efficient earthing system in compliance with the safety standards currently in effect.
- ⊙ The manufacturer will not be held liable for any damages that might arise out of incorrect installation or improper, incorrect or unreasonable use of the appliance.

The following items are potentially dangerous, and therefore, appropriate measures must be taken to prevent children and the disabled from coming into contact with them:

- Controls and the appliance in general;
- Packaging (bags, polystyrene, nails, etc.);
- The appliance immediately after use of the oven or grill due to the heat generated;
- The appliance when no longer in use (potentially dangerous parts must be made safe).

Avoid the following:

- Touching the appliance with wet parts of the body;
- Using the appliance when barefoot;
- Pulling on the appliance or the supply cord to unplug it from the electrical outlet;
- Obstructing the ventilation or heat dissipation slots;
- Allowing power supply cords for small appliances to come into contact with the hot parts of the appliance;
- Exposing the appliance to atmospheric agents (rain, sun);
- Using the oven for storage purposes;
- Using flammable liquids near the appliance;
- Using adaptors, multiple sockets and/or extension cords;
- Attempting to install or repair the appliance without the assistance of qualified personnel.

WARNING

- Accessible parts will become hot when in use. To avoid burns and scalds children should be kept away
- During usage, the appliance becomes hot, care should be taken to avoid touching heating elements inside the oven.

Qualified personnel must be contacted in the following cases:

- Installation (following the manufacture's instructions);
- When in doubt about operating the appliance;
- Replacing the electrical outlet when it is not compatible with the plug for the appliance.

Service Centers authorized by the manufacturer must be contacted in the following cases:

- If in doubt about the soundness of the appliance after removing it from the packaging;
- If the power supply cord has been damaged or needs to be replaced;
- If the appliance breaks down or functions poorly; ask for original spare parts.

It is a good idea to do as the following:

- Only use the appliance to cook food, nothing else;
- Check the soundness of the appliance after it has been unpacked;
- Unplug the appliance from the electrical mains if it is not functioning properly and before cleaning or performing maintenance;
- When the appliance is not used for an extended period of time, unplug the appliance from the electrical mains.
- Use cooking gloves to place cookware in the oven or when removing it;
- Always grasp the oven door in the centre because the ends may be hot due to the escape of hot air;
- Make sure that the control knobs are on the “o” setting when the appliance is not in use;
- Unplug the appliance when you decide not to use the appliance any longer.

© The manufacturer may not be held responsible for any damage due to: incorrect installation, improper, incorrect and irrational use.

SPECIFICATION

The ovens are designed to operate with a monophase alternating current of 220-240V 50Hz. anyway, before the installation of the appliance, we suggest you to check always these specifications on the rating label applied on the outside rear part.

Powers absorbed in accordance with models		Accessories according to models	
Oven lower heating el. 1200Watt	Oven inside heating el. 1900 Watt	Synchromotor	4 Watt
Oven upper heating el. 1000Watt	Total grill heating el. 1000+1900 Watt	Shaded motor (back)	25 Watt
Oven light 15Watt	Circle heating el. 2100Watt	Shaded motor (top)	15Watt

INDICATOR LIGHTS

The indicator lights situated above the control panel go on and off when the heating elements switch on or off. During the thermostatic functioning of the oven, the neon light remains on until the pre-chosen temperature is reached and when it goes out, this is a sign that the temperature has been reached. When the oven cools, the thermostat switches the heating elements on and off with consequent re-lighting of the indicator lights. In models the internal oven light, which is always on when any function is in operation, is considered as an operation, is considered as an operating warning light.

INSTALLING THE APPLIANCE

IMPORTANT: Unplug your oven before performing installation or maintenance!

Installation should be carried out according to the instructions by a professionally qualified person. The manufacturer declines all responsibility for any damage to persons, animals or things due to a wrong installation.

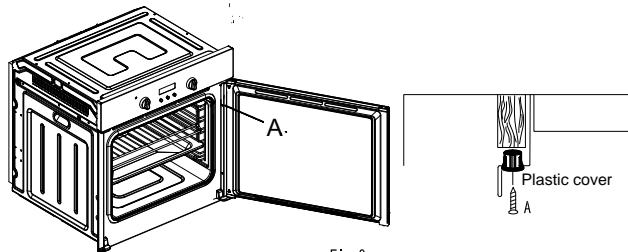

Fitting the appliance

- Fit the appliance into its surround (beneath a work-top or above another appliance) by inserting screws and plastic covers into the 2 holes that can be seen in the frame of the oven when the door is open.
- For the most efficient air circulation, the oven should be fitted according to the dimensions shown in fig. 1-2 of page 2.
- The rear panel of the cabinet must be removed so that air can circulate freely. The panel to which the oven is fitted should have a gap of at least 24 mm at the rear.

NB: where ovens are to be matched with hobs, it is essential to follow the instructions contained in the booklet supplied with the other appliance.

IMPOTANT

- During use the appliance becomes hot, Care should be taken to avoid touching heating elements inside the oven.
- Accessible parts may become hot during use. Yong children should be kept away.
- Do not use harsh abrasive cleaners or sharp metal scrapers to clean the oven door glass since they can scratch the surface, which may result in shattering of the glass.

For a built-in oven to work well the cabinet must be of the right type.

The panels of the adjoining furniture should be heat resistant. Particularly when the adjoining furniture is made of veneered wood, the adhesives should be able to withstand a temperature of 120°C. Plastic materials or adhesives which cannot withstand this temperature will become deformed or unstuck.

To comply with safety regulations, once the appliance has been fitted it should not be possible to make contact with the electrical parts.

All parts which offer protection should be fixed in such a way that they cannot be removed without the use of a tool.

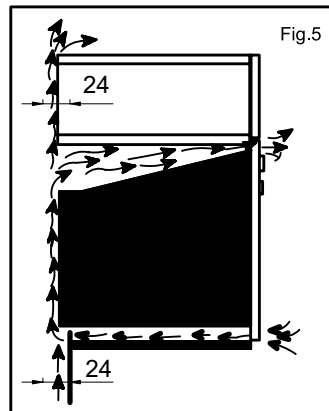
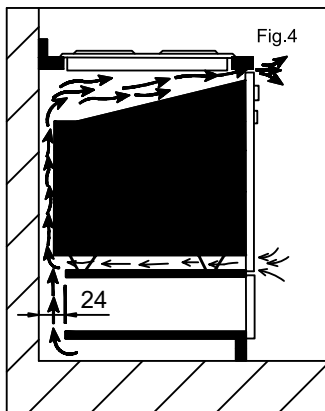

Ensure that the appliance is switched off before replacing the lamp to avoid the possibility of electric shock.

CONNECTION TO THE MAINS SUPPLY

THE APPLIANCE MUST BE CONNECTED IN ACCORDANCE WITH THE RULES CURRENTLY IN FORCE. THE APPLIANCE SHOULD ONLY BE CONNECTED TO THE MAINS ELECTRICAL SUPPLY BY A QUALIFIED ELECTRICIAN.

WARNING: THIS APPLIANCE MUST BE EARTHED

- Check that the power rating of the mains supply and of the sockets are suitable for the maximum power of the appliance as indicated on the specification plate.
- plug should be accessible after installation. Fit the plug into a socket fitted with a third contact which corresponds with the earth connection. This should be properly connected.
- If the appliance just fitted with supply leads but does not come already fitted with a plug, then permanently connect to fixed wiring as follow:

- The “yellow/green” earth wire, which must be connected to terminal, has to be about 10mm longer than the other wires; the “blue” neutral wire has to be connected to the terminal marked with letter N.

“Black, brown, red” live wires have to be connected to terminal L. Mains connection can also be made by fitting a double pole switch with a minimum gap between the contacts of 3mm, proportionate to the load and complying with the regulations in force.

The yellow/green earth wire should not be controlled by the switch.

The plug or a double pole switch used for mains supply connection should be easy to get at, once the appliance is in position.

IMPORTANT :

position the mains supply cable so that it is never subjected to a temperature which is more than 50°C above ambient temperature.

- The electrical safety of the appliance can only be guaranteed when it has been correctly connected to an efficient earthed power supply, as laid down in the regulations for electrical safety.
- The manufacturer cannot be held responsible for any damage to persons or objects due to lack of an earth connection.

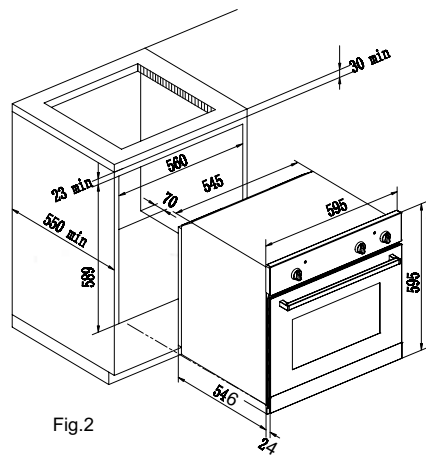

Fig.2

FITTING DIMENSIONS

General tolerance for fitting dimension:

Width: 560 \pm 1,5 mm

Height: 589 \pm 0,2,5 mm

N.B.: ENCASTREMENT POUR PLAQUES A GAZ MOD. (...32..P.....) POLYVALENTES



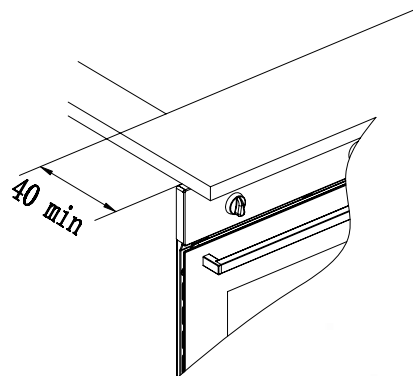

N.B.: BUILDING-IN FOR GAS HOBS MOD. (...32..P.....) POLYVALENTES



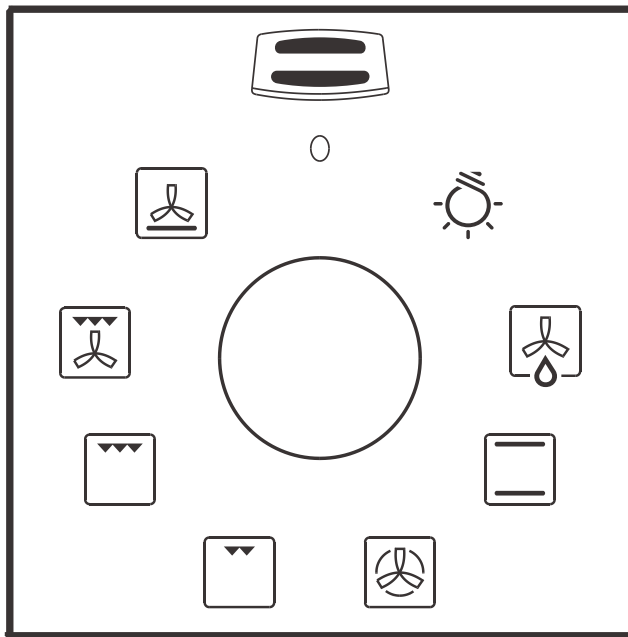









MULTIFUNCTIONAL OVENS 8 FUNCTIONS N.B.:

All functions will start after selecting the temperature with the thermostat knob.



	<p>A light in the Oven.</p>
	<p>Defrosting with fan The air at ambient temperature is distributed inside the oven for defrosting food more quickly and without proteins adulteration.</p>
	<p>Natural convection Both the lower and upper heating elements operate together. This is the traditional cooking, very good for roasting joints, ideal for biscuits baked apples and crisping food. You obtain very good results when cooking on a shelf adjusting the temperature between 50 and MAX°C.</p>
	<p>Fan oven Both the fan and the circular heating element operate together. The hot air adjustable between 50 and MAX°C is evenly distributed inside the oven. This is ideal for cooking several types of food (meat, fish) at the same time without affecting taste and smell. It is indicated for delicate pastries.</p>
	<p>Medium grill It is indicated for grilling and gratinating small quantities of traditional food. This function can be used with closed door for very short times (5-10 minutes). For longer times, this function must always be used with half-open door and control protection in position (see fig. 10-10b).</p>

	<p>Total grill It is indicated for grilling and gratinating traditional food. This function must always be used with half-open door and control protection in position (see fig. 10-10b).</p>
	<p>Total grill heating element  or (turnspit motor  according to the models, see Fig. 11-12). It is indicated for cooking on the spit, grilling and gratinating. This function must always be used with half-open door and control protection in position(see fig. 10-10b).</p>
	<p>Conventional oven with rotisserie A conventional oven works on the principle that heat rises. It is hotter at the top than at the bottom - ideal for cooking meat in different side simultaneously.</p>
	<p>Ventilated Grill Important: do not set thermostat knob (C) to over 175°C. During grilling, keep the oven door closed. All grill components and fan work. In this setting, the central heating elements of the top work. This combination of features compulsory in the air in the oven for the entire cycle of increased non-direct heating elements heat radiation effect. This will allow the heat to penetrate the internal food, and avoid food surface Charred.</p>
	<p>Fan assisted total grill The air which is heated by the grill heating element is circulated by the fan and so helps to distribute the heat between 50 and 200°C. This function can be used for sterilizing glass jars.</p>
	<p>Conventional oven with rotisserie + Fan The heating element surrounds a fan which distributes hot air around the oven. The result is a more even temperature throughout the oven and much faster cooking.</p>
	<p>Lower heating element + Fan The air which is heated by the lower heating element is circulated by the fan and so helps to distribute the heat between 50 and 200°C. This function can be used for sterilizing glass jars.</p>
	<p>Intensive Bake The oven is heated by top and bottom elements and the fan mounted in the back panel helps to distribute heat throughout the oven. Suitable for perfect pastry, no need to blind bake.</p>
	<p>Upper heating and inside heating Series + Lower heating element This function is used multibarreled has also worked, in the gallbladder gave off heat evenly, the energy consumption was low.</p>

Electronic Timer Setting (3 keys) D6 series

Operating instructions for Electronic Timer (3 keys)

Before using for the first time

Setting and changing the current time

i The oven only operates when the time has been set.

When the appliance has been connected to the electrical supply or when there has been a power cut, the function indicator Time ⌚ flashes automatically.

1. To change the time that has already been set, press the Selection ⌚ button repeatedly, until the function indicator Time ⌚ flashes.

2. Set the current time using the Δ or ∇ button

After approx. 5 seconds, the flashing stops and the clock displays the time of day set.

The appliance is now ready to use.

i The time can only be changed if neither of the automatic functions (Cook time ☺ or End time STOP) have been set.

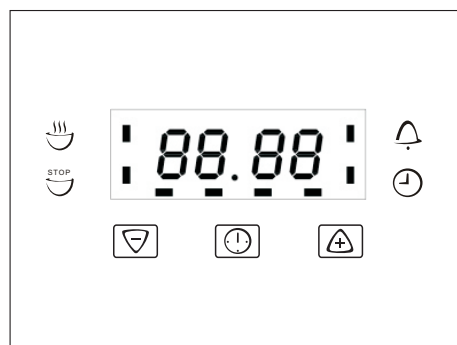
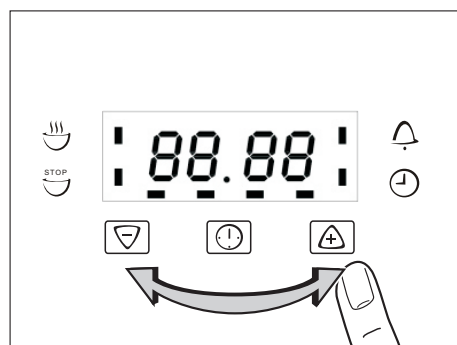
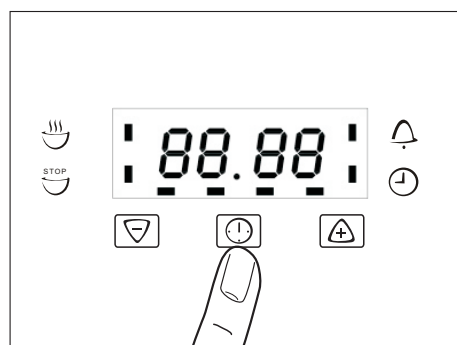

Clock Functions

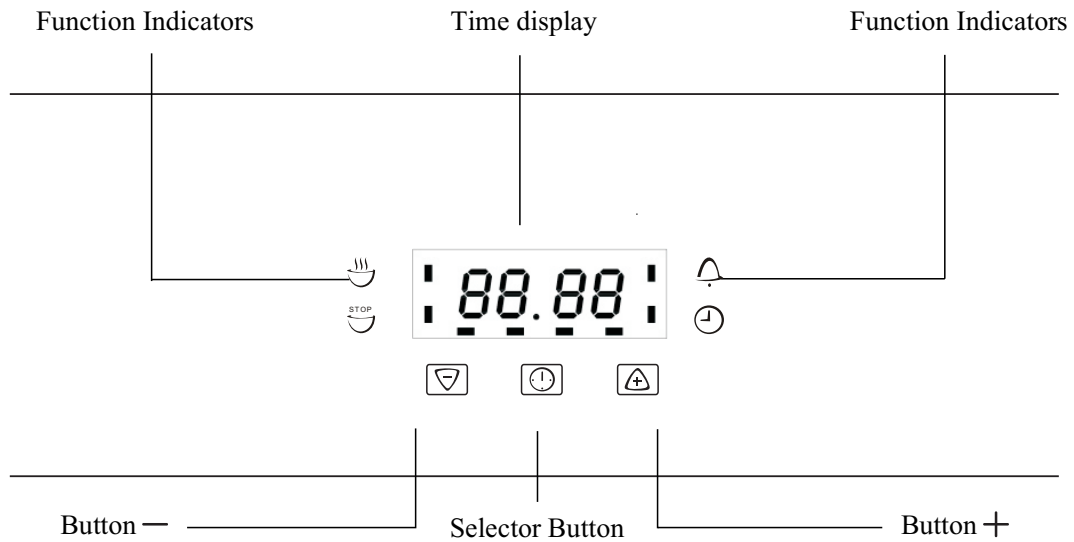

Countdown

To set a countdown, a signal sounds after the time has elapsed.

This function does not affect the operation of the oven.

Cook time

To set how long the oven is to be in use.

End time

To set when the oven is to switch off again.





Time

To set, change or check the time

(See also section “Before Using for the First Time”).



How to use the clock functions

- When a function has been selected, the corresponding function indicator flashes for approx. 5 seconds. During this time the desired times can be set using the  or  button.
- When the desired time has been set, the function indicator flashes for approx. another 5 seconds. After that the function indicator is then lit. The set time begins to run.
- Press any of the buttons to stop the acoustic signal.
- The desired oven function and temperature can be selected before or after the clock functions of Cook time  and End time  are set.
- When the cooking time has ended, turn the oven function and temperature dial back to the OFF position.

Switching off the Time Display



By switching off the time display you can save energy.

Switching off the time display

Hold down any two buttons until the display becomes dark.



Switching on the time display

Hold down any button until the time reappears in the display.



The display can only be switched off if none of the clock functions Cook time  End time 

or Countdown  are in use.

Countdown

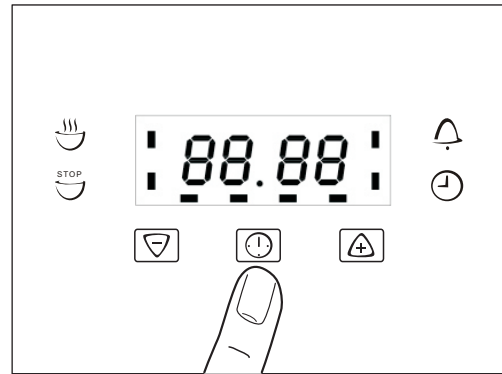
1. Press Selection  button repeatedly, until the function indicator Countdown  flashes.



2. Using the  or  button, set the required Countdown (m ax. 2 hours 30 minutes).

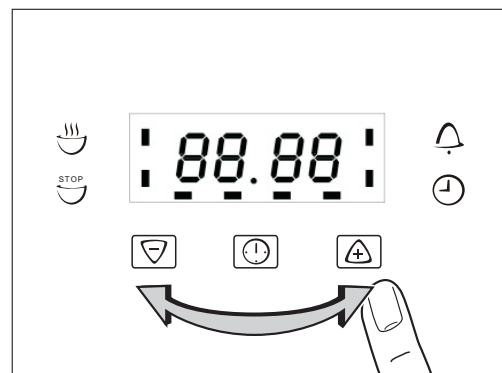

After approx. 5 seconds, the display shows the remaining time.

The function indicator Countdown  will light up.

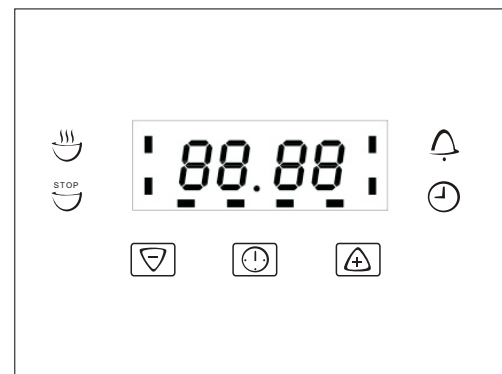



When the time has elapsed, the function indicator flashes and an acoustic signal sounds for 2 minutes.

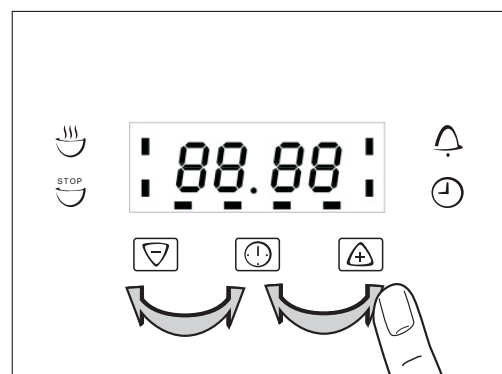

Press any button to switch off the signal.



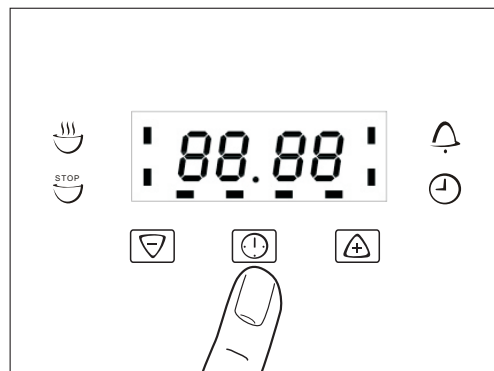

Cook time

1. Press Selection  button repeatedly, until the function indicator Cook time  flashes.

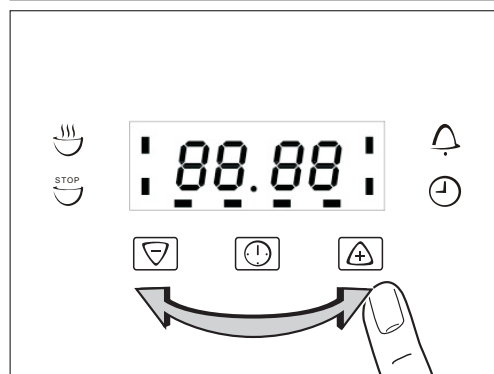

2. Using the  or  button, set the required cooking time.



After approx. 5 seconds, the display returns to the current time. The function indicator Cook time  will light up.

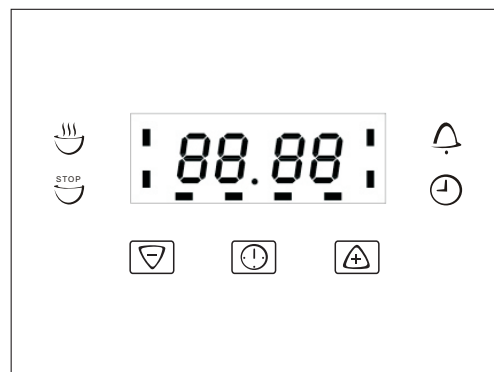



When the time has elapsed, the function indicator will flash, an acoustic signal will sound for 2 minutes and the oven will switch itself off.

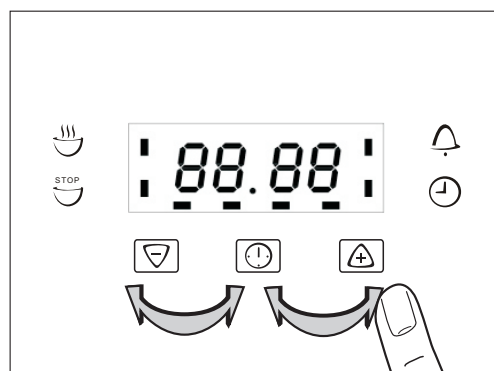

3. Press any button to switch off the signal and the program me.

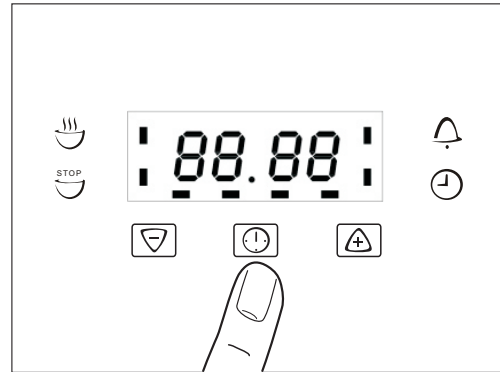

End time

1. Press Selection  button repeatedly, until the function indicator End time  flashes.



2. Using the  or  button, set the required switch-off time.

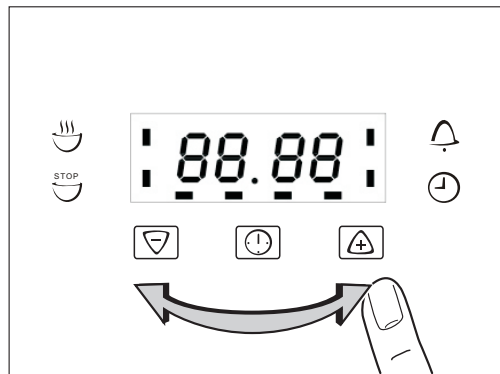

After approx. 5 seconds, the display returns to the current time.

The function indicator End time  will light up.

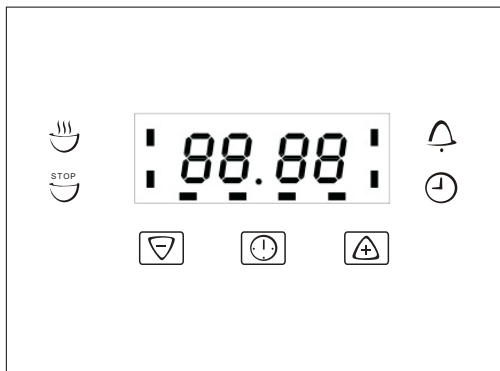

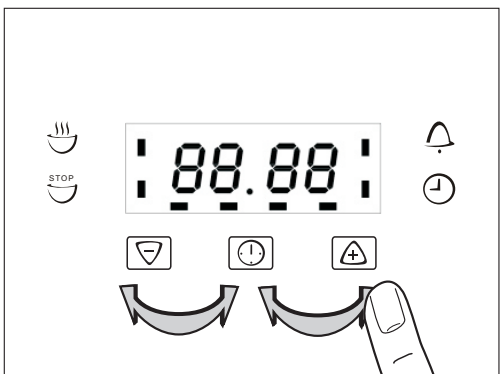

When the time has lapsed, the function indicator will flash, an acoustic signal will sound for 2 minutes and the oven will switch itself off.

3. Press any button to switch off the signal and the program me.





Cook time and End time combined

Cook time  and End time  can be used simultaneously, if the oven is to be automatically switched on and off at a later time.

1. Using the function Cook time  set the Period of time that the dish requires to cook .

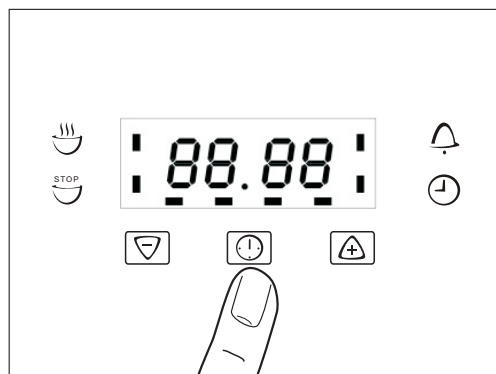

In this example, 1 hour.

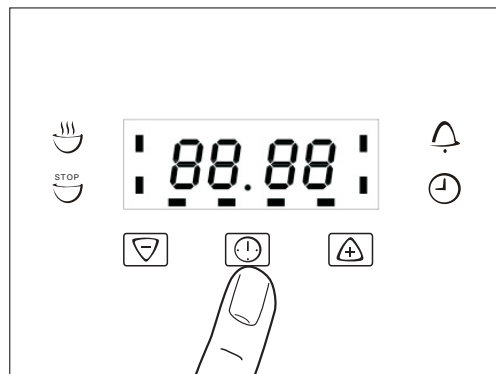

2. Using the function End time , set the time at which the dish is to be ready.

In this example, 14:05.



The function indicators Cook time  and End time  light up and the time is shown in the display.

In this example, 12:05.

The oven will automatically switch itself on at the appropriate time as calculated.

In this example, at 13:05.

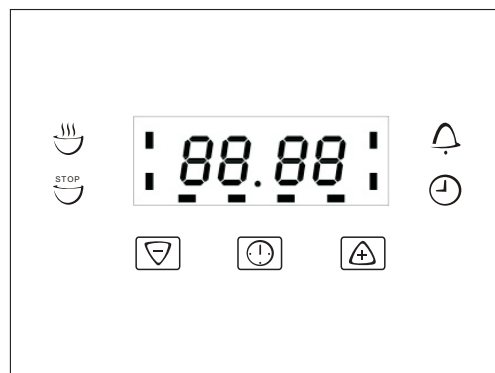

And will switch itself off when the cooking time set has elapsed.

In this example, at 14:05.

How to keep Your Oven in Shape

This appliance is for household use only, don't use it outdoors!

Important: Unplug your oven before cleaning, or performing maintenance!

To extend the life of your oven, it must be cleaned frequently, keeping in mind that:

- ⊙ **Do not uses steam equipment to clean the appliance.**
- ⊙ To protect against the risk of electrical shock, do not immerse the unit, cord or plug in water or other liquid or sprinkle water to clean the appliance!
- ⊙ Don't clean the appliance when it still hot! The inside and external surface of the oven should preferably be cleaned by damp cloth when it is cooled down.
- ⊙ Wash all accessories in hot sudsy water or in a dishwasher, wipe dry with a paper or cloth towel.
- ⊙ If you use your oven for an extended period of time, condensation may form. Dry it using a soft cloth.
- ⊙ There is a rubber seal surrounding the oven opening which guarantees its perfect functioning. Check the condition of this seal on a regular basis. If necessary, clean it and avoid using abrasive products or objects to do so. Should it become damaged, please contact your nearest After-sales Service Centre. We recommend you avoid using the oven until it has been repaired.
- ⊙ Never line the oven bottom with aluminium foil, as the consequent accumulation of heat could compromise the cooking and even damage the enamel.
- ⊙ Clear the glass door using damp cloth and dry it with a soft cloth.

Do not use harsh abrasive cleaners or sharp metal scrapers to clean the oven door glass since they can scratch the surface, which may result in shattering of the glass.

Replacing the Lamp in the Oven

- ⊙ Unplug your oven!
- ⊙ Unscrew the glass cover attached to the lamp holder;
- ⊙ Unscrew the lamp and replace it with another high-temperature lamp (300°C) with the

following characteristics:

- Voltage: AC220V-240V
- Wattage: 15W
- Socket: E 14

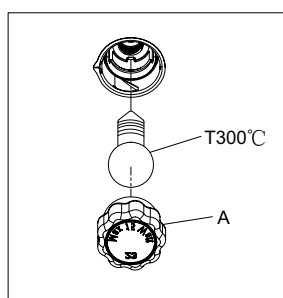

- ⊙ Remount the glass cover and reconnect the appliance to the power supply.

WARNING: Ensure that the appliance is disconnected from the mains electrical supply before replacing the lamp to avoid the possibility of electric shock!

Warning: Do not operate appliance with damaged cord or plug or after the appliance malfunctions, or has been damaged in any manner, return appliance to the nearest Authorized Service Center for examination.

Repair, or adjustment!

USEFUL NOTES FOR COOKING

In the following table, some indicative hints for cooking:

FAULTS	CAUSES	REMEDIES
The upper crust is dark and the lower part too pale	Not enough heat from the bottom	<ul style="list-style-type: none">- Use the natural convection position- Use deeper cake tins- Lower the temperature- Put the cake on a lower shelf
The lower part is dark and the upper crust too pale	Excessive heat from the bottom	<ul style="list-style-type: none">- Use the natural convection position- Use lower side tins- Lower the temperature- Put the cake on a higher shelf
The outside is too cooked and the inside not cooked enough	Too high temperature	<ul style="list-style-type: none">- Lower the temperature and increase the cooking time
The outside is too dry even though of the right color	Too low temperature	<ul style="list-style-type: none">- Increase the temperature and reduce the cooking time.

Protective kit

During operation, the oven glass door and adjacent parts of the appliance become hot. Make sure, therefore, that children do not touch the appliance.

This appliance is not intended for use by persons (including children) with reduced physical, sensory or mental capabilities or lack of experience and knowledge, unless they have been given supervision or instruction concerning use of the appliance by a person responsible for their safety.

Children should be supervised to ensure that they do not play with the appliance.

Side-opening Door Range Door Direction-change procedure

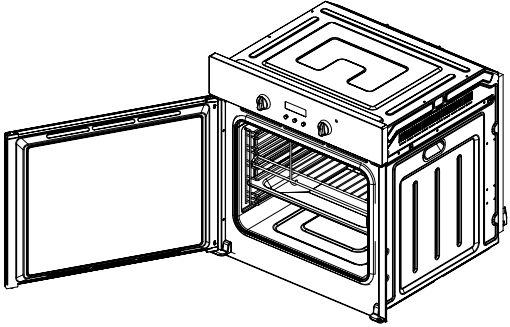
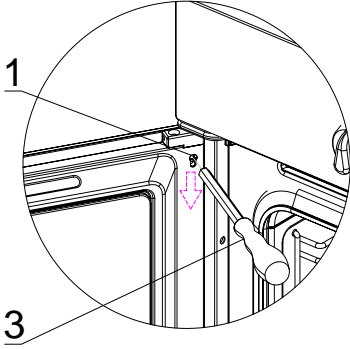
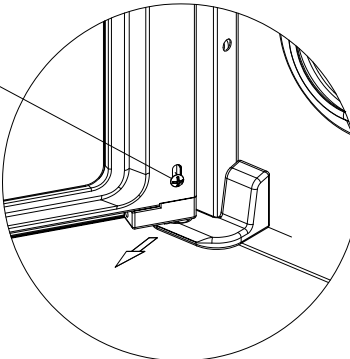
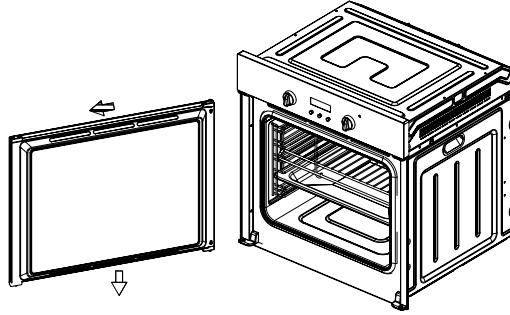
Procedure	Description	Image
1	Open the door to proper angle	
2	Unscrew screw 1 with screwdriver 3, push screw 1 downward, and then pull the door out from up fixed support.	
3	Take the door out from down fixed support directly.	
4	Door is completely taken out from door spindle.	

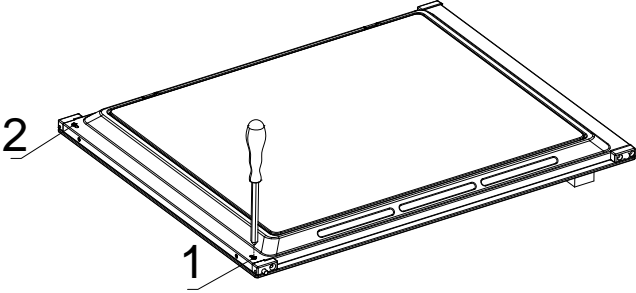
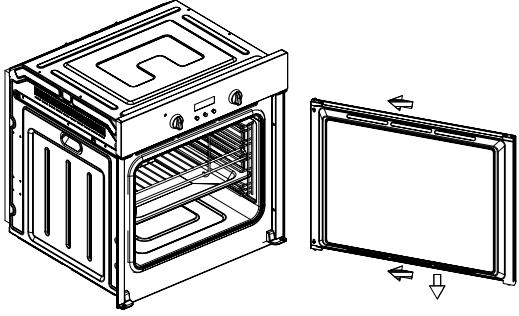
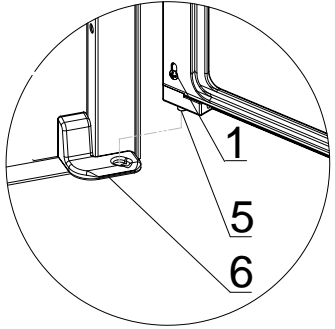
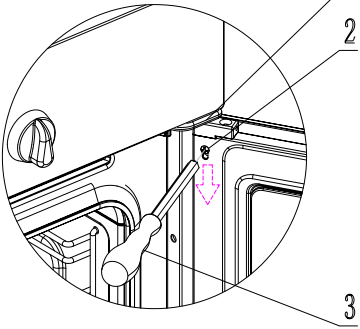
5	Screw up 1 and screw off 2.	
6	Prepare to assemble the door to opposite door spindle. At this moment, screw 1 is downward, screw 2 is upward.	
7	Assemble the door to down fixed support, put fulcrum 5 to down fixed support 6.	
8	Assemble the door to up fixed support, screw up screw 2 with screwdriver 3.	
9	Door direction is completely changed.	