

INSTRUCTION MANUAL - IN-COLUMN WINE COOLER -BUILT-IN WINE COOLER

ART29611



BEFORE USE, PLEASE READ AND FOLLOW ALL SAFETY RULES AND OPERATING INSTRUCTIONS.

Important Safeguards

When using an electrical appliance, basic precautions should always be followed to reduce the risk of fire, electric shock, and injury to persons, including the following:

For Your Safety

Read all instructions carefully, even if you are quite familiar with the appliance.

- The appliance is intended to be used exclusively for the storage of wine.
- Use this appliance only as described in this manual. Other uses not recommended may cause fire, electric shock or personal injury.
- This appliance is not intended for use by young children or infirm persons unless they have been adequately supervised by a responsible person

to ensure that they can use the appliance safely.

- Young children should be supervised to ensure that they do not play with the appliance.
- To protect against the risk of electric shock, DO NOT IMMERSE the unit, cord, or plug in water or spray any other liquid.
- Unplug the appliance from the plug socket when not in use, when moving from one location to another and before cleaning.
- To disconnect the appliance, grip the plug and pull it from the wall outlet. Never pull by the cord.
- Do not operate the appliance in the presence of explosive and/ or flammable fumes.
- Do not place the appliance or any of its part near an open flame, cooking or other heating appliance.
- Do not operate the appliance with a damage cord or plug, if the product malfunctions, or if it is dropped or damage in any manner.
- The use of attachments not recommended by the manufacturer may be hazardous.
- Place the unit on a dry level surface.
- Do not operate if the housing is removed or damaged.
- A loose fit between the AC outlet (receptacle) and plug may cause overheating and a distortion of the plug. Contact a qualified electrician to replace loose or worn outlet.
- Locate the unit away from direct sunlight and sources of heat (stove, heater, radiator, etc.).
- This appliance is CFC- and HFC-free and contains small quantities of Isobutane (R600a), an environmentally friendly coolant.
- You must ensure that the cooling circuit is undamaged when installing the appliance. However, if it becomes damaged, avoid proximity to open fires and heat sources of all kinds. The room in which the appliance is located should be ventilated for a few minutes.

- Never use an appliance with a damaged circuit.
- Ensure that the ventilation openings to and from a built-in appliance are never blocked or covered. No liability will be accepted for any damage incurred owing to misuse of the appliance or as a result of repairs carried out by unqualified personnel. In this case neither the guarantee nor any other liability claims will apply.
- **WARNING:** Do not operate any electrical appliance inside the appliance.
- Do not attempt to repair or replace any part of your appliance unless it is specifically recommended in this manual. All other servicing should be referred to a qualified technician.
- Replace all panels before operating.
- Use two or more people to move and install the appliance. Failure to do so can result in back or other injury.
- Never clean appliance parts with flammable fluids. These fumes can create a fire hazard or explosion. And do not store or use gasoline or other flammable vapors and liquids in the vicinity of this or any other appliance. The fumes can create a fire hazard or explosion.
- Do not connect or disconnect the electric plug when your hands are wet.
- It is recommended that a separate circuit, serving only your appliance be provided. Use receptacles that cannot be turned off by a switch or pull chain.

WARNING: To reduce the risk of fire, electric shock or personal injury, unplug or disconnect the appliance from the power supply before servicing.

- This appliance must not be used by person with affected mental capacities (including children), lack of experience or knowledge, excepting under the supervision of an experimented and responsible person.
- Make sure children do not play with the appliance.

Save These Instructions

If you are experiencing problems, check the Troubleshooting Guide at the back of this manual. It lists causes of minor operating problems that you can correct yourself.

Disposal of Old Appliance

Dispose of your appliance packaging properly.

Refrigeration equipment must be properly disposed of in a way which protects the environment. This applies to your old appliance and to your new unit once it has reached the end of its service life.

WARNING: Please ensure that old, worn appliances are rendered unusable before disposal by removing the plug, cutting the network cable, and removing or destroying any snap fastenings or bolts. You will thus prevent children from locking themselves in the appliance during play (risk of suffocation) or endangering their lives in any other way.

Disposal instructions:

- The appliance must not be disposed of in the dustbin or with normal household rubbish.

- The coolant circuit, particularly the heat exchanger at the back/bottom of the unit, must not be damaged.



- The symbol on the product or its packaging indicates that this product is not to be handled as normal household waste but is to be taken to a recycling collection point for electrical and electronic goods. By correctly disposing of this product you are contributing to the protection of the environment and to the health of your fellow human beings. Improper disposal endangers health and the environment. Further information about the recycling of the product may be obtained from your town hall, refuse collection department or the store where you purchased the product.



Connection to the Mains Supply (Built-in)

Check that the voltage marked on the product corresponds with your supply voltage.

This product is fitted with a 13A plug complying with BS1363. If this plug is unsuitable or needs to be replaced, please note the following:

WARNING:

THIS APPLIANCE MUST BE EARTHED.

Important: The wires in the mains lead are coloured in accordance with the following code:

GREEN/YELLOW - EARTH

BLUE - NEUTRAL

BROWN - LIVE

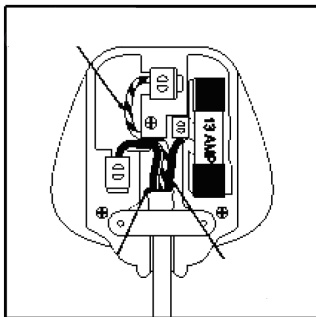

This appliance is equipped with a plug fitted with a 13 amp fuse. Should the fuse fail, then it must be replaced with an ASTA approved fuse (conforming to BS1362) of the same rating. If you need to replace the plug or if the plug is of the incorrect type for

your socket, remove it and replace it with an appropriate type. Dispose of the old plug safely.

As the colors of the wires in the mains lead of this appliance may not correspond with the colored markings identifying the terminals in your plug, proceed as follows: The GREEN/YELLOW wire is the EARTH and must be connected to the terminal which is marked with the letter 'E' or by the earth symbol or colored GREEN or GREEN/YELLOW.

The BLUE wire is the NEUTRAL and must be connected to the terminal which is marked with the letter 'N' or colored BLACK.

The BROWN wire is the LIVE wire and must be connected to the terminal which is marked with the Letter 'L' or colored RED.

Always ensure that the plug cord grip is fastened correctly.

If in doubt consult a qualified electrician who will be pleased to do this for you. This product conforms to EC Directive 92/31 /EEC with respect to Electromagnetic Compatibility.

NON-REWIREABLE MAINS PLUG

If your appliance is supplied with a nonrewireable plug fitted to the mains lead, you will find that it incorporates a fuse, the value of which is indicated either on the base of the plug or on the fuse carrier. Should the fuse need replacing, you must use an ASTA approved one (conforming to BS1362) of the same rating. If the fuse cover is lost, the plug must not be used until a replacement is obtained from an electrical supplier.

If you need to remove the plug, cut it from the mains lead and immediately dispose of it. Never attempt to re-use this plug or insert it into a socket outlet as there is a very great risk of an electric shock.



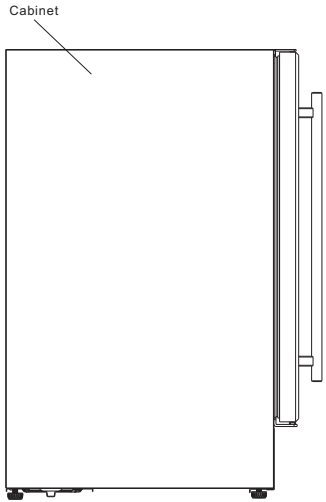
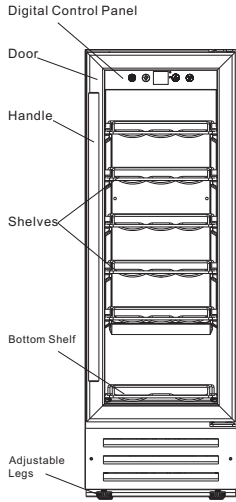

Features of Your Wine Cooler
Model ART29611

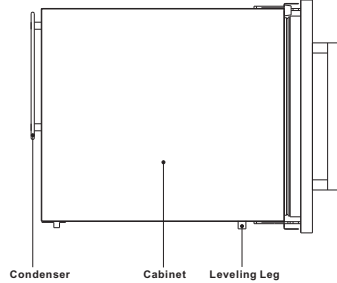
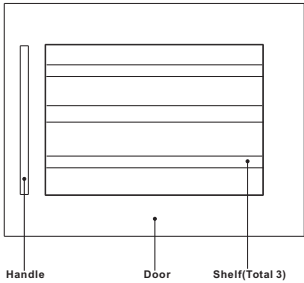

Model ART29611

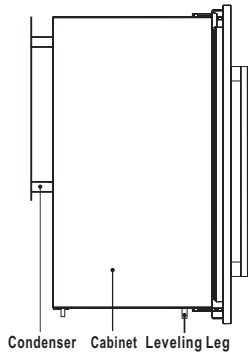
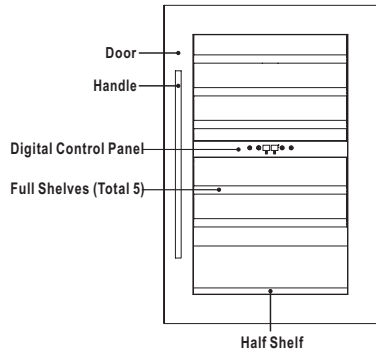

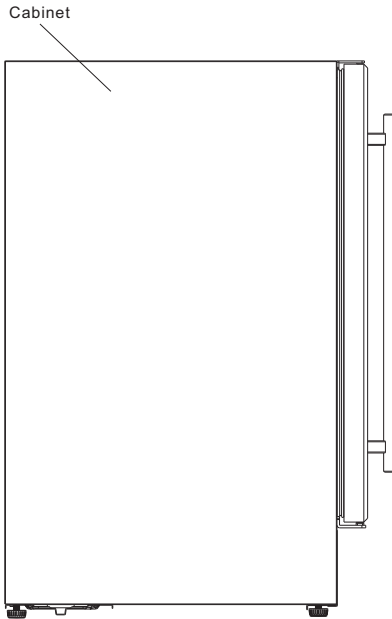
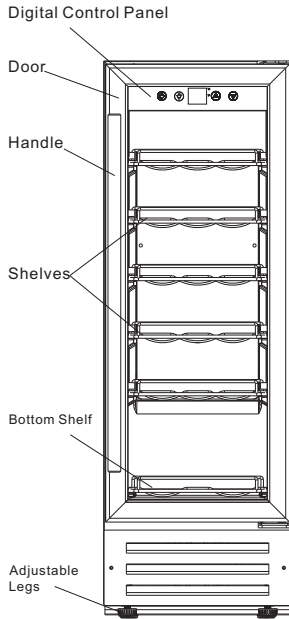

Features of Your Wine Cooler (Built-in)

Installation Instructions

Before Using Your Wine Cooler

- Remove all exterior and interior packing.
- Before connecting the Wine Cooler to the power source, let it stand upright for approximately 2 hours.
- This will reduce the possibility of a malfunction in the cooling system caused by handling during transportation.
- Clean the interior surface with lukewarm water using a soft cloth.
- The door on this appliance can be opened from either the left or the right side. The unit is delivered with the door opening on the left side. Should you wish to open the door from the right, follow the instructions 'Reversing the door swing of your appliance'.

Installation of Your Wine Cooler

- The appliance is designed to be built-in the kitchen cabinets.
- The appliance should be positioned in a well-ventilated, dry room.
- Place your Wine Cooler on a position that is strong enough to support it when it is fully loaded. To level your Wine Cooler, adjust the front leveling legs at the bottom of the Wine Cooler.
- Locate the Wine Cooler away from direct sunlight and sources of heat (stove, heater, radiator, etc.). Direct sunlight may affect the acrylic coating and heat sources may increase electrical consumption. Extreme cold ambient temperatures may also cause the unit not to perform properly.

- Plug the Wine Cooler into an exclusive, easily accessible plug socket. Any questions concerning power and/or earthing should be directed towards a qualified electrician or an authorized products service centre.
- To prevent the appliance from heating up, ensure that an adequate ventilation gap is retained and install a suitable thermal insulation panel. An adequate flow of air to and from the cooling system must be ensured.
- The appliance must be installed to all electrical, plumbing, water and drain connections in

NOTE: Make sure that the socket and ON/OFF switch are easily accessible after the appliance has been installed.

Built-in Cabinet Instructions

The wine cooler door seals the installed unit almost completely, so an air vent must be provided in the base of the housing. Warmed air must be conducted via the ventilation shaft to the rear wall of the housing and then expelled upwards. The ventilation channels should measure at least 200 square centimeters in cross-section.

1. Remove the door gasket on the side you wish to install the handle - you can see two designated holes for handle installation.
2. Install the handle tightly as shown above with two screws, lock washers and flat washers provided.

WARNING: To ensure the proper functioning of the appliance, air vents should never be blocked or covered.

Attention

- Store wine in sealed bottles.
- Do not overload the cabinet.
- Do not open the door unless necessary.
- Do not cover shelves with aluminum foil or any other shelf material which may prevent air circulation.
- Should the wine cooler be left empty for long periods it is suggested that the appliance is unplugged, and after careful cleaning, leave the door ajar to allow air to circulate inside the cabinet in order to avoid possible condensation, mold or odors forming.
- Replace the door gasket.

Installation of Your Wine Cooler Built-in

- The appliance is designed to be built in between (Door) kitchen cabinets and is supplied with adjustable feet that can be altered to fit various worktop heights. This wine cooler is fully compatible with any 600mm deep kitchen unit.
- The air vent at the front of the appliance must never be covered or blocked in any way.
- Avoid locating the unit in damp areas.

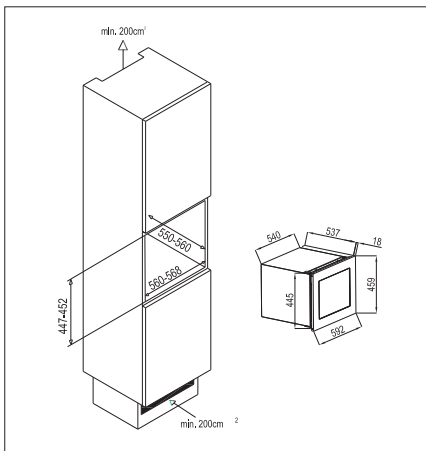
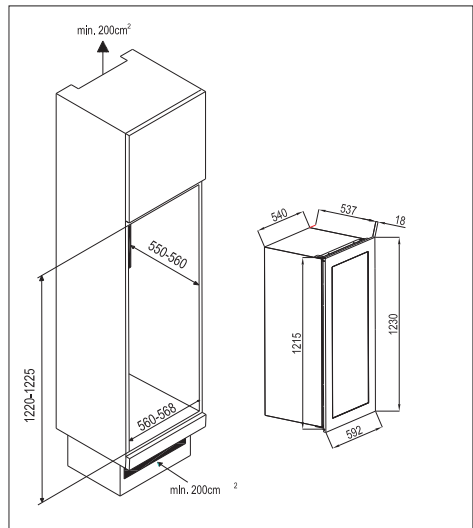
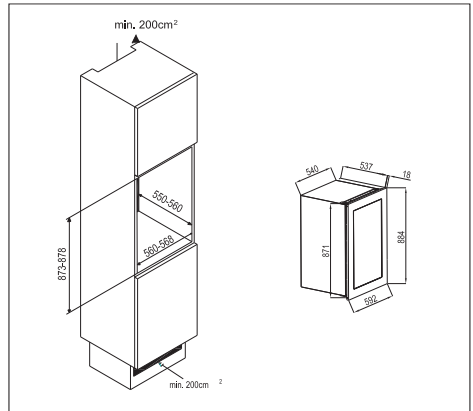

Electrical Connection

Check that the voltage marked on the product corresponds with your supply voltage.

WARNING: Improper use of the grounded plug can result in the risk of electrical shock. If the power cord is damaged, have it replaced by a qualified electrician or an authorized service center. This appliance should be properly grounded for your

safety. The power cord of this appliance is equipped with a plug which mates with the standard grounded outlets to minimize the possibility of electrical shock. Do not under any circumstances cut or remove the ground prong from the power cord supplied. For personal safety, this appliance must be properly grounded.

This appliance requires a standard 220-240 Volt AC ~50Hz electrical ground outlet. Have the wall outlet and circuit checked by a qualified electrician to make sure the outlet is properly grounded. When a standard 2 pins wall outlet is encountered, it is your responsibility and obligation to have it replaced with a properly grounded 3 pins wall outlet.

The cord should be secured behind the appliance and not left exposed or dangling to prevent accidental injury. The appliance should always be plugged into its own individual electrical outlet which has a voltage rating that matches the rating label on the appliance. This provides the best performance and also prevent overloading house wiring circuits that could cause a fire hazard from overheated. Never unplug the appliance by pulling the power cord. Always grip the plug firmly and pull straight out from the receptacle. Repair or replace immediately all power cords

that have become frayed or otherwise damaged. Do not use a cord that shows cracks or abrasion damage along its length or at either end.

When moving the appliance, be careful not to damage the power cord. Electrical fuse protection of at least 10 amperes must be provided. If the socket is no longer accessible once the appliance has been built-in, suitable measures must be taken during electrical installation to ensure that the appliance can be disconnected from the mains.

Do not use your appliance with an extension cord unless this cord has been checked and tested by a qualified technician or service person. The extension cord must be a VED-Listed, 3-wire grounding extension cord that has a grounding plug and outlet and that the electrical rating of the cord is 220-240 volts and at least 10 amperes.

Reversing the Door Swing of Your Appliance

Should you desire to reverse the opening direction, please follow the instructions below.

1. Close the glass door, and remove the decoration plug 2. Unscrew the top hinge pin 3 and lower hinge pin 8. Be careful to support the glass door with hands to prevent it dropping after removing the pins. (Figure 1&2)

2. Pull down to remove the glass door and place it on a padded surface to prevent scratching it.

3. Remove the right top hinge plate 4 by unscrewing the four screws 1 and get the left top hinge plate 6 from the plastic bag that includes the instruction manual then install it at the designated position on the opposite side.(Figure 1)

4. Remove the lower hinge plate 7 by unscrewing the four screws 9. Then turn it around and refit it on the opposite side.(Figure 2)

5. Turn around the glass door 180° and refit the hinge pin 3&8 through the top hinge plate 6 and lower hinge plate 7 into the door. Make sure that the spacers which the hinge pins sit on are correctly positioned.

6. Leveling the door by adjusting the screws that are used to fix the top hinge plate and lower hinge plate.

- | | |
|--------------------------|----------------------|
| 1. Screw | 7. Lower Hinge Plate |
| 2. Decoration Plug | 8. Lower Hinge Pin |
| 3. Top Hinge Pin | 9. Screws |
| 4. Right Top Hinge Plate | 10. Cabinet |
| 5. Glass Door | |
| 6. Left Top Hinge Plate | |

Note: All parts removed must be saved to do the reinstallation of door.

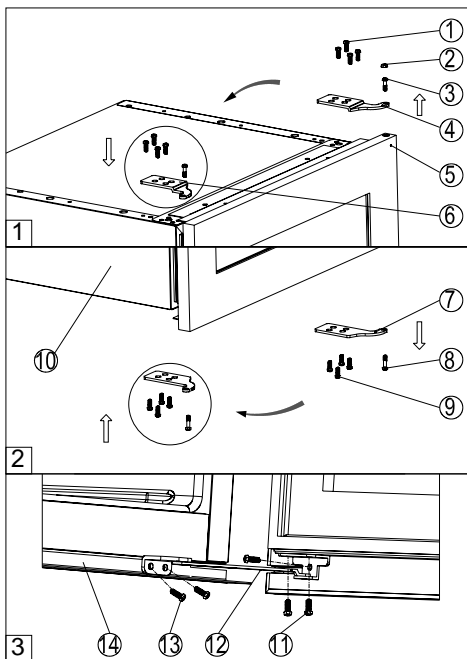

OPERATING YOUR WINE COOLER

The Wine Cooler should be placed in a position where the ambient temperature is between 16-35°C/60-95°F. If the ambient temperature is above or below this range, the performance of the unit may be affected. For example, placing your unit in extreme cold or hot conditions may cause interior temperatures to fluctuate. The range of 5-22°C/40-72°F may not be reached. (In-Column)The range of 5-18°C may not be reached. (Built-in)

Note:

- When you use the Wine Cooler for the first time or restart the Wine Cooler after having been shut off for a long time, there could be a few degrees variance between the temperature you select and the one indicated on the LED readout. This is normal and it is due to the length of the activation time. Once the Wine Cooler is running for a few hours everything will be back to normal.
- If the unit is unplugged, power lost, or turned off, you must wait 3 to 5 minutes before restarting the unit. If you attempt to restart before this time delay, the Wine Cooler will not start.

Use and Control - ART29611

The Controls of Your Wine Cooler



POWER

To control this appliance turn on/off. To turn OFF the appliance, press the  button and hold 5 seconds.

LIGHT

To control the inner light turn on/off.



UP

Used to increase (warm) the set temperature by 1°C/1°F.

DOWN

Used to lower (cool) the set temperature by 1°C/1°F.

°F/°C Selector

Select the temperature display setting in Fahrenheit or Celsius degree. To change the temperature from Fahrenheit to Celsius or from Celsius to Fahrenheit, press the  and  buttons at the same time for 5 seconds.

Setting the Temperature Control



- You can set the temperature as required by pressing the UP or DOWN button. When you press the two buttons for the first time, the LED readout will show the original temperature set previously (the temperature preset at the factory is 12°C/54 °F).
- The temperature will increase 1°C/1°F if you press the UP button once, or the temperature will decrease 1°C/1°F if you press the DOWN button once.
- To view the "set" temperature at any time, press the UP or DOWN button, the "set" temperature will temporarily "flash" in the LED display for 5 seconds.
- The internal storage temperature will appear in blue color in the temperature display window.

USE AND CONTROL – BIWC885

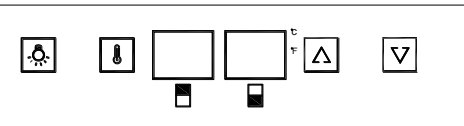
The Controls of Your Wine Cooler



POWER

To control this appliance turn on/off. To turn OFF the appliance, touch and hold the  and  marks at the same time for 5 seconds.

SET

To set or view the internal temperature setting for each zone.

LIGHT

To control the inner light turn on/off.

UP

Used to raise (warm) the set temperature by 1°C or 1°F.

DOWN

Used to lower (cool) the set temperature by 1°C or 1°F.



°F/°C Selector

Select the temperature display setting in Fahrenheit or Celsius degree. To change the temperature from Fahrenheit to Celsius or from Celsius to Fahrenheit, press the  button for 5 seconds.

Setting the Temperature Control

The wine cooler has two temperature zones. The temperature settings of LOWER ZONE and UPPER ZONE are adjustable with the range 5°-22°C/40°-72°F. It is recommended to set the LOWER ZONE to 13-22°C / 55-72°F which is ideal for storing white and red wines and the UPPER ZONE to 5-13°C / 40-55°F which is ideal for storing sparkling and white wines.

NOTE: The temperature set for the LOWER ZONE must always be the same or higher than that in the UPPER ZONE. For optimal performance, the set temperature of the two zones should differ by at least 4°C.

- You can touch **SET** mark to set the internal temperature for each zone. The degrees indicators will appear in the display window marked  for UPPER ZONE and  for LOWER ZONE.
- When you touch the **SET** mark for the first time, the LED readouts will show the original temperature sets previously (the preset temperature at the factory for UPPER ZONE is 10°C / 50°F and for LOWER ZONE is 16°C / 60°F).
- Touch the **SET** mark once. The left LED indicator for UPPER ZONE will flash. Then touch the **UP** or **DOWN** marks to set the desired temperature.
- When you touch the **SET** mark again, the right LED indicator for LOWER ZONE will flash. Then proceed to touch the **UP** or **DOWN** marks to set the desired temperature for the LOWER ZONE.

- The temperature will increase 1°C or 1°F if you touch the **UP** mark once, or the temperature will decrease 1°C or 1°F if you touch the **DOWN** mark once.
- To view the “set” temperature in either zone at any time, touch the **UP** or **DOWN** mark, the “set” temperature will temporarily “flash” in the LED display for 5 seconds. You can touch the **SET** mark to view the temperature setting from one zone to the second zone.

Temperature Display

During normal operation, the temperature display on the control panel shows the temperature inside the appliance. **The temperature display will flash if**

- A different temperature is being set,
- The temperature in the zone deviates by more than 5°C from the set temperature. The temperature display flashing ensures that the temperature can not rise or fall un-noticed and impair the wine.

Use and Control - BIWC1235 The Controls of Your Wine Cooler

Upper control unit



Lower control unit



POWER

To control this appliance turn on/off. To turn OFF the appliance, press the button  and hold for 5 seconds.

LIGHT

To control the inner light turn on/off.

« UP »

Used to raise (warm) the set temperature by 1°C or 1°F.

« DOWN »

Used to lower (cool) the set temperature by 1°C or 1°F

°F/°C Selector

Select the temperature display setting in Fahrenheit or Celsius degree. To change the temperature from Fahrenheit to Celsius

or from Celsius to Fahrenheit, touch and hold button the for 5 seconds.

SETTING THE TEMPERATURE CONTROL

The wine cooler has three temperature zones. The temperature of all zones can be set separately.

The temperature settings of UPPER ZONE are adjustable with the range +14°C et +22°C (+57°F et +72°F), the preset temperature at the factory is 16°C/60°F.

The temperature settings of MIDDLE ZONE are adjustable with the range 5°-11°C/40°-52°F. The preset temperature at the factory is 8°C / 46°F.

The temperature settings of LOWER ZONE are adjustable with the range 11°-13°C/52°-56°F. The preset temperature at the factory is 12°C / 54°F.

Temperature control for upper and middle ZONE at upper control unit. Temperature control for lower ZONE at lower control unit.

- To view the “set” temperature in either zone at any time, touch the UP or DOWN mark, the “set” temperature will temporarily “flash” in the LED display for 5 seconds.

Dynamic Cooling/Silent Modes

This Dynamic Cooling enables the relative humidity inside the unit and the temperature to be distributed evenly around the interior so you can store all your wine under exactly the same excellent conditions. If you would like to use the unit to store wine long term, the dynamic cooling is a must. This will create a continuous climate in the cabinet which imitates that of a wine cellar.

In the Dynamic Cooling, the interior fan will cycle on and off to circulate the inside air. To switch off the Dynamic Cooling, touching and holding the **UP** mark for at least 5 seconds and you can hear “B B B” three sounds and the unit will work in Silent mode. To switch on the Dynamic Cooling, touching and holding the **LOWER** mark for at least 5 seconds and you can hear “B B B B B” five sounds and the unit will work in Dynamic Cooling mode.

Built-in Cabinet Instructions

This unit is designed for both built-in or free standing installation. If you plan to use this unit in a built-in application please follow the requirements shown to the below.

Cabinet Opening Dimensions	
Width	300 mm
Depth	600 mm
Height	875 mm

Figure 1

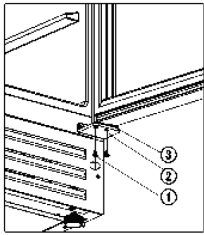

Figure 2

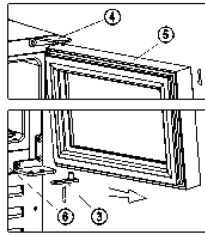

Figure 3

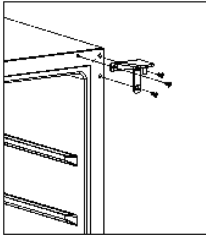
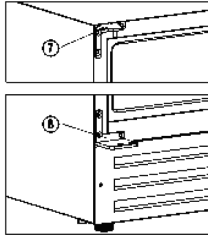

Figure 4



- 1- Lock Screws
- 2- Right Lower Hinge
- 3- Door Shaft Assembly
- 4- Right Top Hinge

- 5- Door
- 6- Cabinet
- 7- Left Top Hinge
- 8- Left Lower Hinge

Installing the Handle

1. Remove the door gasket on the side you wish to install the handle - you can see two designated holes for handle installation.
2. Install the handle tightly as shown above with two screws, lock washers and flat washers provided.
3. Replace the door gasket.

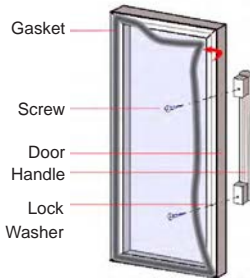

1. Open the glass door and remove the two screws under the right bottom corner of the glass door that are used to hold the right lower hinge to the door shaft assembly. Be careful to support the glass door with hands to prevent it dropping after removing the screws. (Figure 1)

2. Pull down to remove the glass door and place it on a padded surface to prevent scratching it. (Figure 2)

3. Remove the right top hinge and right lower hinge. (Figure 3). Remove the left top hinge and left lower hinge from the plastic bag that includes the instruction manual then install them at the designated positions at the left side of cabinet. (Figure 4)

4. Turn around the glass door 180° and reinstall it.

Temperature Display

During normal operation, the temperature display on the control panel shows the temperature inside the appliance. The temperature display will flash if

- A different temperature is being set,
- The temperature in the zone deviates by more than 5°C from the set temperature. The temperature display flashing ensures that the temperature can not rise or fall un-noticed and impair the wine.

Shelves

- To prevent damaging the door gasket, make sure the door is fully open when pulling shelves out of the rail compartment.
- For easy access to the bottles stored, pull the shelves out approximately 1/3. The shelves are designed with an emergency stop to prevent them being removed too far when loaded.

LOADING

The maximum amount of bottles able to be stored which is given, is only given as an indication, done in factory and is not contractual. This indication (as with the capacity in liters of a refrigerator) is to give a quick estimation of the size of the product. This indication corresponds to tests done with a standard bottle: the bottle type "Bordeaux tradition 75 cl" (the standardized classification contains for each bottle a geographic origin (Bordeaux, Bourgogne, Provence,...), and a type (traditional, heavy, light, flute,...) each with its own specific height and diameter. In fact, one could store more bottles by stacking a single type of bottle and without shelves. But a "varied" cabinet is made up of a large variety of bottles and the "practical" side of the daily use of a cabinet limits the number of bottles stored. Most probably, a few less bottles will be stored than the indicated amount.

For example, if the cellar is filled only with bottles of burgundy, there will be approximately 30% fewer bottles than the initial quantity calculated for Bordeaux. Any added shelf will decrease the loading capacity.

**EXAMPLES OF SERVING TEMPERATURES
(TO BE COMPLIED WITH WHEN TASTING YOUR WINES!)**

Opinions vary as does the ambient temperature but the general consensus is as follows:

Vintage Bordeaux - Reds	16 – 17°C
Vintage Burgundy - Reds	15 – 16°C
Vintage dry white wines	14 – 16°C
Light, fruity, young reds	11 – 12°C
Rosés de Provence, early wines	10 – 12°C
Dry whites and regional red wines	10 – 12°C
Regional white wines	8 – 10°C
Champagnes	7 – 8°C
Sweet wines	6°C

UPKEEP

Before cleaning the cabinet (this must be done regularly), disconnect it either by unplugging it or by removing the fuse.

It is suggested that before first use and then regularly, the cabinet be cleaned both inside and out (front, sides and on top) with a mixture of warm water and gentle cleaning fluid. Rinse with water and let dry completely before reconnecting. Do not use solvents or abrasive products.

Clean the shelves with a gentle detergent then dry with a soft dry cloth.

At the moment of the first use, some odours can persist. In this case, make functioning the appliance at the coldest temperatures, empty, during a few hours. The cold will cancel all these possible odours.

Defrosting

- The unit defrosts automatically.
- The evaporator behind the rear wall of the unit defrosts automatically. The condensate collects in the drainage channel behind the rear wall of the unit, and flows through the drainage hole into the drip tray by the compressor where it evaporates.

Care and Maintenance

Removing Shelves

• To remove any of the shelves from the rail compartment, move the shelf to the position where the notch on the shelf is exactly under the plastic post then lift the shelf to release it. When replacing the shelves, always ensure they are correctly located.

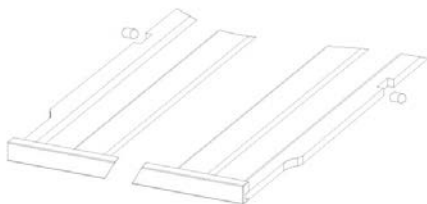

Humidity Control (Optional)

- The wine cooler is equipped with a system for maintaining the correct level of humidity. Fill the small plastic reservoir (humidity box) $\frac{3}{4}$ full with water, and fit onto the runners found on the top shelf of the wine cooler. Check the water level regularly and refill as necessary.
- Please ensure the reservoir is positioned correctly on the runners on the top shelf to avoid the possibility of water spillage.

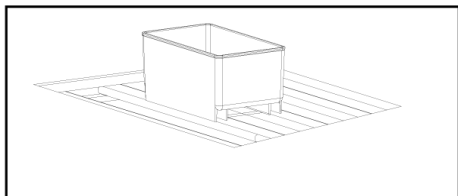

Active Charcoal Filter (Optional)

Replace the active charcoal filter with new one once a year. It can be purchased from your dealer or from the Spare Parts Department.

- Turn the filter 90° clockwise or anti-clockwise. And then remove the filter.
- Insert the new filter with the handle in the vertical position.
- Turn the filter 90° clockwise or anti-clockwise until they click into position.

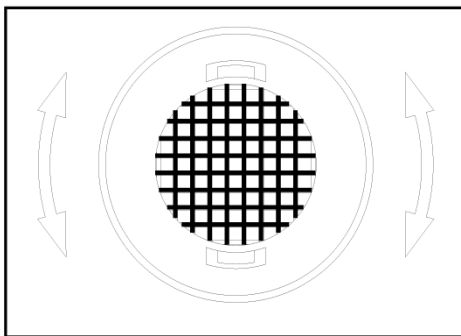

Cleaning Your Wine Cooler

- Turn off the power, unplug the appliance, and remove all items including shelves and rack.
- Wash the inside surfaces with a warm water and baking soda solution. The solution should be about 2 tablespoons of baking soda to a pint of water.
- Wash the shelves with a mild detergent solution.
- Wring excess water out of the sponge or cloth when cleaning any area of the controls.
- Wash the outside cabinet with warm water and mild liquid detergent. Rinse well and wipe dry with a clean soft cloth.

Power Failure

- Most power failures are corrected within a few hours and should not affect the temperature of your appliance if you minimize the number of times the door is opened. If the power is going to be off for a longer period of time, you need to take the proper steps to protect your contents.

Vacation Time

- Short holidays: Leave the Wine Cooler in operation for holidays of less than three weeks.
- Long absences: If the appliance will not be used for several months, remove all items, turn off the appliance and unplug. Clean and dry the interior thoroughly. To prevent odour and mold growth, leave the door open slightly: blocking it open if necessary.

Moving Your Wine Cooler

- Remove all items.
- Securely tape down all loose items (shelves) inside your appliance.
- Turn the adjustable leg up to the base to avoid damage.
- Tape the door shut.
- Be sure the appliance stays secure in the upright position during transportation. Also protect outside of appliance with a blanket, or similar item.

Energy Saving Tips

- The Wine Cooler should be located in the coolest area of the room, away from heat producing appliances, and out of the direct sunlight.
- Ensure that the unit is adequately ventilated. Never cover air vents.
- Only open the door for as long as necessary.

IN CASE OF BREAKDOWN

Despite the care we bring to our production, a breakdown can never be totally excluded. Before contacting the After-Sales department of your store, please check:

- the cabinet is properly plugged in
- there is not a power outage
- the fault does not have as an origin one of those described in the following table

WARNING ! Unplug the cabinet before cleaning or repairing the cabinet !

ENVIRONMENT

This product is in conformity with the EU Directive 2002/96/CEE.



The symbol of the crossed out trash container on the cabinet indicates that this product should be, at the end of its useful life, treated separately from general domestic waste..

It should therefore be taken to an appropriate collection center for electrical and/or electronic appliances or, if you have purcha-

Problems with Your Wine Cooler

You can solve many common Wine Cooler problems easily, saving you the cost of a possible service call. Try the suggestions below to see if you can solve the problem before calling customer service.

PROBLEM	POSSIBLE CAUSE
Wine Cooler does not operate.	Not plugged in. The appliance is turned off. The circuit breaker tripped or a blown fuse.
Wine Cooler is not cold enough.	Check the temperature control setting. External environment may require a higher setting. The door is opened too often. The door is not closed completely. The door gasket does not seal properly.
Turns on and off frequently.	The room temperature is hotter than normal. A large amount of contents has been added to the Wine Cooler. The door is open too often. The door is not closed completely. The temperature control is not set correctly. The door gasket does not seal properly.
The light does not work.	Not plugged in. The circuit breaker tripped or a blown fuse. The light switch is "OFF".
Vibrations.	Check to assure that the Wine Cooler is level.
The Wine Cooler seems to make too much noise.	The rattling noise may come from the flow of the refrigerant, which is normal. As each cycle ends, you may hear gurgling sounds caused by the flow of refrigerant in your Wine Cooler. Contraction and expansion of the inside walls may cause popping and crackling noises. The Wine Cooler is not level.
The door will not close properly.	The Wine Cooler is not level. The door was reversed and not properly installed. The gasket is dirty. The shelves are out of position.
Display "EL" or "EH".	The air temperature sensor is failed.

sed an equivalent product to the store where the new appliance has been bought. The user is responsible for making sure that the appliance is given to the appropriate structure. A selective collection with the aim to recycle, treat or eliminate the appliance in an environmentally friendly fashion contributes to avoid the possible negative effects on the environment, on health and contributes to the recycling of materials of which the appliance is made.

For more detailed information, on the recycling opportunities, please contact your local office of the environment or the store in which the appliance was bought.

WARNING

As we wish to continually improve our products, we reserve the right to modify certain technical characteristics without prior notice.

The warranties for our products are exclusively given by the distributors whom we have chosen. No part of the information herein can be interpreted as an additional guarantee.

CLIMADIF cannot be held responsible for any technical errors or omissions or errors or omissions in this text.