

User Manual for your

UBVFA060SS

NOTE: *This User Instruction Manual contains important information, including safety & installation points, which will enable you to get the most out of your appliance. Please keep it in a safe place so that it is easily available for future reference; for you or any person not familiar with the operation of the appliance.*

Contents

Environmental note	3
Important safety information	4 - 6
Specifications	7 - 9
Product and aperture dimensions	7
Product specifications	7
Standard accessories	7
Electrical details	8
Cooling fan	8
Control panel	9
Oven programmer/timer display	9
Setting and using the oven programmer/timer	10-14
Selecting manual operation mode	10
Setting clock (the time of day)	10
The oven timer	10
Before first use	10
Setting the minute minder function	11
Setting the duration function	11
Setting the end cook function	12
Setting the start and end time function	13
Selecting a cooking function and temperature	15 - 18
Selecting an oven function	15
Oven functions	15
Thermostat control knob	16
Oven operating light	16
Cooking guidelines	16
Warnings	17
Shelf positions	18
Cleaning and maintenance	19-22
Replacing the oven bulb	20
Removing the oven door for cleaning	21
Removing the inner door glass for cleaning	22
Installation	22 - 25
Electrical connection	23
Installing the oven into the kitchen cabinet	24
Positioning the appliance	24
Ventilation requirements	25
My appliance isn't working correctly	26 - 27

Environmental note

This appliance is marked according to the European directive 2002/96/EC on Waste electrical and Electronic Equipment (WEEE). By ensuring this product is disposed of correctly, you will help prevent potential negative consequences for the environment and human health, which could otherwise be caused by inappropriate waste handling of this product.

The symbol  on the product, or on the documents accompanying the product, indicates that this appliance may not be treated as household waste. Instead it shall be handed over to the applicable collection point for the recycling of electrical and electronic equipment.

Disposal must be carried out in accordance with local environmental regulations for waste disposal.

For more detailed information about treatment, recovery and recycling of this product, please contact your local city office, your household waste disposal service or the shop where you purchased the product.



- The packaging materials that the manufacturer uses are environmentally friendly and can be recycled.
- Please discard all packaging material with due regard for the environment.

IMPORTANT SAFETY INFORMATION



Your safety is of the utmost importance to us. Please make sure that you read this instruction booklet **before** attempting to install or use the appliance. If you are unsure of any of the information contained in this booklet, please contact the Customer Care Department.

General Information

- This appliance is designed for domestic household use and can be built into a standard kitchen cabinet or housing unit.
- **IMPORTANT:** *The adjacent furniture or housing and all materials used in the installation **must** be able to withstand a minimum temperature of 85°C above the ambient temperature of the room it is located in, whilst in use.*
- Certain types of vinyl or laminate kitchen furniture are particularly prone to heat damage or discolouration at temperatures below the guidelines given above.
- Any damage caused by the appliance being installed in contravention of this temperature limit, or by placing adjacent cabinet materials closer than 4mm to the appliance, **will be the liability of the owner.**
- The use of this appliance for any other purpose or in any other environment without the express agreement of the manufacturer will invalidate any warranty or liability claim.
- Your new appliance is guaranteed against electrical or mechanical defects, subject to certain exclusions that are noted in the manufacturer's Conditions Of Guarantee. The foregoing does not affect your statutory rights.
- **Repairs may only be carried out by service engineers that are approved by the manufacturer.**

Warning and safety instructions

- This appliance complies with all current European safety legislation. The manufacturer does wish to emphasise that this compliance does not remove the fact that the appliance surfaces ***will become hot during use and retain heat after operation.***
- This appliance is not intended for use by persons (including children) with reduced physical, sensory or mental capabilities, or lack of experience and knowledge, unless they have been given supervision or instruction concerning use of the appliance by a person responsible for their safety.

Child Safety

- We strongly recommend that babies and young children are prevented from being near to the appliance and not allowed to touch the appliance ***at any time.***
- If it is necessary for younger family members to be in the kitchen, please ensure that they are kept under close supervision at all times.

General Safety

- ***Do not*** place heavy objects on the oven door or lean on the oven door when it is open, as this can cause damage to the oven door hinges.
- ***Do not*** leave heated oil or fat unattended, as this is a fire risk.
- ***Do not*** place pans or baking trays directly on the base of the oven cavity, or line it with aluminium foil.
- ***Do not*** allow electrical fittings or cables to come into contact with areas on the appliance that get hot.
- ***Do not*** use the appliance to heat the room it is located in or to dry clothing.
- ***Do not*** install the appliance next to curtains or soft furnishings.

- **Do not** attempt to lift or move cooking appliances by using the oven door or handle, as this may cause damage to the appliance or result in injury to the person lifting the appliance.

Cleaning

- Cleaning of the oven should be carried out on a regular basis.
- Great care should be taken whilst using this appliance and when following the cleaning procedure.
- **IMPORTANT:** *The appliance must be disconnected from the mains before following the cleaning procedure.*

Installation



This appliance must be correctly installed by a suitably qualified person, strictly in accordance with the manufacturer's instructions.

- ***The manufacturer declines any responsibility for injury or damage, to person or property, as a result of improper use or installation of this appliance.***
- Heat, steam and moisture will be created during use of the appliance, take care to avoid injury and ensure that the room is adequately ventilated. If the appliance is going to be used for prolonged periods of time, then additional ventilation may be required.
- Please consult with your qualified installer if you are in any doubt about the amount of ventilation that you will require.

Declaration of conformity

This appliance complies with the following European Directives:

- 2014/35/EU regarding "low voltage"
 - 2014/30/EU regarding "electromagnetic disturbances"
 - Regulation (EC) N° 1935/2004 regarding "materials in contact with food"
-
- o The above directives comply with 93/68/EEC regarding CE marking.
 - o The manufacturer declares that the oven is built using certified materials and requires the appliance to be installed in accordance with the standards currently in force. This appliance must be used by a trained person for domestic purposes only.

Specifications

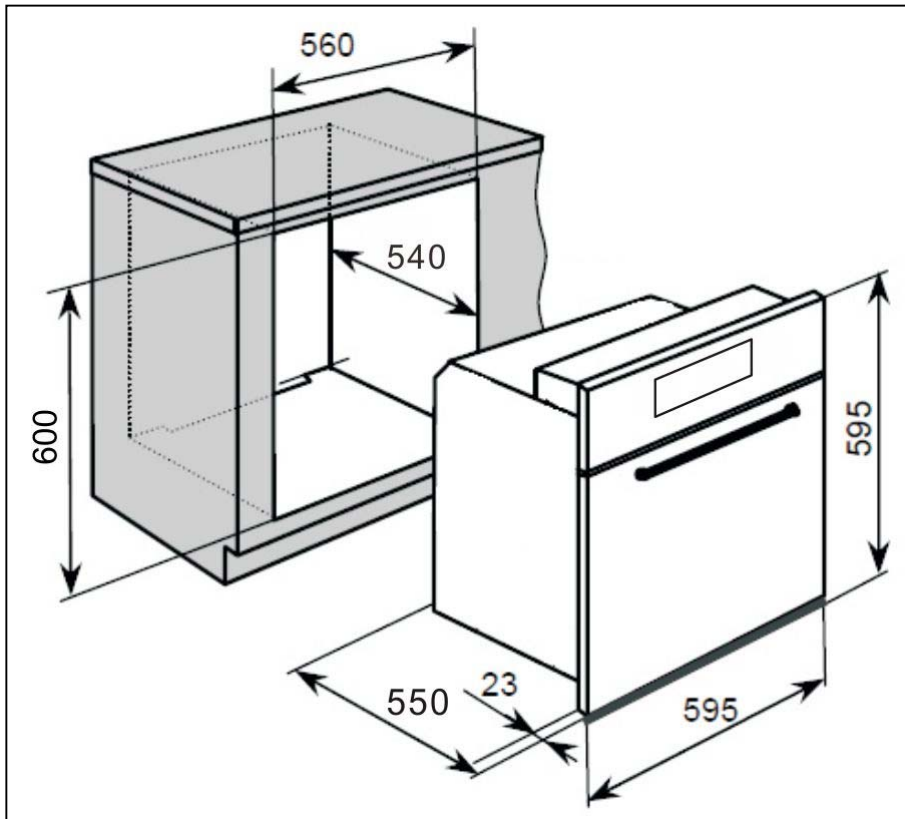

Product Dimensions

Height: 595 mm
Width: 595 mm
Depth: 550 mm

Aperture Dimensions

600 mm
560 mm
540 mm (min)

Product specifications

- 13 oven functions
- Energy efficiency class: A
- Oven net/gross capacity: 58/65 liters
- LCD display
- Cooling fan
- Thermostatically controlled grill
- Double-glazed removable door
- Removable inner door glass
- Oven light

Standard accessories

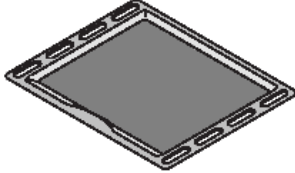
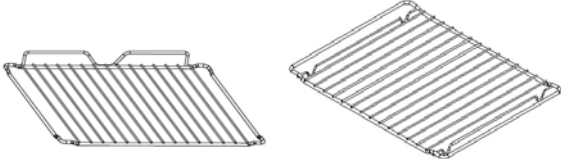
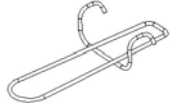
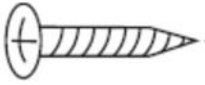
Accessory Name	Picture	Quantity
Baking tray		1
Grill		Each 1
Handle		1
Screws(ST4x35)		4

Electrical details

Rated Voltage:	220-240 Vac, 50/60 Hz
Supply Connection:	13A
Rated max power :	2.90 kW
Mains Supply Lead:	3 x 1.0mm ²
Oven Light Bulb:	25 W/300°C screw type pygmy







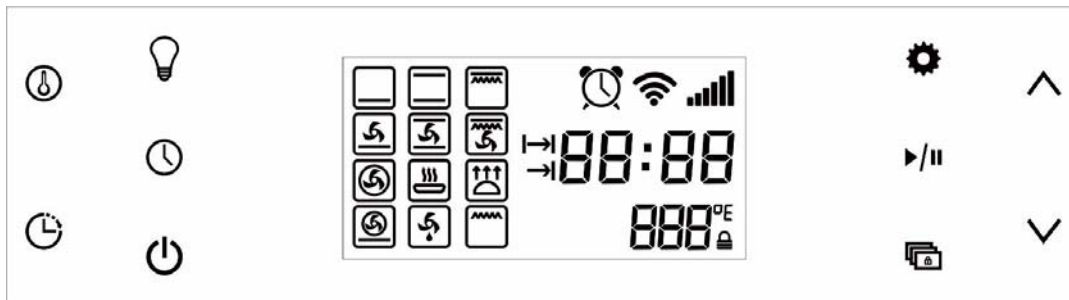



Cooling fan

- A tangential cooling fan is fitted inside of this appliance, to make the internal temperature of the oven stable and the external surface temperature lower.
- After you have finished cooking and switched off the oven, the cooling fan will continue to run for a period of time afterwards. The length of time will depend on how long the oven has been switched on for and at how high a temperature.





Control Panel



Touch-key

- | | |
|--|---|
|  Temperature button |  Duration button/End cook button |
|  Oven light button |  Clock setting button/Minute minder button |
|  Power button |  Automatic menu button |
|  Start/Pause button |  Function selection button |
|  Plus button |  minus button |

Icons on display

- | | |
|--|--|
|  Cooking duration function symbol |  Minute minder symbol |
|  End cooking function symbol |  Child lock symbol |
|  Temperature status indication symbol | |

Before first use

- To remove any residue from the oven that may have been left from the manufacturing process, you should select the fan oven function and set the thermostat to its maximum temperature setting.



- It is perfectly normal for a smell to be produced during this process.
- You should make sure that any windows in the room are left open during this process.
- It is advisable for you not to remain in the room whilst the burning off process is taking place.
- You should leave the oven on maximum setting for 30 – 40 minutes.
- After the oven cavity has cooled, it should then be cleaned with warm soapy water, using either a sponge or soft cloth. No abrasive cleaners should be used.
- Outer parts of the oven should be cleaned with warm soapy water, using either a sponge or soft cloth. No abrasive cleaners should be used.
- We would recommend that an appropriate stainless steel cleaner and polish is regularly used on the stainless steel surfaces of this appliance.





Setting and using the oven programmer/timer

After your appliance is connected to your mains supply for the first time, all icons and all key indicator lights will light up 3 seconds, then off except the power button. The display will show the default time "12:00" and start the timing.

- Press the power button  for two seconds, the oven will enter the standby mode. Now, you can set your oven.









Setting clock (the time of day)





- After pressing the Clock setting button , the hour digit of the time on the display will flash. Use the minus button  and plus button  to adjust the number.

- Press the Clock setting button  again, the minute digit of the time on the display will flash. Use the minus button  and plus button  to adjust the number.
- Press the Clock setting button  to confirm. Then the time will fix in the display.
- In the process of setting the clock, you can press the power button  to cancel the current setting.
- If you do not set the clock when you first use the oven, it will defaults to the system time of 12:00.
- You can not change the clock when the minute minder and the reservation function have been set.

Setting the minute minder function







You are able to set the minute minder at any time, regardless of whether an oven function has been selected.

- Press the minute minder button  for two seconds to set the alarm clock. The minute minder symbol  will flash.
- The display will show the current time. You can select the time of day that you wish the alarm rings. Adjust the hour digit of the time by using the minus  and plus  button.
- Press the minute minder button  again. Adjust the minute digit of the time by using the minus  and plus  button.
- Press the minute minder button  to confirm. The minute minder symbol  will fix in the display and the display will show the current time after a while.
- When the time is set, it is possible to shorten or lengthen the time by repeating the above steps.

- An alarm will sound 15 times when the setting time has elapsed and it will stop automatically after that.
- If you want to cancel the alarm, press the minute minder button  and set the time to **the current time** by using the minus  and plus  button. And press the minute minder button  to confirm.
- **Important:** The oven will continue to heat once the alarm has been silenced. If you have finished cooking, you can press the  start/pause button.







Setting the duration function

This function is similar to the minute minder function, however instead of selecting the time of day that you wish the oven to switch off at. You select a period of time that you wish the oven to switch off after.

- Select the cooking function and set the temperature that you require.
- Press the duration button  and the cooking duration function symbol  will flash. The display will show a value of 00:00. Set the period of the duration function to countdown for by the minus  and plus  buttons.
- Once the display has got to your desired countdown time, let go of the minus and plus buttons. Then press the  start/pause button to start to work. The Cooking duration function symbol  will fix in the display.
- Once a countdown time has been set, it is possible to shorten or lengthen the time by repeating the above steps.
- When the countdown time has elapsed and the oven will stop to heat. The cooking duration function symbol  will disappear.
- The setting range of cooking duration time is 00: 00 ~ 10: 00.





Setting the end cook function







This function will allow you to set the end of cooking time similar to the minute minder function. However the oven will no longer continue to heat, once the ending time has reached.

- Select the cooking function and set the temperature that you require.
- Press the end cook button  for two seconds, the display will show the current time. The End cooking function symbol  will flash. Set the time of day that you wish the oven to stop cooking at by using the minus  and plus  buttons.
- Once the display has got to the time of day that you want the oven to stop cooking at, let go of the minus and plus buttons. Then press the  start/pause button to start the work. The End cooking function symbol  will fix in the display.
- When the time is set, it can be modified by repeating the above steps.
- When the time of day reaches the ending time that you set, the oven will switch off and an alarm will sound. The End cooking function symbol  will disappear. The alarm can be silenced by pressing the end cook button.
- The setting range of End cook time is the current time+10 hours.

Setting the reservation function

This function will allow you to set a time in the future that the oven switches on at and a time that the oven will switch off at.

- Select the cooking function and set the temperature that you require.
- Press the duration button  and the display will show a value of 00:00. Set the period of time that you wish to cook for, by using the minus  and plus  buttons. The End cooking function symbol  will flash.
- Immediately press the end cook button  for two seconds and the timer display will show " the current time+the duration





- time+1 minute ". Set the time of day that you want the oven to switch off at, using the minus and plus buttons. The End cooking function symbol  will flash and the cooking duration function symbol  will fix in the display.
- Press the  start/pause button to confirm. The display will show the current time. The End cooking function symbol  and cooking duration function symbol  will flash.
 - The oven will calculate what time it needs to switch on at, so that your food will cook for the length of time that you selected. It will automatically switch itself on, once it reaches the time of day that it has calculated.
 - When the time of day reaches the end of cooking time that you set, the oven will switch off and an alarm will sound. The End cooking function symbol  and cooking duration function symbol  will disappear. The alarm can be silenced by pressing the end cook or duration button.

Selecting a cooking function and temperature



IMPORTANT: Make sure that you have sent your oven into manual operation mode before selecting an oven function and temperature.

Selecting the oven function

Press the  function selection button. Use the minus button  and plus button  to choose the functions. Release the minus or plus button after you choosing the correct function. The display will show the default temperature of the function that you have chosen. Pressing the  start/pause button, the oven will start to work without time limit.

Oven functions



Bottom Element:

Oven is heated using only the bottom element.



Bottom & Top Elements:

Allows the oven to be heated conventionally.



Combined grill (Grill and top heater):

When this function is activated, the grill heating tube and the top heater will work at the same time. This function allows roasting.



FAN, bottom

This setting only heats from the bottom, but with more evenly distributed temperature. Suitable for making fruit cakes and pies.



Fan, bottom and top heaters on:

When you choose this icon, the oven executes the cake function. Conventional oven with a fan.



Fan and combined grill on:

When you choose this function, the oven activates the combined grill and fan functions. This function can accelerate the process of barbecue and make food taste better.



FAN OVEN: This method of cooking uses the circular element while the heat is distributed by the fan. This results in a faster and more economical cooking process. The fan oven allows food to be cooked simultaneously on different

shelves, preventing the transmission of smells and tastes from one dish onto another.



Insulation function



Fermentation function



Intensive hot air (Rear heater with fan and bottom element on):

A crisp underside to pizza bases, quiches and pastry cases can be achieved by activating the intensive hot air setting. No need to preheat the oven when using this setting when cooking from frozen.



Defrosting:

This function allows all frozen foods to be rapidly and delicately thawed thanks to the internal fan.



Grill heater On:

Setting the knob to this position allows dishes to be grilled on the grate.

Note:

- 1) When the fermentation function is selected, the default temperature is not displayed.

Selecting the oven temperature

- o After you choosing the function, the display will show the default temperature. Press the temperature button , the number of the

default temperature will flash. Use the minus button ∇ and plus button \blacktriangle to adjust the temperature. After getting the display to the correct temperature, release the minus or plus button and the temperature will fix in the display.

- Pressing the $\blacktriangleright/\parallel$ start/pause button, the oven will start to work.
- If you want to change the temperature you have set, press the temperature button Ⓢ . The display will show the current temperature, then use the minus button ∇ and plus button \blacktriangle to adjust it. Press the start/pause button $\blacktriangleright/\parallel$ to confirm and the oven will restart to work.

Note:



- 1) When you setting the temperature, the temperature value will incremented or decremented every 5°C.
- 2) Temperature setting range: 50°C ~ 250°C.
- 3) Insulation temperature can be set to: 45°C, 60°C, 80°C.
- 4) Fermentation temperature is 40°C.
- 5) The defroster temperature is can be set to: 40°C ~ 80°C.







You should not place food inside the cavity, until the correct cooking temperature has been reached.

Child lock

- Press the function selection button Ⓢ for 3 seconds regardless of whether an oven is working. An alarm will sound once and the child lock symbol Ⓛ will appear on the display. The child lock have been set.
- In the locked state, all buttons can not be operated except the child lock button and the power button.

- You can unlock the child lock by pressing the function selection button  for 3 seconds. An alarm will sound once and the child lock symbol  will disappear. The child lock have been lifted.



Setting the automatic menu

- Press the automatic menu button  and choose the menu by using the minus  and plus  buttons.
- The number of the time on the display will show the code of the menu what you have chosen. The default function and temperature will appear on the display.
- Press the start/pause button  to confirm and start the work.
- The display will show the time required for the menu what you have chosen and starts the countdown.

Note:

- 1) The automatic menu can not be reserved.
- 2) Refer to **Schedule 1** for default cooking time, temperature and function.

Customize the menu

- After you setting of function、 temperature and cooking time, press the automatic menu button  for two seconds, the display will show "P40" as the code of the new menu.
- Press the start/pause button  to confirm and save the menu.

Note:

- 1) The new menu only can be named as "P40~P59". A total of 20 menus. The system will automatically calculate the new code sequence.
- 2) If you want to save a new menu after saving the "P59" menu, it will replace the "P40" menu automatically.

Schedule 1 (The automatic menu)

Code	Name of menu	Function	Temperature (°C)	Cooking time
P01	8-inch Chiffon Cake		155	40min
P02	Chiffon roll		180	16min
P03	Egg Tart		195	26min
P04	Cheese Cake		170	60min
P05	Lava Cake		190	13min
P06	Muffin Cake		170	30min
P07	Toast		165	30min
P08	Bun		175	14min
P09	Pizza		190	20min
P10	Thawed meat		80	30min
P11	Cookies		175	16min
P12	Puff		200	25min
P13	Mutton shashlik		200	15min
P14	Roast leg of lamb		210	45min
P15	Macaroon		160	16min
P16	Roast chicken wings		200	25min
P17	Roast fish		180	25min
P18	Yogurt		40	4h

Cooking guidelines

- Please refer to the information given on food packaging for guidance on cooking temperatures and times. Once familiar with the performance of your appliance, temperatures and times can be varied to suit personal preference.
- If you are using the fan oven function, then you should follow the information given on the food packaging for this particular mode of cooking.
- You should preheat the oven and not place food inside of it until the oven operating light has gone off. You can choose not to preheat when using the fan oven mode; however you should extend the cooking time given on the food packaging by at least ten minutes.
- ***IMPORTANT:*** *You should ALWAYS preheat the oven if you are baking.*
- If there is no guidance given on the food packaging specifically for cooking in fan oven mode, you can generally reduce the cooking time and temperature by 10% from the information given for conventional oven cooking.
- Make sure that frozen foods are thoroughly thawed before cooking, unless the instructions on the food packaging advise that you can “cook from frozen”.
- Before cooking, check that any accessories that are not required are removed from the oven.
- Place cooking trays in the center of the oven and leave gaps between the trays to allow air to circulate.
- Try to open the door as little as possible to view the dishes.
- The oven light will remain on during cooking.

Warnings

- Keep the oven door closed when using **any** of the cooking functions, ***including*** the grill functions.

- Do not use aluminium foil to cover the grill pan or heat items wrapped in aluminium foil under the grill. The high reflectivity of the foil could potentially damage the grill element.
- You should also never line the base of your oven with aluminium foil.
- During cooking, never place pans or cookware directly onto the bottom of your oven. They should always be placed on the shelves provided.
- The internal components of the oven become extremely hot during operation, care should be taken avoid touching them inadvertently.
- **Important:** Be careful when opening the door, to avoid contact with hot parts of the oven and steam.
- When removing any item from the oven, you should **ALWAYS** use an oven glove.
- **Warning:** Accessible parts may become hot during use. Young children should be kept well away from the oven when it is in use.

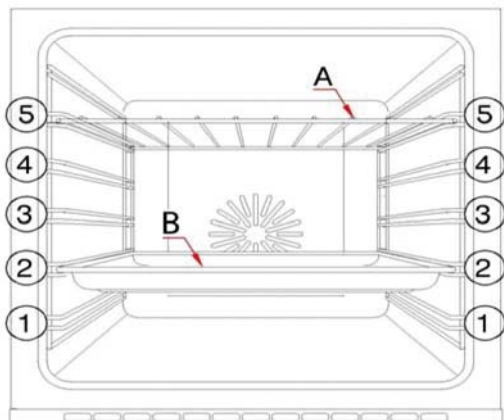

Shelf positions

Your oven will come supplied with the following oven furniture:

- (A) Oven shelf
- (B) Enamelled baking tray & trivet

- The numbers 1 – 5, indicate the different shelf positions that you can utilise within the oven.

(Image for reference only – actual product may differ slightly)

- The sides of the cavity are moulded to provide positions for the shelves or enamelled baking tray to rest on. Ensure that you select a shelf position at the same height on both sides of the cavity. The oven shelf has safety stops to prevent accidental withdraw. After engaging the oven shelf into the side racks, as you push the oven

shelf into the oven, lift the front of the shelf slightly to bypass the stops and allow the oven shelf to slide fully into the racks.

- To remove the oven shelf, gently pull the oven shelf outwards. When the shelf stops, lift the front slightly to bypass the safety stops and then completely withdraw the oven shelf from the oven.
- When installed correctly, the shelf and tray should be horizontal and not on an angle.

Cleaning and maintenance



Cleaning operations must only be carried out when the oven is cool.

The appliance should be disconnected from your mains supply before commencing any cleaning or maintenance process.

- The oven should be thoroughly cleaned before it is operated for the first time and after each use. This will avoid residual food stuffs becoming baked on the oven cavity. After residues have been baked on several times, they are far more difficult to remove.
- **Never** clean the oven surfaces by steam cleaning.
- The oven cavity should only be cleaned with warm soapy water, using either a sponge or soft cloth. No abrasive cleaners should be used.
- Any stains that may appear on the bottom of the oven will have originated from food splashes or spilt food, these splashes occur during the cooking process. These could possibly be a result of the food being cooked at an excessively high temperature or being placed in cookware that is too small.

- You should make sure that the cooking temperature that is selected is appropriate for the food that you are cooking. You should also ensure that the food is placed in an adequately sized dish and use the enamelled baking tray where appropriate.
- Outer parts of the oven should only be cleaned with warm soapy water, using either a sponge or soft cloth. No abrasive cleaners should be used.
- We would recommend that an appropriate stainless steel cleaner and polish is regularly used on the stainless steel surfaces of this appliance.
- If you use any form of oven cleaner on your appliance, then you must check with the manufacturer of the cleaner that it is suitable for use on your appliance.
- Do not use harsh or abrasive cleaners or sharp metal scrapers to clean the oven door glass since they can scratch the surface which may result in shattering.
- ***Any damage that is caused to the appliance by a cleaning product will not be fixed by the manufacturer free of charge, even if the appliance is within the guarantee period.***
- Your appliance must be disconnected from your mains supply before replacing the oven light bulb, to avoid the possibility of electric shock.

Replacing the oven bulb



IMPORTANT: The oven must be disconnected from your mains supply before you attempt to either remove or replace the oven bulb.

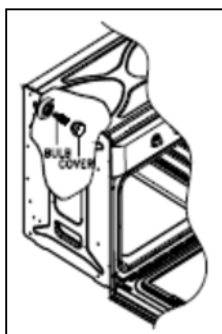

- Remove all oven shelves, the drip tray and the side rack that is on the same side as the oven light.
- Remove the light cover by turning it anti-clockwise.
- Unscrew the bulb anti-clockwise and remove it from its holder.

- Replace the bulb with a 25 W/300°C, screw type pygmy.
- **Do not** use any other type of bulb.
- Place the lamp cover back into position.

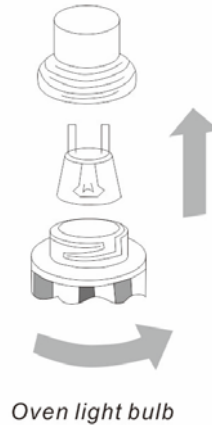

Removing the oven door for cleaning

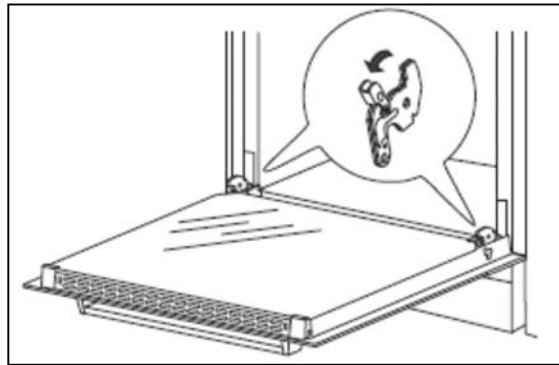

To facilitate the cleaning of the inside of the oven and the outer frame of the oven, the door can be removed as follows:

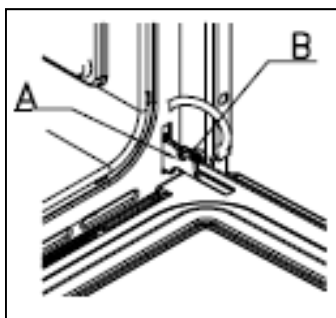

- The hinges **(A)** have two movable bolts on them **(B)**.
- If you raise both of the movable bolts **(B)**, then the hinges **(A)** are released from the oven housing.
- You should grip the sides of the door at the centre and then incline it slightly towards the oven cavity and then pull the door gently away from the oven cavity.

- **IMPORTANT:** You should make sure that the door is supported at all times and that you place the door on some padded material whilst cleaning it.
- The oven door and door glass should only be cleaned using a damp cloth and a small amount of detergent. The cloth **MUST NOT** have come into contact with any form of cleaning product or chemical previously.
- To refit the door you should slide the hinges back into their slots and open the door fully.
- **IMPORTANT:** The movable bolts (**B**) must be closed back into their original positions before closing the door.



- **Take care not to dislodge the hinge locking system when removing the door, as the hinge mechanism has a strong spring.**
- **Do not immerse the door in water at any time.**

Removing the inner door glass for cleaning

- Do not use any abrasive cleaner that could cause damage.
- Remember that if the surface of the glass panel becomes scratched, this could lead to a dangerous failure.
- To facilitate cleaning, the inner door glass can be lifted out.

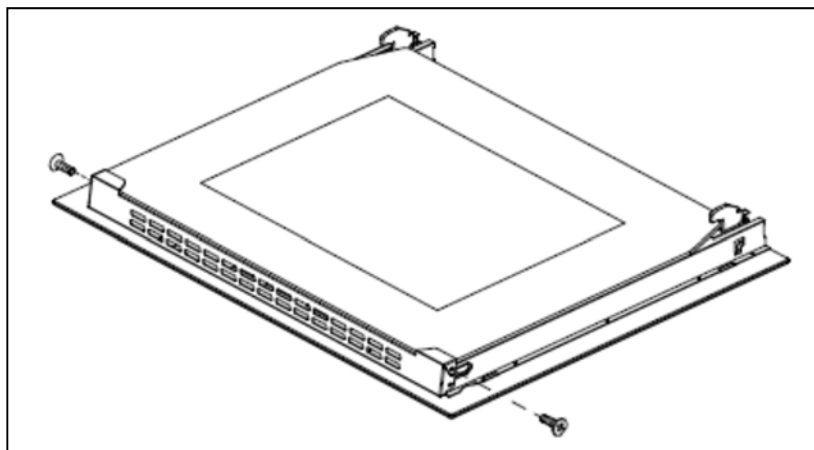

- Unscrew the bracket latch that is in the corner of the top of the door. Remove the glass from the door and clean with warm soapy water.
- After cleaning, insert the glass panel correctly back into the door. Screw the bracket latch back into place.
- ***IMPORTANT: Remember where the panel of glass is removed from so you can reassemble the door correctly. Do not mix the glasses up or rearrange the order.***

INSTALLATION



The installation must be carried out by a suitably qualified person, in accordance with the current version of the following.

- ***UK Regulations and Safety Standards*** or their European Norm Replacements.
- ***Building Regulations*** (issued by the Department of the Environment).
- ***Building Standards*** (issued by the Scottish Development Department).
- ***IEE Wiring Regulations.***
- ***Electricity At Work Regulations.***

Electrical connection

Before connecting the appliance, make sure that the supply voltage marked on the rating plate corresponds with your mains supply voltage.

WARNING: THIS APPLIANCE MUST BE EARTHED.

- This appliance should be wired into a 10A double pole switched fused spur outlet, having 3 mm contact separation and placed in an easily accessible position adjacent to the appliance. The spur outlet must still be accessible even when your oven is located in its housing.

MAINS
POWER
SUPPLY

LIVE	L
EARTH	
NEUTRAL	N

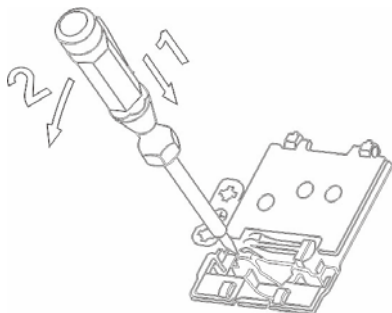
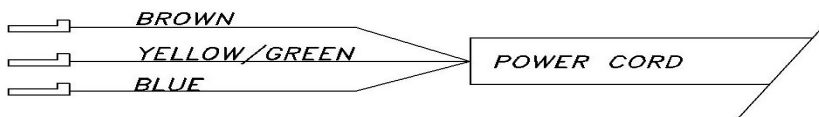



○ To connect the oven power cord, remove the cover on the terminal block, in order to gain access to the contacts inside. Make the connection, securing the cord in place with the cable clamp provided and then immediately close the terminal block cover again.

CONNECTION DIAGRAM

Caution! Voltage of heating elements 220V~240V

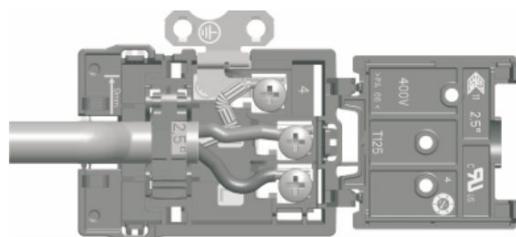
Caution! In the event of any connection the safety wire must be connected to the  PE terminal



For 220V-240V earthed one phase connect on: Brown wire connect to L and blue wire connect to N, safety wire (Yellowgreen) connect to 

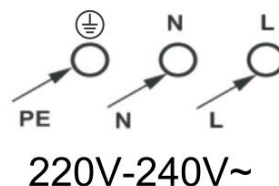

- Connect the wires as indicated in the image above, using the brass links provided where necessary.
- The earthing (yellow/green) conductor must always be 10 mm longer than the line conductors.
- Care must be taken to ensure that the temperature of the mains supply cable does not exceed 50°C.
- Regularly check the power cord for damage. If the supply cord is damaged, it must be replaced by the manufacturer, its service agent or similarly qualified persons in order to avoid a danger or injury.

Installing the oven into the kitchen cabinet

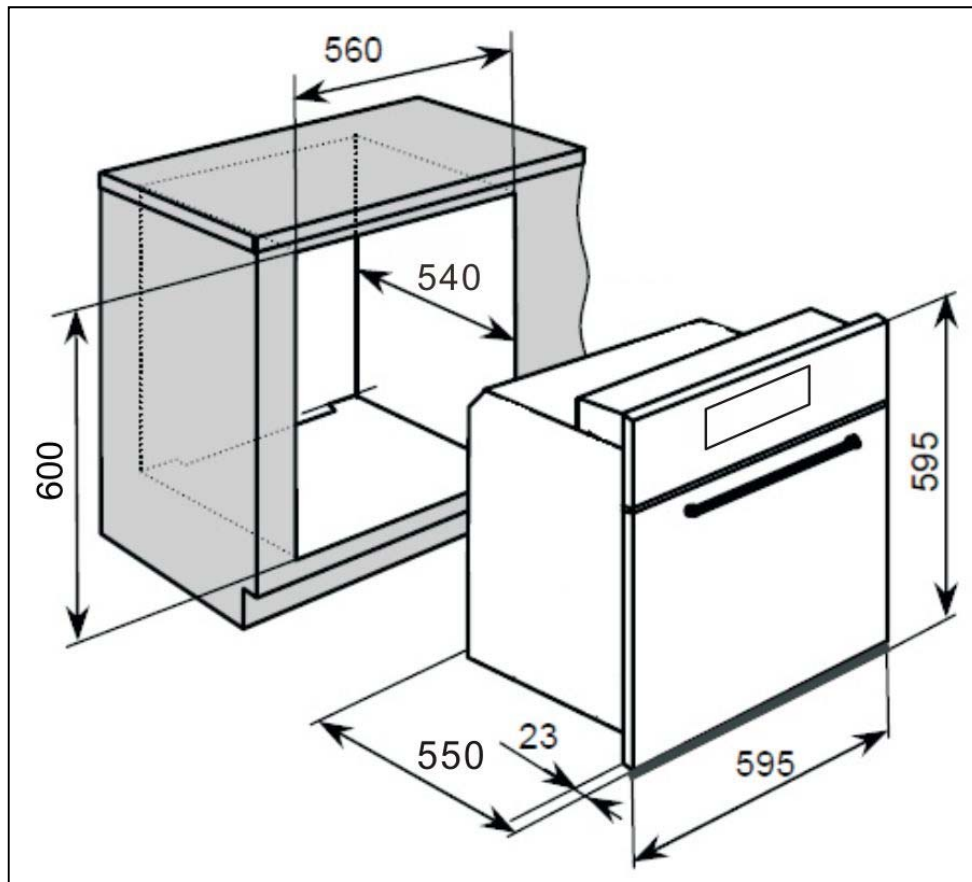

Positioning the appliance

- Ensure that the aperture that you will be fitting the oven into is of the size given in the above diagram.
- The oven must be fitted into an oven housing with the ventilation cut-outs shown in the "Ventilation requirements" section on the next page.
- Ensure that the rear panel of the furniture housing unit has been removed.

Ventilation requirements

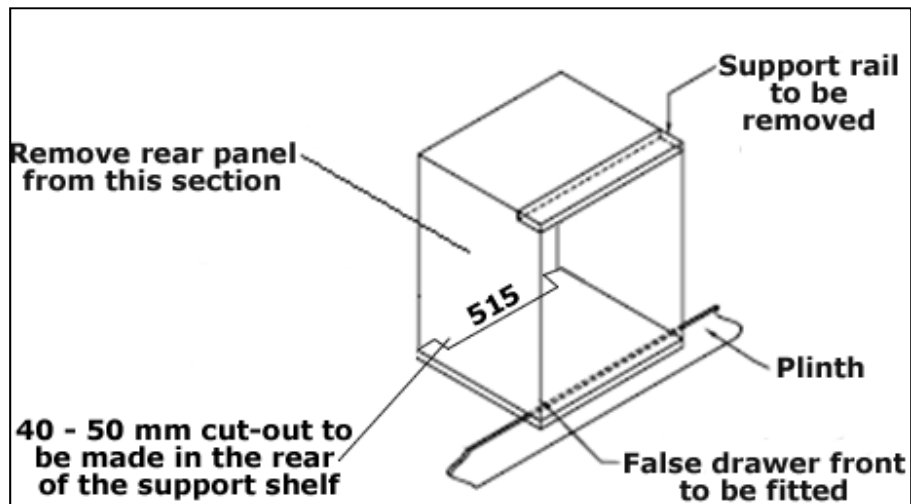

(Figure shows the ventilation and cut-out requirements for the installation of the appliance into a standard kitchen unit).

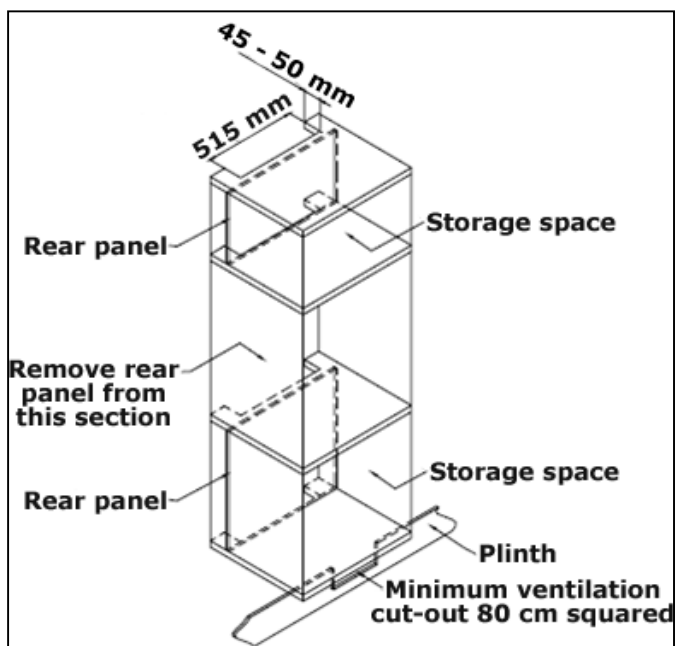

(Figure shows the ventilation and cut-out requirements for the installation of the appliance into a tall housing unit).

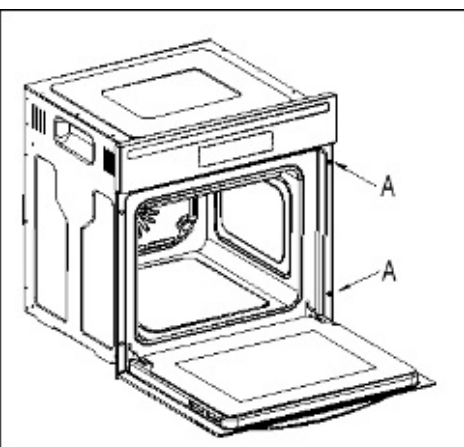

- o Ensure that the oven has been securely fixed into the housing unit. The fixing of the oven into the housing is made by using four screws. These should be screwed through the oven cabinet and into the housing unit.

My appliance isn't working correctly

- ***The oven isn't coming on.***
 - * Check that the oven is in manual operation mode.
 - * Check that you have selected a cooking function and a cooking temperature.
- ***There appears to be no power to the oven and grill.***
 - * Check that the appliance has been connected to the electrical mains supply correctly.
 - * Check that the mains fuses are in working order.
 - * Check that the operating instructions for putting the appliance into manual operation mode have been followed.
- ***The grill function works but the main oven does not.***
 - * Check that you have selected the correct cooking function.
- ***The grill and top oven element is not working, or cuts out for long periods of time during use.***
 - * Allow the oven to cool for approximately 2 hours. Once cool, check whether the appliance is again working properly.
- ***My food is not cooking properly***
 - * Ensure that you are selecting the correct temperature and the correct cooking function for the food that you are cooking. It may be appropriate to adjust your cooking temperature by plus or minus 10°C, to achieve the best cooking results.
- ***My food is not cooking evenly***
 - * Check that the oven has been installed correctly and is level.
 - * Check that the correct temperatures and shelf positions are being used.
- ***The oven light is not working***

- * Refer to the "Replacing the oven bulb" section.
- o ***I am getting condensation in my oven***
- * Steam and condensation is a natural by product of cooking any food with high water content, such as frozen food, chicken etc.
- * You may get condensation in the oven cavity and forming between the oven door glasses. This is not necessarily a sign that the oven is not working correctly.
- * Do not leave food in the oven to cool after it has been cooked and the oven has been switched off.
- * Use a covered container, where practical, when cooking to reduce the amount of condensation that forms.



IMPORTANT: If your appliance appears not to be operating correctly, then you should disconnect it from your mains supply and then contact the Customer Care Department .

DO NOT ATTEMPT TO REPAIR THE APPLIANCE YOURSELF.

Please note that if an engineer is asked to attend whilst the product is under guarantee and finds that the problem is not the result of an appliance fault, then you may be liable for the cost of the call out charge.

The appliance must be accessible for the engineer to perform any necessary repair. If your appliance is installed in such a way that an engineer is concerned that damage will be caused to the appliance or your kitchen, then he will not complete a repair.

This includes situations where appliances have been tiled in, sealed in with sealant, have wooden obstructions placed in front of the appliance - like plinths, or any installation other than the one specified by the manufacturer has been completed.

Please refer to the conditions of guarantee that appear on the warranty card that you receive with the appliance.

IMPORTANT: The manufacturer operates a policy of continuous improvement and reserves the right to adjust and modify its products without prior notification.

Customer Service

To arrange an in guarantee service call, please contact customer services on the following numbers.

**UK and N.Ireland – Telephone 0344 800 1128
E mail: uksupport@apelson.co.uk
Spares and Accessories: www.spareszone.co.uk**

**Republic of Ireland-- Telephone 014475261
E mail: uksupport@apelson.co.uk
Spares and Accessories: www.spareszone.co.uk**

AA UK Ltd
Unit 3 Normandy Landings
Pope Street
Castleford
WF6 2AG